



55i IP Phone

User Guide
Release 2.0

41-001200-00

Rev 01

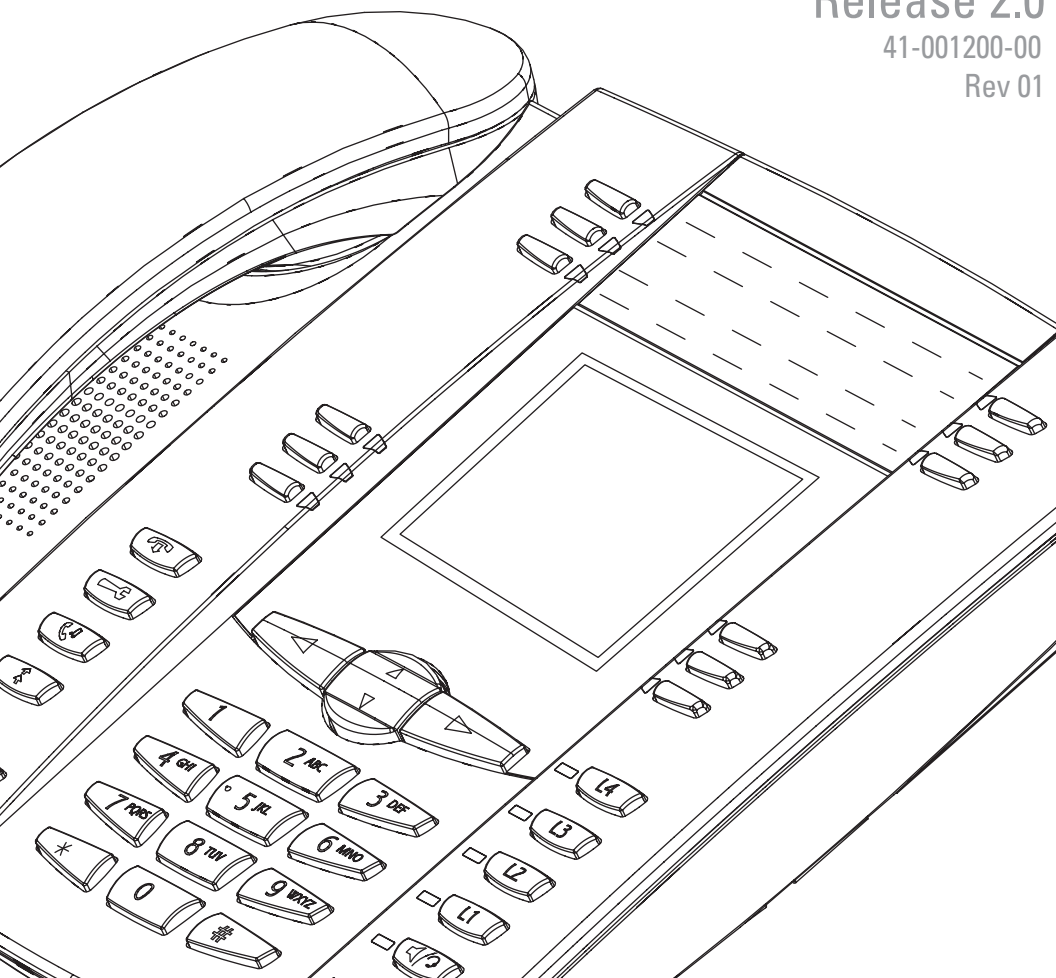

Aastra Telecom will not accept liability for any damages and/or long distance charges, which result from unauthorized and/or unlawful use.

While every effort has been made to ensure accuracy, Aastra Telecom will not be liable for technical or editorial errors or omissions contained within this documentation. The information contained in this documentation is subject to change without notice.



Software License Agreement

Aastra Telecom Inc., hereinafter known as "Seller", grants to Customer a personal, worldwide, non-transferable, non-sublicenseable and non-exclusive, restricted use license to use Software in object form solely with the Equipment for which the Software was intended. This Product may integrate programs, licensed to Aastra by third party Suppliers, for distribution under the terms of this agreement. These programs are confidential and proprietary, and are protected as such by copyright law as unpublished works and by international treaties to the fullest extent under the applicable law of the jurisdiction of the Customer. In addition, these confidential and proprietary programs are works conforming to the requirements of Section 401 of title 17 of the United States Code. Customer shall not disclose to any third party such confidential and proprietary programs and information and shall not export licensed Software to any country except in accordance with United States Export laws and restrictions.

Customer agrees to not reverse engineer, decompile, disassemble or display Software furnished in object code form. Customer shall not modify, copy, reproduce, distribute, transcribe, translate or reduce to electronic medium or machine readable form or language, derive source code without the express written consent of the Seller and its Suppliers, or disseminate or otherwise disclose the Software to third parties. All Software furnished hereunder (whether or not part of firmware), including all copies thereof, are and shall remain the property of Seller and its Suppliers and are subject to the terms and conditions of this agreement. All rights reserved.

Customer's use of this software shall be deemed to reflect Customer's agreement to abide by the terms and conditions contained herein. Removal or modification of trademarks, copyright notices, logos, etc., or the use of Software on any Equipment other than that for which it is intended, or any other material breach of this Agreement, shall automatically terminate this license. If this Agreement is terminated for breach, Customer shall immediately discontinue use and destroy or return to Seller all licensed software and other confidential or proprietary information of Seller. In no event shall Seller or its suppliers or licensors be liable for any damages whatsoever (including without limitation, damages for loss of business profits, business interruption, loss of business information, other pecuniary loss, or consequential damages) arising out of the use of or inability to use the software, even if Seller has been advised of the possibility of such damages.

Table of Contents

Software License Agreement	iii
About this Guide	1
Documentation	1
Introduction	2
Phone Features	2
Requirements	2
Installation and Setup	2
Getting Started	3
Plugging in and Starting the Phone	3
Network Connected/Network Disconnected	7
Idle Screen	8
Phone Options via the IP Phone UI	12
References	13
Phone Options via the Aastra Web UI	14
User Password	18
Using Your Phone	20
Key Descriptions	20
Multiple Line and Call Appearances	23
Softkeys and Programmable Keys	24
Softkey Functions	25
State-Based Softkeys (Bottom Keys only)	27
Softkeys as Line/Call Appearances	28
Softkeys as Speeddials	32
Softkeys as "Do not Disturb"	37
Softkeys as Busy Lamp Field (BLF)	39
Softkeys as BLF List	41
Softkeys for Accessing XML Services	44
Softkeys as Flash Key	50
Softkeys as Sprecode	52
Static and Softkey Settings for Park/Pickup	54
Softkeys as Last Call Return (lcr) (Sylantro Servers only) .	60
Softkeys as Services	62
Softkeys as Directory	65
Softkeys as Callers List	68
Softkeys as an Intercom Key	71
Softkeys as an Empty Key	74
Deleting a Softkey	76
Restarting your phone	78

Table of Contents

Making Calls	79
Dialing a Number	79
Pre-dialing a Number	79
Using Handsfree Speakerphone	80
Using a Headset	80
Intercom	82
Redial	84
Mute	85
Receiving Calls	86
Answering an Incoming Call	86
Sending an Incoming Call to Voicemail	86
Handling Calls	87
Placing a Call on Hold	87
Transferring Calls	89
Conferencing Calls	90
Picking up Calls	92
Managing Calls	93
Directory List	93
Callers List	100
Call Forwarding	105
Missed Calls Indicator	108
Voicemail	109
Additional Features	110
Star Codes	110
Suppressing DTMF Playback	110
Display DTMF Digits	111
Stuttered Dial Tone	112
Play Call Waiting Tone	113
Incoming Intercom Calls and Auto-Answer	114
Using Redial Key for “Last Number Redial”	115
Ring Tones and Tone Sets	116
Time and Date	120
Locking and Unlocking the Phone	124
Resetting a User Password	126
Defining an Emergency Dial Plan	127
Language	129
Specifying the Language to Use	129
Model 536 Expansion Modules (536EM)	131
Troubleshooting Solutions	132
Limited Warranty	135
Appendix A - Time Zone Codes	A-1

About this Guide

This guide explains how to use the basic features of your new 55i phone. Not all features listed are available by default. Contact your system or network administrator to find out which features and services are available to you on your system.

Your system administrator has the ability to customize some features on this phone. For information on more advanced settings and configurations, administrators should refer to the ***Aastra SIP 53i, 55i, 55i, and 55i CT IP Phone Administration Guide***.

Documentation

- ***Aastra 55i IP Phone Installation Guide*** – Installation and set-up instructions, general features and functions, and basic options list customization. This Installation Guide is included with the telephone.
- ***Aastra 55i IP Phone User Guide*** – Describes the most commonly used features and functions for an end user.
- ***Aastra 53i, 55i, 57i, and 57i CT IP Phone Administration Guide*** – Describes how to set the 55i phone up on the network and contains advanced configuration instructions for the 55i. This guide has instructions that are at a user level.

Introduction

This 55i IP telephone has all the features of a regular business phone, allowing you to make and receive calls, transfer, conference and more. The 55i IP telephone provides communications over an IP Network using the SIP IP telephony protocol.

Phone Features

- 8 line graphical LCD screen (144 x 75 pixels) with white backlight
- 12 programmable keys
 - 6 Top keys: Programmable hard keys (up to 6 programmable functions)
 - 6 Bottom keys: Programmable state-based softkeys (up to 20 programmable functions)
- 4 call appearance lines with LEDs
- Supports up to 9 call lines
- Full-duplex speakerphone for handsfree calls
- Headset support (modular connector)
- Built-in-two-port, 10/100 Ethernet switch - lets you share a connection with your computer.
- Inline power support (based on 802.3af standard) which eliminates power adapters.
- AC power adapter (included)
- Enhanced busy lamp fields*
- Set paging*

* Availability of feature dependant on your phone system or service provider

Requirements

The 55i IP Phone requires the following environment:

- SIP-based IP PBX system or network installed and running with a SIP account created for the 55i phone.
- Access to a Trivial File Transfer Protocol (TFTP), File Transfer Protocol (FTP), Hypertext Transfer Protocol (HTTP) server, or Hyper Text Transfer Protocol over Secure Sockets Layer (SSL) (HTTPS).
- 802.3af Ethernet/Fast Ethernet LAN
- Category 5/5e straight through cabling
- Power over Ethernet (PoE) inline power injector (optional accessory - necessary only if your network provides no inline power and if you do not use the IP Phone's power adapter).

Installation and Setup

If your system administrator has not already setup your 55i phone, please refer to the ***Aastra 55i Installation Guide*** for basic installation and physical setup information. For more advanced administration and configuration information, system administrators should refer to the ***Aastra SIP 53i, 55i, 57i, 57i CT IP Phone Administrators Guide***.

Getting Started

The 55i must be set up and be configured prior to its first use. This section describes phone behavior and start up screens you may see when the phone is first plugged in, or when it is restarted.

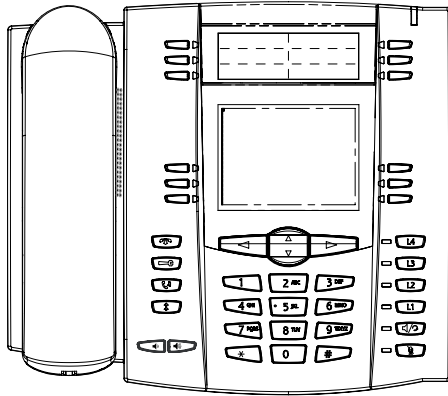

Plugging in and Starting the Phone

The 55i automatically begins the start up sequence as soon as it is connected. The phone goes through this process the first time you plug in your phone and every time you restart your phone.

The phone displays the following startup screens.





The 55i phone then checks settings and looks for new configuration and firmware updates for the phone from a server. If a new update is found, the phone displays the message “Updating Configuration”. This may take a few moments while the phone downloads the latest updates.



Note: New updates to your phone can be automatically scheduled from the server. This is set up on the phone system by your system administrator and should be scheduled during non-business hours or slow call periods.

Important! Do not unplug or remove power to the phone while it is checking or installing firmware and configuration information.

If language packs were loaded to your phone by your system administrator, the following screen displays during startup.



When the configuration update is complete, the phone displays the following screens and then displays the Idle screen..



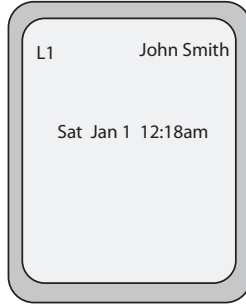

Idle Screen

Network Connected/Network Disconnected

If your phone is successful when connecting to the network the following screen displays before changing to the Idle screen..

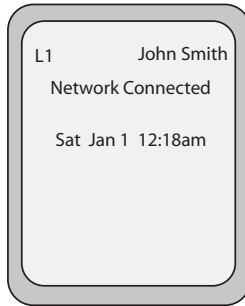

If your phone did not successfully connect to the network, the "**Network Disconnected**" prompt appears on the display and the telephone status light turns on.

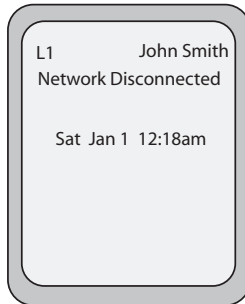

Check that the cables are tightly connected to the phone and to the wall jack. The phone should automatically detect when it is reconnected and displays the "**Network Connected**" prompt for a few seconds. However, if changes have been made to your phone's network settings, you may need to restart your phone.

For more information about connecting your phone, see the ***Aastra 55i IP Phone Installation Guide***, the section "**Connecting to the Network and to Power**".

Check with your system or network administrator for assistance.

Note: If the phone displays "No Service" you can still use the phone but it is not registered with the Registrar. For more information about registering your phone, see your system administrator.

Idle Screen

When the phone has successfully updated the configuration and connected to the network, the phone displays the **Idle State** screen. The idle screen is shown whenever your phone is not in use.

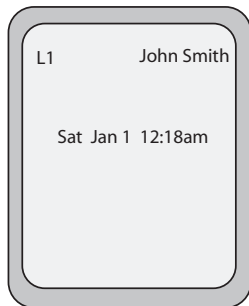

Note: Your system administrator sets up your SIP screen name, line number, and any other administrative features required. If your name does not display on the screen, contact your system administrator.

The **Idle State** screen lists your name (SIP screen name) and day, date, and time. In the above screen, the "L1" indicates John Smith is configured on Line 1.

By default, the top programmable keys 1 through 4 are configured for Services, Directory, Callers List, and Intercom, respectively. You can configure the 6 top programmable keys with up to 6 functions, and the 6 bottom softkeys with up to 20 functions as required.

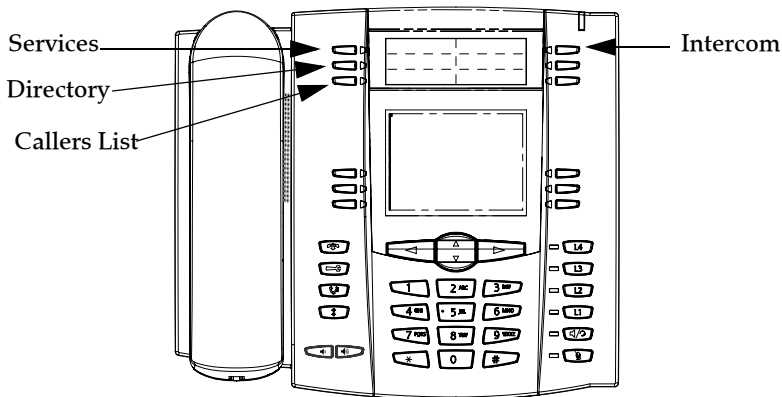

Reference

For more information about configuring the top programmable keys and the bottom softkeys, see ["Softkeys and Programmable Keys"](#) on page 24.

For more information about using the Services, Directory, Callers List, Intercom, Dial, Conference, and Transfer keys, see the following sections:

- ["Making Calls"](#) on page 79.
- ["Handling Calls"](#) on page 87.
- ["Managing Calls"](#) on page 93.

Idle Screen With Softkeys/Programmable Keys Configured

If you or your administrator have configured softkey functions on your phone, the labels for those functions display on the screen. Programmable key functions (top keys) do not display on the LCD. For example, in the following illustration, "Home" and "Office" were configured as speeddial keys on the bottom set of softkeys and "Do Not Disturb" (DND) was configured on the top set of programmable keys.

Note: The top programmable key descriptions do not display on the LCD. You can write the function assigned to the programmable key using the label provided for the phone..

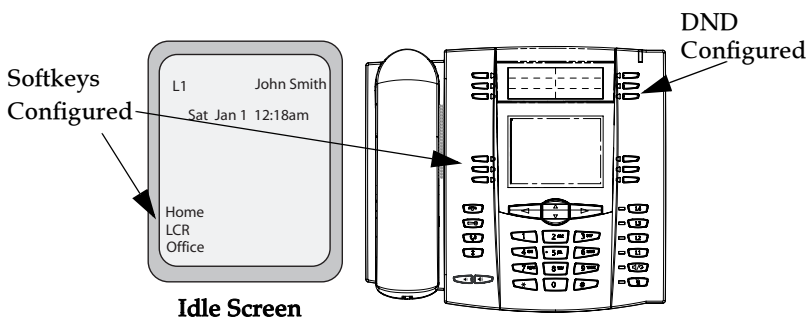

Idle Screen with Voicemail Messages

The envelope icon  displays on the Idle State screen only if you have new messages waiting. The number next to the envelope indicates how many new messages you have.

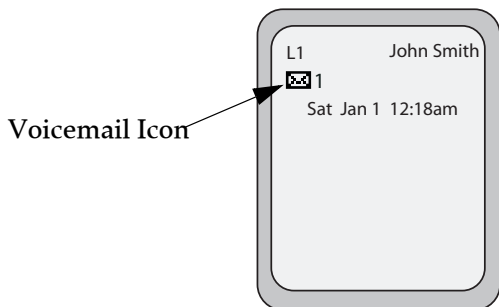

Idle Screen

To access your voicemail messages, use the star codes for your system if a voicemail softkey has not been configured on your phone. For more information on your system's star codes, please refer to the documentation for the voicemail system you are using.

Screen Display After Picking Up the Handset

When you pick up the handset, the screen displays as follows:

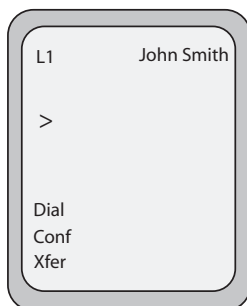

This screen displays the following keys located on the bottom left of the screen:

- Dial
- Conference
- Transfer

These keys are static and cannot be changed.

A **More** softkey also displays at the bottom right of the screen if you have configured softkeys.

For example, in the illustration below, the 55i has several bottom softkeys configured on the idle screen. A **More** key displays for you to view additional softkeys on another screen. Also, if you pick up the handset, a **More** displays for you to view additional softkeys. You can press the **More** softkey to toggle between the first and second screens to display all configured softkeys.

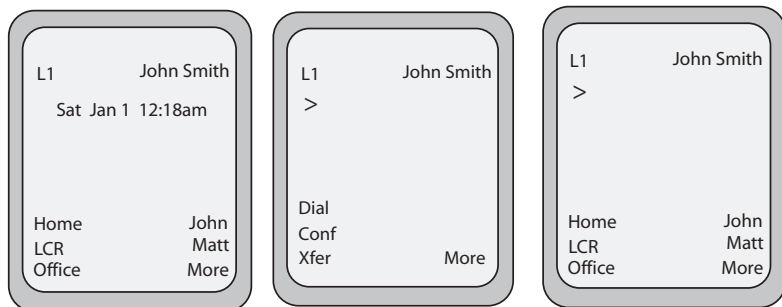

Idle Screen

After Handset Pickup

After Pressing "More"

Note: The bottom set of 6 softkeys map to the current state-based configurable softkeys.

Phone Options via the IP Phone UI







You can access specific options for the 55i IP phone using the phone's user interface (UI) via the keypad. Pressing the Option button  gives you a list of configurable options.

These options allow you to customize your phone settings.

1	Language
2	Time and Date 1 Time Server 2 Set Time 3 Time Format 4 Set Date 5 Date Format 6 Time Zone 7 Daylight Savings
3	Tones 1 Set Ring Tone 2 Tone Set
4	Clear Msg. Wtg.
5	Display 1 Contrast Level 2 Backlight
6	Live Dialpad
7	Set Audio Audio Mode Advanced Setting Headset Mic Volume
8	Call Forward Number: Mode: No. Rings:
9	Network*
10	SIP Settings*
11	Phone Status 1 Network Status 2 Firmware Version 3 Restart Phone 4 Factory Default*
12	User Password
13	Phone Lock

Note: *The "Network" and "SIP Settings" options are administrator level functions only, and are not accessible by the user. Under the "Phone Status" option, the "Factory Default" selection is also an administrator level function only. These options should only be set up and changed by your system administrator.



1. Press the Options key  on the phone to enter the options list.
2. To go to an **Option**, use  and  to scroll through the list, or press the number corresponding to the **Option**.
3. Press the **Show** softkey, the  button, or press the digit number of the corresponding option to select an option.
4. Use the softkeys that display for each option to change a selected option.
5. Press the **Done** button to save the change.
6. Press the  button, the  button, or the  button at any time to exit without saving changes.

References

For more information about customizing your phone using the available options from the IP Phone UI, see the section "**Customizing Your Phone**" in the *Aastra 55i Installation Guide*.

For more information about administrator options, contact your system administrator.

Phone Options via the Aastra Web UI

In addition to the IP Phone UI options, you can also customize additional options on the IP Phone using the Aastra Web UI. In order to access your phone using the Aastra Web UI, you need to know your phone's IP address.

Finding Your Phone's IP Address



IP Phone UI

1. Press to enter the Options List.
2. Use to scroll down the list of options to **Phone Status** and press **Show**.

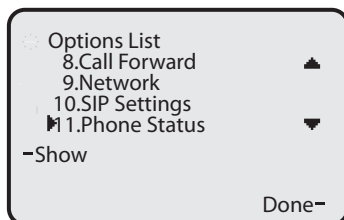

3. Use to scroll to **Network Status** and press **Show**.

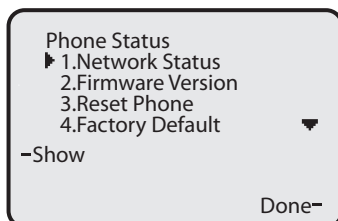

4. Press **IP Addr.**

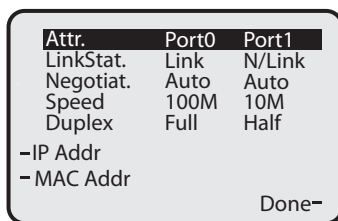

5. Your phone's IP Address displays.

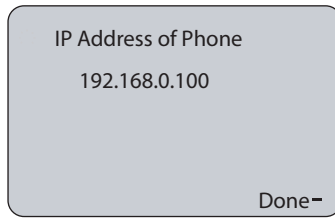

Using the Aastra Web UI



Aastra Web UI

1. Open your web browser and enter the phone's IP address or host name into the address field.

If the browser is using HTTP, the following redirect screen displays, followed by the "Security Alert" window. This process redirects HTTP to use HTTPS for a more secure connection..

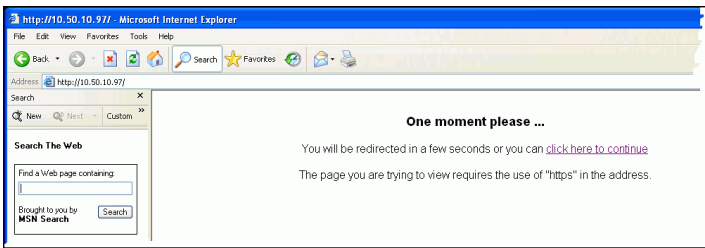

2. Click **YES** to accept the certificate
3. At the prompt, enter your username and password and click 

The Network Status window displays for the IP phone you are accessing.

Note: For a user, the default user name is “user” and the password field is left blank. The Network Status window displays for the IP phone you are accessing.

Attribute	Port 0	Port 1
Link State	Up	Down
Negotiation	Auto	Auto
Speed	10Mbps	10Mbps
Duplex	Half	Half

MAC Address:	00-08-5D-16-10-F4
--------------	-------------------

Attribute	Value
Platform	55i Revision 0

Attribute	Value
Firmware Version	2.0.1.1076
Firmware Release Code	SIP
Boot Version	1.1.0.1225
Date/Time	Jan 8 2007 18:34:40

4. You can logout of the Aastra Web UI at any time by clicking **Log Off**.

The following categories display in the side menu of the Aastra Web UI: **Status, Operation, Basic Settings**.

Status

The **Status** section displays the network status and the MAC address of the IP phone. It also displays hardware and firmware information about the IP phone. The information in the Network Status window is read-only.

Operation

The **Operation** section provides the following options:

- **User Password** - Allows you to change user password
- **Phone Lock** - Allows you to assign an emergency dial plan to the phone, lock the phone to prevent any changes to the phone and to prevent use of the phone, and reset the user password.
- **Softkeys and XML** - Allows you to configure up to 6 bottom softkeys for a specific function (none, line, speedial, do not disturb (DND), Busy Lamp Field (BLF), BLF list, flash, Extensible Markup Language (XML), flash, sprecode, park, pickup, Last Call Return (lcr), Directory, Callers List, Conference, and Transfer.) You can configure up to 20 functions.
- **Programmable Keys** - Allows you to configure up to 6 top programmable keys for a specific function (none, line, speedial, do not disturb (DND), Busy Lamp Field (BLF), BLF list, flash, Extensible Markup Language (XML), flash, sprecode, park, pickup, Last Call Return (lcr), Directory, Callers List, Conference, and Transfer.) You can configure up to 6 functions. By default, keys 1 through 4 are configured as Services, Directory, Callers List, and Intercom, respectively. You can configure up to 6 functions on the top programmable keys.

Directory - Allows you to copy the Callers List and Directory List from your IP phone to your PC.

- **Reset** - Allows you to restart the IP phone when required.
- **Expansion Modules** - Allows you to configure an additional 36 softkeys (with 536EM) if an expansion module is attached to the phone. If no expansion module is attached, the following message displays: **"No expansion modules are currently attached"**.

Basic Settings

The **Basic Settings** section provides the following options:

- **Preferences** - Allows you to enable/disable the following: static configuration of park/pickup, suppression of DTMF playback, display of DTMF digits, the playing of call waiting tone, and stuttered dial tone. This category also allows you to configure incoming intercom call settings, ring tones (global and per-line basis), and ring tone sets, time and date settings, and language settings.
- **Call Forward** - Allows you to set a phone number destination for where you want calls forwarded. Call forward can be configured using a specific mode (off, all, busy, no answer, busy no answer) on a global or per-line basis.

User Password





This category allows you to change the user password for your phone. Changing your password ensures that only you can alter your phone settings, and helps keep your system secure. You can change your user password using the IP Phone UI or the Aastra Web UI.

If you change the password	you will need to:
using the IP Phone UI,	use that new password to log into the Aastra Web UI.
using the Aastra Web UI,	use that new password when changing the user password via the IP Phone UI.

Note: Valid values when creating or changing a password are 0 to 4294967295 (integers only; symbols and alpha characters are not allowed). Default password is an empty string "" (field is blank).



IP Phone UI

1. Press  on the phone to enter the Options List.
2. Select **User Password** and press  .
3. Enter the current user password and press  .
4. Enter the new user password and press  .
5. Re-enter the new user password and press  .
A message, "Password Changed" displays on the screen.



Aastra Web UI

1. Click on **Operation->User Password**.

Status System Information Operation User Password Phone Lock Softkeys and XML Programmable Keys Directory Reset Basic Settings Preferences Call Forward	<h3>Reset User Password</h3> <p>Please enter the current and new passwords</p> <p>Current Password <input type="text"/></p> <p>New Password <input type="text"/></p> <p>Password Confirm <input type="text"/></p> <p><input type="button" value="Save Settings"/></p>
---	--

2. In the "**Current Password**" field, enter the current user password.

Note: By default, the user name is "user" (all lowercase) and the password field is left blank.

3. In the "**New Password**" field, enter the new user password.

4. In the "**Password Confirm**" field, enter the new user password again.

5. Click  to save your changes.



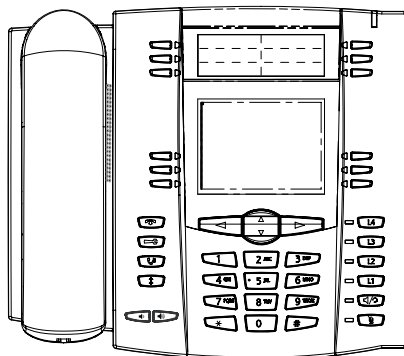

Using Your Phone





The following sections describe the various 55i phone key functions, and how they help you make and manage your calls and caller information.





Key Descriptions

The following table identifies the keys on the key panel of your 55i IP phone that you can use for handling calls.

Keys	Key Description
	Goodbye key - Ends an active call. The Goodbye key also exits an open list, such as the Options List, without saving changes.
	Options key - Accesses options to customize your phone. Your System Administrator may have already customized some of your settings. Check with your System Administrator before changing the administrator-only options.
	Hold key - Places an active call on hold. To retrieve a held call, press the call appearance button beside the light that is flashing.
	Redial key - Redials up to 100 previously dialed numbers. Pressing the Redial key twice simultaneously redials the last dialed number.
	Volume control key - Adjusts the volume for the handset, headset, ringer, and handsfree speaker.

Keys	Key Description
	<p>Line/Call Appearance key - Connects you to a line or call. The Aastra 55i IP phone supports up to 4 line keys.</p>
	<p>Handsfree key - Activates Handsfree for making and receiving calls without lifting the handset. When the audio mode option is set, this key is used to switch between a headset and the handsfree speakerphone.</p>
	<p>Mute key - Mutes the microphone so that your caller cannot hear you (the light indicator flashes when the microphone is on mute).</p>
	<p>Navigation keys - Pressing the UP and DOWN arrow keys lets you view different status and text messages on the LCD display (if there is more than 1 line of status/text messages). These buttons also let you scroll through menu selections, such as the Options List.</p> <p>Pressing the LEFT and RIGHT arrow keys lets you view the different line/call appearances. While in the Options List, these keys allow you to exit or enter the current option. When you are editing entries on the display, pressing the LEFT arrow key erases the character on the left; pressing the RIGHT arrow key sets the option.</p>

Keys	Key Description
	<p>Programmable keys - 6 Top keys: programmable hard keys (up to 6 programmable functions)</p> <p>By default, keys 1 through 4 are assigned as Services, Directory, Callers List, and Intercom, respectively. Keys 5 and 6 have no assigned functions. All 6 keys are programmable and can be assigned to perform specific functions.</p> <p>The following are the default functions for the programmable keys on the 55i IP phone:</p> <ul style="list-style-type: none"> 1 - SERVICES Accesses enhanced features and services such as XML applications and voicemail, provided by third parties. 2 - DIRECTORY Displays up to 200 names and phone numbers (stored in alphabetical order) 3 - CALLERS LIST Accesses the last 200 calls received. 4 - INTERCOM Accesses another extension on the network. 5 - NONE No assigned function 6 - NONE No assigned function
	<p>Softkeys - 6 Bottom keys: programmable state-based softkeys (up to 20 programmable functions).</p>

Multiple Line and Call Appearances

The 55i has 4 hard line/call appearance buttons each with a corresponding status light. These line/call appearance buttons and lights can represent physical lines, calls for your extension or calls from a group that your extension is part of. By pressing a line/call appearance button, you connect to the line or a call it represents. The line/call appearance light indicates the status of that line or call. When the phone is taken off-hook, the phone automatically selects a line for you.

Line/Call Appearance Light Behavior	Line/Call Appearance Status
Off	Idle line or no call activity
Light flashes quickly	Ringing
Light is solid	Connected
Light flashes slowly	Hold

When you have more than one call, you can use the left and right navigation buttons (◀ and ▶) to scroll left and right to the different call information. Icons ◀ and ▶ will appear if there is call information either left, right or both sides of the current information you are viewing.

The display shows which line the call information is referring to (L1, L2, L3, etc.), the Caller ID information (name and number, if available), the call status (Connected, Ring, Hold etc.) and the timer specific to that call.

Softkeys and Programmable Keys

Your 55i has 6 multi-functional top programmable keys and 6 multi-functional bottom softkeys:

- **6 Top Keys:** programmable hard keys (up to 6 programmable functions)
- **6 Bottom Keys:** programmable state-based softkeys (up to 20 programmable functions).

Note: If 536 Expansion Module(s) are attached to the phone, click on **Operation->Expansion Keys** to access and configure up to 36 softkeys on each Expansion Module (Phone allows up to 3 expansion modules totaling up to 108 additional softkeys). These keys allow you to configure BLF, Speeddial, and Shared Call Appearance functions only. For more information about expansion modules, see "[Model 536 Expansion Modules \(536EM\)](#)" on [page 131](#).

You can program these keys for call handling and extension management of the SIP system. The keys on the menus of the IP phone UI change depending on the phone's state, displaying relevant softkeys only.

Note: The softkey functions outlined in this section represent the default arrangement of softkeys on the 55i IP phone. Only the bottom softkeys are state-based.

The 55i default top and bottom keys are shown in the following illustration.

Top Programmable Keys

Key	Type	Value	Line
1	Services		global
2	Directory		1
3	Callers List		1
4	Intercom		global
5	None		1
6	None		1

Services
BLF List URI:

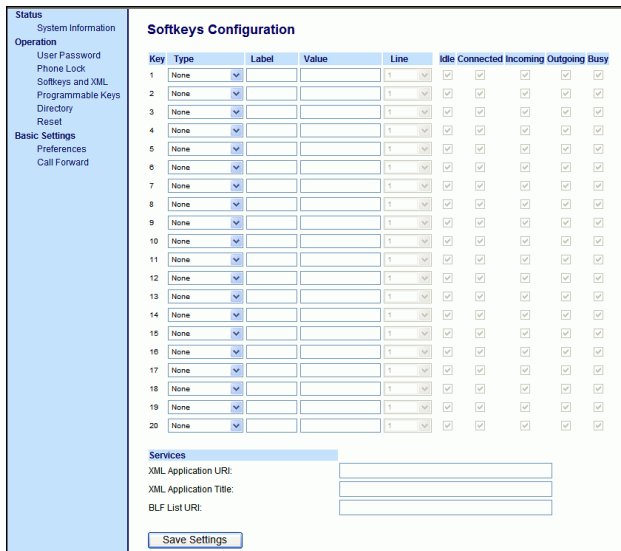

Softkey Functions

You can configure the 55i softkeys for any of the following:

Softkey Function	Description
None	Indicates softkey is disabled (option for Web UI only)
Line	Indicates softkey is configured for line use.
Speedial	Indicates softkey is configured for speedial use. Available on 536EM also.
Do Not Disturb (DND)	Indicates softkey is configured for "do not disturb" use.
BLF	Indicates softkey is configured for Busy Lamp Field (BLF) use. A user can dial out on a BLF configured softkey. Available on 536EM also.
BLF\List	Indicates softkey is configured for BLF list use. A user can dial out on a BLF\List configured softkey.
XML	Indicates the softkey is configured to accept an XML application for accessing customized XML services. You can also use this option to configure an XML URI softkey.

Flash	Indicates the softkey is set to generate a flash event when it is pressed. The IP phone generates flash events only when a call is connected and there is an active RTP stream (for example, when the call is not on hold.)
Sprecode	Indicates the softkey is set to automatically activate specific services offered by the server. For example, if the spre value of *82 is configured, then by pressing the softkey, *82 automatically activates a service provided by the server. The value you enter for this field is dependent on the services provided by the server.
Park	Indicates the softkey is set to be used as a park key to park an incoming call.
Pickup	Indicates the softkey is set to be used as a pickup key to pick up a parked call.
Last Call Return (lcr)	Indicates the softkey is set to be used as a "last call return" key.
Services	Indicates the softkey is set to be used as the Services key.
Callers List	Indicates the softkey is set for accessing the Callers List.
Directory	Indicates the softkey is set for accessing the Directory List.
Intercom	Indicates the softkey is set to be used as the Intercom key.
Empty	Indicates the softkey is configured to force a blank entry on the IP phone display for a specific softkey. The soft keys are added in order (from softkey1 to softkey20) after any hard-coded keys have been added. If a particular soft key is not defined, it is ignored.

State-Based Softkeys (Bottom Keys only)

On the 55i bottom softkeys, you can configure a specific state to display when a softkey is being used. Available states you can configure for each softkey include:

- **idle** - The phone is not being used.
- **connected** - The current line is in an active call (or the call is on hold)
- **incoming** - The phone is ringing.
- **outgoing** - The user is dialing a number, or the far-end is ringing.
- **busy** - The current line is busy because the line is in use or the line is set as "Do Not Disturb".

The following table identifies the applicable default states for each softkeys type on the IP phone.

Softkey Type	Default States
None	All states disabled.
Line	idle, connected, incoming, outgoing, busy
DND	idle, connected, incoming, outgoing, busy
Speeddial	idle, connected, incoming, outgoing, busy
BLF	idle, connected, incoming, outgoing, busy
BLF List	idle, connected, incoming, outgoing, busy
XML	idle, connected, incoming, outgoing, busy
Icr	idle, connected, incoming, outgoing, busy
Directory	idle, connected, incoming, outgoing, busy
Callers List	idle, connected, incoming, outgoing, busy
Intercom	idle, connected, incoming, outgoing, busy
Services	idle, connected, incoming, outgoing, busy
empty	idle, connected, incoming, outgoing, busy
Flash	All states disabled.
Sprecode	connected
Park	connected
Pickup	idle, outgoing

In the Aastra Web UI, the operational states for each softkey display enabled. To disable a state, you uncheck the box for that operational state.

The IP phone idle screen condenses the softkeys. For example, if you set softkey 12 as the following:

Type: speeddial

Label: Voicemail

Value *89

State: outgoing

then softkey 12 appears in position 1 if no other softkeys are set. A softkey type of "empty" does not display on the idle screen at all.

Softkeys as Line/Call Appearances

You can customize the softkeys on your 55i phone to function as line/call appearance softkeys. These line/call appearance softkeys function in a similar manner to the 4 line/call appearance hard keys and lights on your phone. For details on the line/call appearance hard keys and lights, please refer to the section "[Multiple Line and Call Appearances](#)" on page 23 of this manual.

Lines/call appearance softkeys appear on the phone's display as shown in the following image.

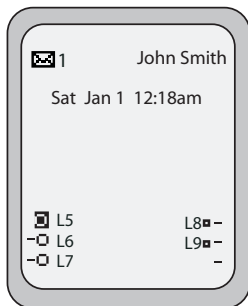





Icons next to the softkeys within the phone's display indicate the status for that line or call and have equivalent status to the line/call appearance lights of the hard keys on the phone. The following table provides a description for each icon.

Softkey Line/Call Appearance Lights			
Activity	Light	Icon	Definition
Idle	Solid	■	There is no call activity for the line/call appearance softkey.
Connected	Solid	□	A call is connected to your phone on this line/call appearance softkey. The equivalent on a line/call appearance hard key is a solid green light.
Ringing	Flashing	◻	A call is ringing at your phone on this line/call appearance softkey. The equivalent on a line/call appearance hard key is a fast flashing green light.
On Hold	Flashing	◻	A call is on hold on your phone on this line/call appearance softkey. The equivalent on a line/call appearance hard key is a slow flashing green light.

Depending on how the phone has been configured, the maximum number of total line/call appearances that can be set up is 8 or 9 (4 line/call appearance as hard keys and 4 or 5 as softkeys). If all line/call appearances have been set up for the same number, a total of 9 lines can be configured. If all line/call appearances have been set up between two different numbers, a total of 8 lines can be configured. This means that when all line/call appearances are in use, 1 call is connected while the rest are on hold. No further outgoing or incoming calls can be made until one of the line/call appearances becomes available.

In active states, such as ringing, conference, connected, etc., all softkeys disappear except softkeys that have been set up as line/call appearances, and any context dependent softkeys required for the active state, such as the **Drop** softkey in the connected state. Typically, context dependent softkeys appear in the top left position and all line/call appearance softkeys appear in the remaining positions.

Note: In some situations, such as during a conference call, the line/call appearance softkeys may overwrite some of the context dependent soft keys. In this case, instead of the **Previous** and **Next** softkeys, up or down icons,   appear on the display. By using the   navigation keys, you can access the same functionality as the **Previous** and **Next** softkeys.

Setting a Line Softkey or Programmable Key

You can set a softkey or programmable key as an additional line on the 55i. The key acts as a line that behaves the same as a hard line key. For more information about the behavior of line keys, see "[Multiple Line and Call Appearances](#)" on page 23.

You can use the Aastra Web UI only to set a softkey or programmable key as a line. On the 55i, you can set the top programmable keys with up to 6 functions and the bottom softkeys with up to 20 functions.



Aastra Web UI

Use the following procedure to set a softkey to function as a line.

1. Click on **Operation->Softkeys and XML.**
or
Click on **Operation->Programmable Keys.**

Status

System Information

Operation

User Password

Phone Lock

Softkeys and XML

Programmable Keys

Directory

Reset

Basic Settings

Preferences

Call Forward

Softkeys Configuration

Key	Type	Label	Value	Line	Idle	Connected	Incoming	Outgoing	Busy
1	Line	L1		5	<input checked="" type="checkbox"/>	<input checked="" type="checkbox"/>	<input checked="" type="checkbox"/>	<input checked="" type="checkbox"/>	<input checked="" type="checkbox"/>
2	Speeddial	Home	5555555	1	<input checked="" type="checkbox"/>	<input checked="" type="checkbox"/>	<input checked="" type="checkbox"/>	<input checked="" type="checkbox"/>	<input checked="" type="checkbox"/>
3	Do Not Disturb			1	<input checked="" type="checkbox"/>	<input checked="" type="checkbox"/>	<input checked="" type="checkbox"/>	<input checked="" type="checkbox"/>	<input checked="" type="checkbox"/>
4	BLF	BLF	3333333	1	<input checked="" type="checkbox"/>	<input checked="" type="checkbox"/>	<input checked="" type="checkbox"/>	<input checked="" type="checkbox"/>	<input checked="" type="checkbox"/>
5	BLF/List			1	<input checked="" type="checkbox"/>	<input checked="" type="checkbox"/>	<input checked="" type="checkbox"/>	<input checked="" type="checkbox"/>	<input checked="" type="checkbox"/>
6	XML	Stocks	http://stocks.com	1	<input checked="" type="checkbox"/>	<input checked="" type="checkbox"/>	<input checked="" type="checkbox"/>	<input checked="" type="checkbox"/>	<input checked="" type="checkbox"/>
7	Flash	Flash		1	<input checked="" type="checkbox"/>	<input checked="" type="checkbox"/>	<input checked="" type="checkbox"/>	<input checked="" type="checkbox"/>	<input checked="" type="checkbox"/>
8	Sprecode	Sprecode	*90	1	<input checked="" type="checkbox"/>	<input checked="" type="checkbox"/>	<input checked="" type="checkbox"/>	<input checked="" type="checkbox"/>	<input checked="" type="checkbox"/>
9	Park	John	*700	1	<input checked="" type="checkbox"/>	<input checked="" type="checkbox"/>	<input checked="" type="checkbox"/>	<input checked="" type="checkbox"/>	<input checked="" type="checkbox"/>
10	Pickup	James	*700	1	<input checked="" type="checkbox"/>	<input checked="" type="checkbox"/>	<input checked="" type="checkbox"/>	<input checked="" type="checkbox"/>	<input checked="" type="checkbox"/>
11	Last Call Return			1	<input checked="" type="checkbox"/>	<input checked="" type="checkbox"/>	<input checked="" type="checkbox"/>	<input checked="" type="checkbox"/>	<input checked="" type="checkbox"/>
12	Directory	Dir		1	<input checked="" type="checkbox"/>	<input checked="" type="checkbox"/>	<input checked="" type="checkbox"/>	<input checked="" type="checkbox"/>	<input checked="" type="checkbox"/>
13	Callers List	Callers List		1	<input checked="" type="checkbox"/>	<input checked="" type="checkbox"/>	<input checked="" type="checkbox"/>	<input checked="" type="checkbox"/>	<input checked="" type="checkbox"/>
14	Intercom	Icom		1	<input checked="" type="checkbox"/>	<input checked="" type="checkbox"/>	<input checked="" type="checkbox"/>	<input checked="" type="checkbox"/>	<input checked="" type="checkbox"/>
15	Services	Services		1	<input checked="" type="checkbox"/>	<input checked="" type="checkbox"/>	<input checked="" type="checkbox"/>	<input checked="" type="checkbox"/>	<input checked="" type="checkbox"/>
16	Empty			1	<input checked="" type="checkbox"/>	<input checked="" type="checkbox"/>	<input checked="" type="checkbox"/>	<input checked="" type="checkbox"/>	<input checked="" type="checkbox"/>
17	None			1	<input checked="" type="checkbox"/>	<input checked="" type="checkbox"/>	<input checked="" type="checkbox"/>	<input checked="" type="checkbox"/>	<input checked="" type="checkbox"/>
18	None			1	<input checked="" type="checkbox"/>	<input checked="" type="checkbox"/>	<input checked="" type="checkbox"/>	<input checked="" type="checkbox"/>	<input checked="" type="checkbox"/>
19	None			1	<input checked="" type="checkbox"/>	<input checked="" type="checkbox"/>	<input checked="" type="checkbox"/>	<input checked="" type="checkbox"/>	<input checked="" type="checkbox"/>
20	None			1	<input checked="" type="checkbox"/>	<input checked="" type="checkbox"/>	<input checked="" type="checkbox"/>	<input checked="" type="checkbox"/>	<input checked="" type="checkbox"/>

Services

XML Application URI:

XML Application Title:

BLF List URI:

Key	Type	Value	Line
1	Services		global
2	Directory		1
3	Callers List		1
4	Intercom		global
5	None		1
6	None		1

Services

BLF List URI:

2. For softkeys, select from "**Key 1**" through "**Key 20**".
or
For programmable keys, select from "**Key 1**" through "**Key 6**".
3. In the "**Type**" field, select **Line** to apply to the softkey or programmable key.
4. In the "**Label**" field, enter a label to apply to this softkey.
5. In the "**Line**" field, select a line to apply to this softkey.
Valid values are 5 through 9.
6. If configuring a softkey, in the state fields, check (enable) or uncheck (disable) the states you want to apply to this softkey.
7. Click to save your changes.
8. Click on **Operation->Reset**.
9. In the "**Restart Phone**" field click to restart the IP phone.

Softkeys as Speeddials

You can set up custom softkeys as speeddials. Speeddial softkeys can dial a star code for a feature on the system or a phone number or a set of digits. A customized label displays inside the phone's display for each softkey. If you press a custom softkey, the phone goes off-hook and dials the star code or the number set up for this softkey.

Setting a Speeddial Softkey

The speeddial function can be set using the IP Phone UI or the Aastra Web UI.

You can save up to 30 speed dial numbers and names on the 55i. These can be programmed to dial directly to another person's line or extension, or set up to quickly access features such as Caller ID (*69), Voicemail.

Use the following procedures to set speeddial on the 55i IP phone.

Entering a Name/Number for Speeddial Key



IP Phone UI

To enter a number and name in a programmable key:

1. Press the **Save** key. The screen displays "**Save to?**"

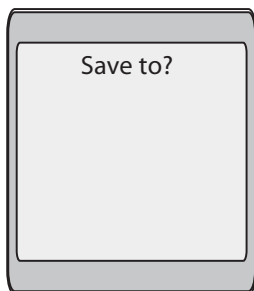

2. Select a softkey you want to save to.
3. At the "**Enter Number**" prompt, use the dial pad key to enter the number.

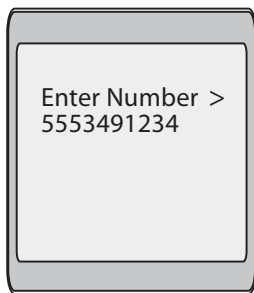

4. Press the **Save** key to save the speeddial configuration.

5. At the "**Enter Name**" prompt, use the dial pad keys to select the letters. Continue to press the number key to access the next letter for that key (i.e. press **2** three times to access **C**). Press **▶** to move to the next space, or wait a moment and the cursor automatically advances. To insert a space between letters, press **▶** . To backspace and erase a mistake, press **◀** or the **Delete** key. You can save up to 16 letters and numbers on each softkey entry.

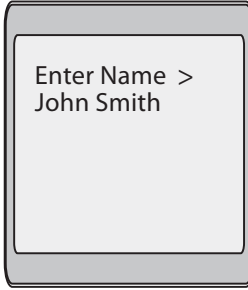

6. Press the **Save** key to finish.



On the 55i, you can set the top softkeys with up to 6 speeddials and the bottom softkeys with up to 20 speeddials.

1. Click on **Operation->Softkeys and XML**.

or

Click on **Operation->Programmable Keys**.

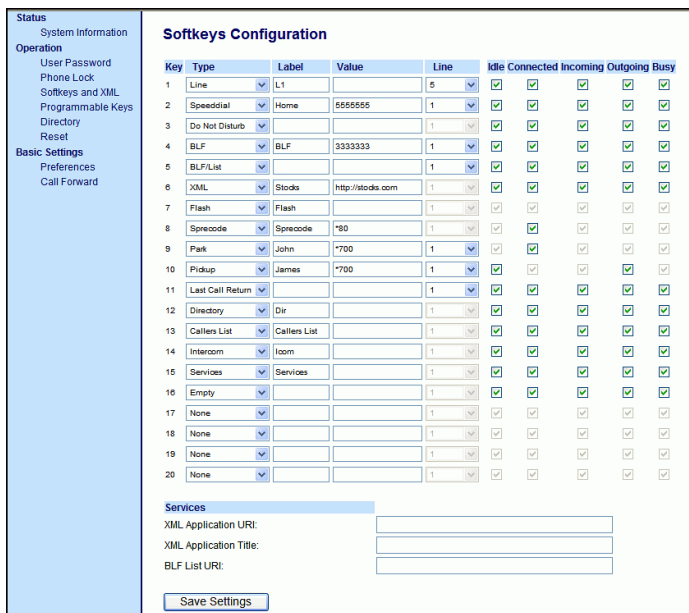

Key	Type	Label	Value	Line	Idle	Connected	Incoming	Outgoing	Busy
1	Line	L1		5	<input checked="" type="checkbox"/>	<input checked="" type="checkbox"/>	<input checked="" type="checkbox"/>	<input checked="" type="checkbox"/>	<input checked="" type="checkbox"/>
2	Speeddial	Home	5555555	1	<input checked="" type="checkbox"/>	<input checked="" type="checkbox"/>	<input checked="" type="checkbox"/>	<input checked="" type="checkbox"/>	<input checked="" type="checkbox"/>
3	Do Not Disturb			1	<input checked="" type="checkbox"/>	<input checked="" type="checkbox"/>	<input checked="" type="checkbox"/>	<input checked="" type="checkbox"/>	<input checked="" type="checkbox"/>
4	BLF	BLF	3333333	1	<input checked="" type="checkbox"/>	<input checked="" type="checkbox"/>	<input checked="" type="checkbox"/>	<input checked="" type="checkbox"/>	<input checked="" type="checkbox"/>
5	BLF/List			1	<input checked="" type="checkbox"/>	<input checked="" type="checkbox"/>	<input checked="" type="checkbox"/>	<input checked="" type="checkbox"/>	<input checked="" type="checkbox"/>
6	XML	Stocks	http://stocks.com	1	<input checked="" type="checkbox"/>	<input checked="" type="checkbox"/>	<input checked="" type="checkbox"/>	<input checked="" type="checkbox"/>	<input checked="" type="checkbox"/>
7	Flash	Flash		1	<input checked="" type="checkbox"/>	<input checked="" type="checkbox"/>	<input checked="" type="checkbox"/>	<input checked="" type="checkbox"/>	<input checked="" type="checkbox"/>
8	Sperecode	Sperecode	*80	1	<input checked="" type="checkbox"/>	<input checked="" type="checkbox"/>	<input checked="" type="checkbox"/>	<input checked="" type="checkbox"/>	<input checked="" type="checkbox"/>
9	Park	John	*700	1	<input checked="" type="checkbox"/>	<input checked="" type="checkbox"/>	<input checked="" type="checkbox"/>	<input checked="" type="checkbox"/>	<input checked="" type="checkbox"/>
10	Pickup	James	*700	1	<input checked="" type="checkbox"/>	<input checked="" type="checkbox"/>	<input checked="" type="checkbox"/>	<input checked="" type="checkbox"/>	<input checked="" type="checkbox"/>
11	Last Call Return			1	<input checked="" type="checkbox"/>	<input checked="" type="checkbox"/>	<input checked="" type="checkbox"/>	<input checked="" type="checkbox"/>	<input checked="" type="checkbox"/>
12	Directory	Dir		1	<input checked="" type="checkbox"/>	<input checked="" type="checkbox"/>	<input checked="" type="checkbox"/>	<input checked="" type="checkbox"/>	<input checked="" type="checkbox"/>
13	Callers List	Callers List		1	<input checked="" type="checkbox"/>	<input checked="" type="checkbox"/>	<input checked="" type="checkbox"/>	<input checked="" type="checkbox"/>	<input checked="" type="checkbox"/>
14	Intercom	loom		1	<input checked="" type="checkbox"/>	<input checked="" type="checkbox"/>	<input checked="" type="checkbox"/>	<input checked="" type="checkbox"/>	<input checked="" type="checkbox"/>
15	Services	Services		1	<input checked="" type="checkbox"/>	<input checked="" type="checkbox"/>	<input checked="" type="checkbox"/>	<input checked="" type="checkbox"/>	<input checked="" type="checkbox"/>
16	Empty			1	<input checked="" type="checkbox"/>	<input checked="" type="checkbox"/>	<input checked="" type="checkbox"/>	<input checked="" type="checkbox"/>	<input checked="" type="checkbox"/>
17	None			1	<input checked="" type="checkbox"/>	<input checked="" type="checkbox"/>	<input checked="" type="checkbox"/>	<input checked="" type="checkbox"/>	<input checked="" type="checkbox"/>
18	None			1	<input checked="" type="checkbox"/>	<input checked="" type="checkbox"/>	<input checked="" type="checkbox"/>	<input checked="" type="checkbox"/>	<input checked="" type="checkbox"/>
19	None			1	<input checked="" type="checkbox"/>	<input checked="" type="checkbox"/>	<input checked="" type="checkbox"/>	<input checked="" type="checkbox"/>	<input checked="" type="checkbox"/>
20	None			1	<input checked="" type="checkbox"/>	<input checked="" type="checkbox"/>	<input checked="" type="checkbox"/>	<input checked="" type="checkbox"/>	<input checked="" type="checkbox"/>

Services

XML Application URI:

XML Application Title:

BLF List URI:

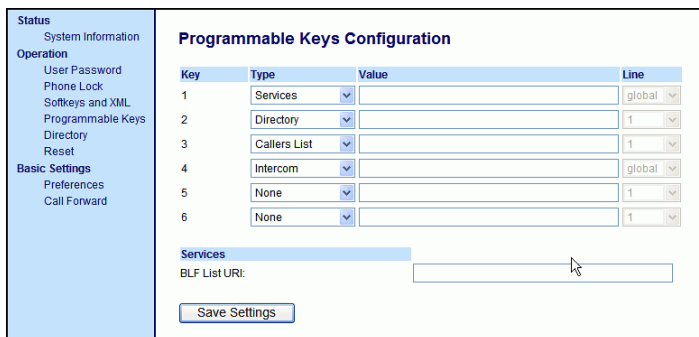

Key	Type	Value	Line
1	Services		global
2	Directory		1
3	Callers List		1
4	Intercom		global
5	None		1
6	None		1

Services

BLF List URI:

2. For softkeys, select from **"Key 1"** through **"Key 20"**.

or

For programmable keys, select from **"Key 1"** through **"Key 6"**.

3. In the "**Type**" field, select **Speeddial** to apply to the softkey.
4. In the "**Label**" field, enter a label to apply to this softkey.
5. In the "**Value**" field, enter the phone number or extension to apply to this softkey.
6. In the "**Line**" field, select a line to apply to this softkey.
Valid values are 1 through 9.
7. If configuring a softkey on the Bottom Keys, in the state fields, check (enable) or uncheck (disable) the states you want to apply to this softkey.
8. Click to save your changes.
9. Click on **Operation->Reset**.
10. In the "**Restart Phone**" field click to restart the IP phone.

Saving an Entry from the Redial, Callers, or Directory Lists to a Speedial key



IP Phone UI

Use the following procedure to save an entry from your Directory List, Callers List, or Redial List on the IP phone.

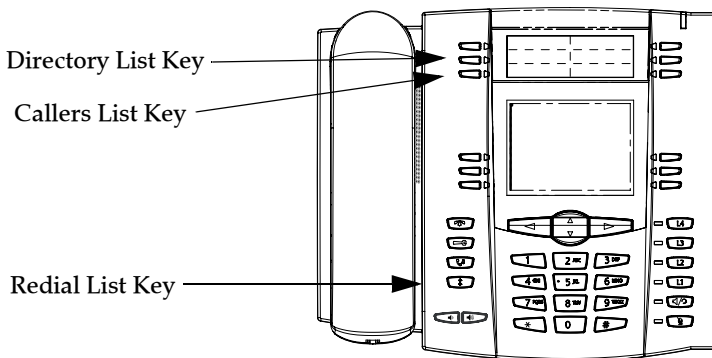

1. Press the Directory List, Callers List, or Redial List key. From the Callers List or Redial List, scroll through the list to find the name and number that you wish to save to your speed dial.
2. Press the **Save** key.
3. Press the selected speed dial. If the name is displayed with the number, both are saved to the speed dial. If no name is displayed, you can enter the name using the dial pad.

Softkeys as "Do not Disturb"

The IP phones have a feature you can enable called "Do not Disturb (DND)". The DND function allows you to turn "do not disturb" ON and OFF.

Note: You can configure DND using the Aastra Web UI only.

If DND is ON, callers calling into the phone hear a busy signal or a message, depending on how your system administrator set up the configuration server. The second line on the screen of the IP phone shows when DND is set.

If the phone shares a line with other phones, only the phone that has DND configured is affected.

You can set DND on the softkeys using the Aastra Web UI only. DND is not configurable from the IP phone UI.

Setting a "Do Not Disturb" Softkey



Aastra Web UI

1. Click on **Operation->Softkeys and XML.**

or

Click on **Operation->Programmable Keys.**

Key	Type	Label	Value	Line	Idle	Connected	Incoming	Outgoing	Busy
1	Line	L1		5	<input checked="" type="checkbox"/>	<input checked="" type="checkbox"/>	<input checked="" type="checkbox"/>	<input checked="" type="checkbox"/>	<input checked="" type="checkbox"/>
2	Speeddial	Home	5555555	1	<input checked="" type="checkbox"/>	<input checked="" type="checkbox"/>	<input checked="" type="checkbox"/>	<input checked="" type="checkbox"/>	<input checked="" type="checkbox"/>
3	Do Not Disturb			1	<input checked="" type="checkbox"/>	<input checked="" type="checkbox"/>	<input checked="" type="checkbox"/>	<input checked="" type="checkbox"/>	<input checked="" type="checkbox"/>
4	BLF	BLF	3333333	1	<input checked="" type="checkbox"/>	<input checked="" type="checkbox"/>	<input checked="" type="checkbox"/>	<input checked="" type="checkbox"/>	<input checked="" type="checkbox"/>
5	BLF>List			1	<input checked="" type="checkbox"/>	<input checked="" type="checkbox"/>	<input checked="" type="checkbox"/>	<input checked="" type="checkbox"/>	<input checked="" type="checkbox"/>
6	XML	Stods	http://stods.com	1	<input checked="" type="checkbox"/>	<input checked="" type="checkbox"/>	<input checked="" type="checkbox"/>	<input checked="" type="checkbox"/>	<input checked="" type="checkbox"/>
7	Flash	Flash		1	<input checked="" type="checkbox"/>	<input checked="" type="checkbox"/>	<input checked="" type="checkbox"/>	<input checked="" type="checkbox"/>	<input checked="" type="checkbox"/>
8	Spreecode	Spreecode	*80	1	<input checked="" type="checkbox"/>	<input checked="" type="checkbox"/>	<input checked="" type="checkbox"/>	<input checked="" type="checkbox"/>	<input checked="" type="checkbox"/>
9	Park	John	*700	1	<input checked="" type="checkbox"/>	<input checked="" type="checkbox"/>	<input checked="" type="checkbox"/>	<input checked="" type="checkbox"/>	<input checked="" type="checkbox"/>
10	Pickup	James	*700	1	<input checked="" type="checkbox"/>	<input checked="" type="checkbox"/>	<input checked="" type="checkbox"/>	<input checked="" type="checkbox"/>	<input checked="" type="checkbox"/>
11	Last Call Return			1	<input checked="" type="checkbox"/>	<input checked="" type="checkbox"/>	<input checked="" type="checkbox"/>	<input checked="" type="checkbox"/>	<input checked="" type="checkbox"/>
12	Directory	Dir		1	<input checked="" type="checkbox"/>	<input checked="" type="checkbox"/>	<input checked="" type="checkbox"/>	<input checked="" type="checkbox"/>	<input checked="" type="checkbox"/>
13	Callers List	Callers List		1	<input checked="" type="checkbox"/>	<input checked="" type="checkbox"/>	<input checked="" type="checkbox"/>	<input checked="" type="checkbox"/>	<input checked="" type="checkbox"/>
14	Intercom	loomp		1	<input checked="" type="checkbox"/>	<input checked="" type="checkbox"/>	<input checked="" type="checkbox"/>	<input checked="" type="checkbox"/>	<input checked="" type="checkbox"/>
15	Services	Services		1	<input checked="" type="checkbox"/>	<input checked="" type="checkbox"/>	<input checked="" type="checkbox"/>	<input checked="" type="checkbox"/>	<input checked="" type="checkbox"/>
16	Empty			1	<input checked="" type="checkbox"/>	<input checked="" type="checkbox"/>	<input checked="" type="checkbox"/>	<input checked="" type="checkbox"/>	<input checked="" type="checkbox"/>
17	None			1	<input checked="" type="checkbox"/>	<input checked="" type="checkbox"/>	<input checked="" type="checkbox"/>	<input checked="" type="checkbox"/>	<input checked="" type="checkbox"/>
18	None			1	<input checked="" type="checkbox"/>	<input checked="" type="checkbox"/>	<input checked="" type="checkbox"/>	<input checked="" type="checkbox"/>	<input checked="" type="checkbox"/>
19	None			1	<input checked="" type="checkbox"/>	<input checked="" type="checkbox"/>	<input checked="" type="checkbox"/>	<input checked="" type="checkbox"/>	<input checked="" type="checkbox"/>
20	None			1	<input checked="" type="checkbox"/>	<input checked="" type="checkbox"/>	<input checked="" type="checkbox"/>	<input checked="" type="checkbox"/>	<input checked="" type="checkbox"/>

Services

XML Application URI:

XML Application Title:

BLF List URI:

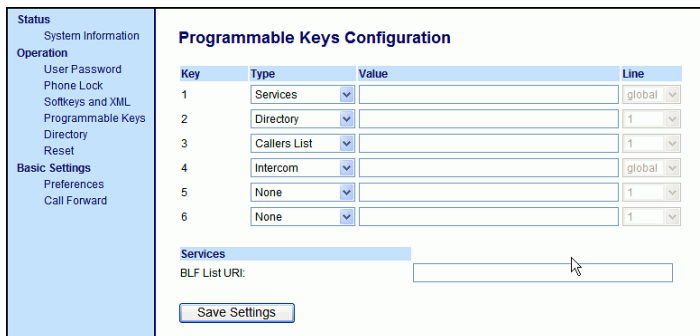

- For softkeys, select from "**Key 1**" through "**Key 20**".
or
For programmable keys, select from "**Key 1**" through "**Key 6**".
- In the "**Type**" field, select **Do Not Disturb** to apply to the softkey.
- If configuring a softkey on the Bottom Keys, in the state fields, check (enable) or uncheck (disable) the states you want to apply to this softkey.
- Click to save your changes.
- Click on **Operation->Reset**.
- In the "**Restart Phone**" field click to restart the IP phone.

Softkeys as Busy Lamp Field (BLF)

You can set a softkey to Busy Lamp Field (BLF).

The BLF feature on the IP phones allows a specific extension to be monitored for state changes. BLF monitors the status (busy or idle) of extensions on the IP phone.

Note: The BLF setting is applicable to the Asterisk server only.

Example

A Supervisor configures BLFs on his phone for monitoring the status of a worker's phone use (busy or idle). When the worker picks up his phone to make a call, a busy indicator on the Supervisor's phone shows that the worker's phone is in use and busy.

On the 55i, the busy and idle indicators show on the IP phone screen display next to the softkey programmed for BLF functionality. When the monitored user is idle, an icon with the handset on-hook shows next to the BLF softkey. When the monitored user is on an active call, a small telephone icon is shown with the handset off-hook.

Note: You can also use the BLF configured softkey to dial out. Contact your system administrator for more information.

Setting a BLF Softkey



Aastra Web UI

1. Click on **Operation->Softkeys and XML.**

or

Click on **Operation->Programmable Keys.**

Key	Type	Label	Value	Line	Idle	Connected	Incoming	Outgoing	Busy
1	Line	L1		5	<input checked="" type="checkbox"/>	<input checked="" type="checkbox"/>	<input checked="" type="checkbox"/>	<input checked="" type="checkbox"/>	<input checked="" type="checkbox"/>
2	Speeddial	Home	5555555	1	<input checked="" type="checkbox"/>	<input checked="" type="checkbox"/>	<input checked="" type="checkbox"/>	<input checked="" type="checkbox"/>	<input checked="" type="checkbox"/>
3	Do Not Disturb			1	<input checked="" type="checkbox"/>	<input checked="" type="checkbox"/>	<input checked="" type="checkbox"/>	<input checked="" type="checkbox"/>	<input checked="" type="checkbox"/>
4	BLF	BLF	3333333	1	<input checked="" type="checkbox"/>	<input checked="" type="checkbox"/>	<input checked="" type="checkbox"/>	<input checked="" type="checkbox"/>	<input checked="" type="checkbox"/>
5	BLF/List			1	<input checked="" type="checkbox"/>	<input checked="" type="checkbox"/>	<input checked="" type="checkbox"/>	<input checked="" type="checkbox"/>	<input checked="" type="checkbox"/>
6	XML	Stoda	http://stoda.com	1	<input checked="" type="checkbox"/>	<input checked="" type="checkbox"/>	<input checked="" type="checkbox"/>	<input checked="" type="checkbox"/>	<input checked="" type="checkbox"/>
7	Flash	Flash		1	<input checked="" type="checkbox"/>	<input checked="" type="checkbox"/>	<input checked="" type="checkbox"/>	<input checked="" type="checkbox"/>	<input checked="" type="checkbox"/>
8	Spreecode	Spreecode	*80	1	<input checked="" type="checkbox"/>	<input checked="" type="checkbox"/>	<input checked="" type="checkbox"/>	<input checked="" type="checkbox"/>	<input checked="" type="checkbox"/>
9	Park	John	*700	1	<input checked="" type="checkbox"/>	<input checked="" type="checkbox"/>	<input checked="" type="checkbox"/>	<input checked="" type="checkbox"/>	<input checked="" type="checkbox"/>
10	Pickup	James	*700	1	<input checked="" type="checkbox"/>	<input checked="" type="checkbox"/>	<input checked="" type="checkbox"/>	<input checked="" type="checkbox"/>	<input checked="" type="checkbox"/>
11	Last Call Return			1	<input checked="" type="checkbox"/>	<input checked="" type="checkbox"/>	<input checked="" type="checkbox"/>	<input checked="" type="checkbox"/>	<input checked="" type="checkbox"/>
12	Directory	Dir		1	<input checked="" type="checkbox"/>	<input checked="" type="checkbox"/>	<input checked="" type="checkbox"/>	<input checked="" type="checkbox"/>	<input checked="" type="checkbox"/>
13	Callers List	Callers List		1	<input checked="" type="checkbox"/>	<input checked="" type="checkbox"/>	<input checked="" type="checkbox"/>	<input checked="" type="checkbox"/>	<input checked="" type="checkbox"/>
14	Intercom	Icom		1	<input checked="" type="checkbox"/>	<input checked="" type="checkbox"/>	<input checked="" type="checkbox"/>	<input checked="" type="checkbox"/>	<input checked="" type="checkbox"/>
15	Services	Services		1	<input checked="" type="checkbox"/>	<input checked="" type="checkbox"/>	<input checked="" type="checkbox"/>	<input checked="" type="checkbox"/>	<input checked="" type="checkbox"/>
16	Empty			1	<input checked="" type="checkbox"/>	<input checked="" type="checkbox"/>	<input checked="" type="checkbox"/>	<input checked="" type="checkbox"/>	<input checked="" type="checkbox"/>
17	None			1	<input checked="" type="checkbox"/>	<input checked="" type="checkbox"/>	<input checked="" type="checkbox"/>	<input checked="" type="checkbox"/>	<input checked="" type="checkbox"/>
18	None			1	<input checked="" type="checkbox"/>	<input checked="" type="checkbox"/>	<input checked="" type="checkbox"/>	<input checked="" type="checkbox"/>	<input checked="" type="checkbox"/>
19	None			1	<input checked="" type="checkbox"/>	<input checked="" type="checkbox"/>	<input checked="" type="checkbox"/>	<input checked="" type="checkbox"/>	<input checked="" type="checkbox"/>
20	None			1	<input checked="" type="checkbox"/>	<input checked="" type="checkbox"/>	<input checked="" type="checkbox"/>	<input checked="" type="checkbox"/>	<input checked="" type="checkbox"/>

Services

XML Application URI:

XML Application Title:

BLF List URI:

Key	Type	Value	Line
1	Services		global
2	Directory		1
3	Callers List		1
4	Intercom		global
5	None		1
6	None		1

Services

BLF List URI:

- For softkeys, select from "**Key 1**" through "**Key 20**".
or
For programmable keys, select from "**Key 1**" through "**Key 6**".
- In the "**Type**" field, select **BLF** to apply to the softkey.
- In the "**Label**" field, enter a label to apply to this softkey.
- In the "**Value**" field, enter the phone number or extension you want to monitor.
- In the "**Line**" field, select a line for which to apply this softkey.
Valid values are 1 through 9.
- If configuring a softkey on the Bottom Keys, in the state fields, check (enable) or uncheck (disable) the states you want to apply to this softkey.
- Click to save your changes.
- Click on **Operation->Reset**.
- In the "**Restart Phone**" field click to restart the IP phone.

Softkeys as BLF List

(For use with the BroadSoft Broadworks Rel 13 or higher platform only)

You can set a softkey to BLF list.

The BLF list feature on the IP phones is specifically designed to support the BroadSoft Broadworks Rel 13 Busy Lamp Field feature. This feature allows the IP phone to subscribe to a list of monitored users defined through the BroadWorks web portal.

Note: Your system administrator must have BLF List enabled on the BroadWorks Server. Contact your system administrator for more information.

In addition to monitoring the idle and busy state, the BLF list feature also supports the ringing state. When the monitored user is idle, there is a small telephone icon shown with the handset on-hook. When the monitored user is on an active call then a small telephone icon is shown with the handset off-hook.

Note: You can also use a BLF/List configured key to dial out.

Example

A receptionist has a 55i running Broadsoft firmware that subscribes to a list of extensions from the BroadWorks Application Server. On the 55i, the softkey LEDs illuminate either flashing, solid, or turn off depending on the state of those extensions.

Note: The Broadworks BLF feature is not the same as the Broadworks Shared Call Appearance (SCA) feature and does not permit call control over the monitored extension.

Setting a BLF List Softkey

The BLF List functions can be configured on the 55i using the Aastra Web UI only. If you set a softkey to use BLF/List, you must also enter a **BLF List URI** at **Operation->Softkeys and XML->Services**. The BLF List URI is the name of the BLF list defined on the BroadSoft BroadWorks Busy Lamp field page for your particular user. For example, my480i-blf-list@as.broadworks.com. The value of the BLF/List URI parameter must match the list name configured. Otherwise, no values display on the 55i screen and the feature is disabled.



- Click on **Operation->Softkeys and XML.**
or
Click on **Operation->Programmable Keys.**

Status

System Information

Operation

User Password

Phone Lock

Softkeys and XML

Programmable Keys

Directory

Reset

Basic Settings

Preferences

Call Forward

Softkeys Configuration

Key	Type	Label	Value	Line	Idle	Connected	Incoming	Outgoing	Busy
1	Line	L1		5	<input checked="" type="checkbox"/>	<input checked="" type="checkbox"/>	<input checked="" type="checkbox"/>	<input checked="" type="checkbox"/>	<input checked="" type="checkbox"/>
2	Speeddial	Home	5555555	1	<input checked="" type="checkbox"/>	<input checked="" type="checkbox"/>	<input checked="" type="checkbox"/>	<input checked="" type="checkbox"/>	<input checked="" type="checkbox"/>
3	Do Not Disturb			1	<input checked="" type="checkbox"/>	<input checked="" type="checkbox"/>	<input checked="" type="checkbox"/>	<input checked="" type="checkbox"/>	<input checked="" type="checkbox"/>
4	BLF	BLF	3333333	1	<input checked="" type="checkbox"/>	<input checked="" type="checkbox"/>	<input checked="" type="checkbox"/>	<input checked="" type="checkbox"/>	<input checked="" type="checkbox"/>
5	BLF/List			1	<input checked="" type="checkbox"/>	<input checked="" type="checkbox"/>	<input checked="" type="checkbox"/>	<input checked="" type="checkbox"/>	<input checked="" type="checkbox"/>
6	XML	Stocks	http://stocks.com	1	<input checked="" type="checkbox"/>	<input checked="" type="checkbox"/>	<input checked="" type="checkbox"/>	<input checked="" type="checkbox"/>	<input checked="" type="checkbox"/>
7	Flash	Flash		1	<input checked="" type="checkbox"/>	<input checked="" type="checkbox"/>	<input checked="" type="checkbox"/>	<input checked="" type="checkbox"/>	<input checked="" type="checkbox"/>
8	Spcode	Spcode	*80	1	<input checked="" type="checkbox"/>	<input checked="" type="checkbox"/>	<input checked="" type="checkbox"/>	<input checked="" type="checkbox"/>	<input checked="" type="checkbox"/>
9	Park	John	*700	1	<input checked="" type="checkbox"/>	<input checked="" type="checkbox"/>	<input checked="" type="checkbox"/>	<input checked="" type="checkbox"/>	<input checked="" type="checkbox"/>
10	Pickup	James	*700	1	<input checked="" type="checkbox"/>	<input checked="" type="checkbox"/>	<input checked="" type="checkbox"/>	<input checked="" type="checkbox"/>	<input checked="" type="checkbox"/>
11	Last Call Return			1	<input checked="" type="checkbox"/>	<input checked="" type="checkbox"/>	<input checked="" type="checkbox"/>	<input checked="" type="checkbox"/>	<input checked="" type="checkbox"/>
12	Directory	Dir		1	<input checked="" type="checkbox"/>	<input checked="" type="checkbox"/>	<input checked="" type="checkbox"/>	<input checked="" type="checkbox"/>	<input checked="" type="checkbox"/>
13	Callers List	Callers List		1	<input checked="" type="checkbox"/>	<input checked="" type="checkbox"/>	<input checked="" type="checkbox"/>	<input checked="" type="checkbox"/>	<input checked="" type="checkbox"/>
14	Intercom	Intercom		1	<input checked="" type="checkbox"/>	<input checked="" type="checkbox"/>	<input checked="" type="checkbox"/>	<input checked="" type="checkbox"/>	<input checked="" type="checkbox"/>
15	Services	Services		1	<input checked="" type="checkbox"/>	<input checked="" type="checkbox"/>	<input checked="" type="checkbox"/>	<input checked="" type="checkbox"/>	<input checked="" type="checkbox"/>
16	Empty			1	<input checked="" type="checkbox"/>	<input checked="" type="checkbox"/>	<input checked="" type="checkbox"/>	<input checked="" type="checkbox"/>	<input checked="" type="checkbox"/>
17	None			1	<input checked="" type="checkbox"/>	<input checked="" type="checkbox"/>	<input checked="" type="checkbox"/>	<input checked="" type="checkbox"/>	<input checked="" type="checkbox"/>
18	None			1	<input checked="" type="checkbox"/>	<input checked="" type="checkbox"/>	<input checked="" type="checkbox"/>	<input checked="" type="checkbox"/>	<input checked="" type="checkbox"/>
19	None			1	<input checked="" type="checkbox"/>	<input checked="" type="checkbox"/>	<input checked="" type="checkbox"/>	<input checked="" type="checkbox"/>	<input checked="" type="checkbox"/>
20	None			1	<input checked="" type="checkbox"/>	<input checked="" type="checkbox"/>	<input checked="" type="checkbox"/>	<input checked="" type="checkbox"/>	<input checked="" type="checkbox"/>

Services

XML Application URI:

XML Application Title:

BLF List URI:

Status

System Information

Operation

User Password

Phone Lock

Softkeys and XML

Programmable Keys

Directory

Reset

Basic Settings

Preferences

Call Forward

Programmable Keys Configuration

Key	Type	Value	Line
1	Services		global
2	Directory		1
3	Callers List		1
4	Intercom		global
5	None		1
6	None		1

Services

BLF List URI:

- For softkeys, select from **"Key 1"** through **"Key 20"**.
or
For programmable keys, select from **"Key 1"** through **"Key 6"**.
 - In the **"Type"** field, select **"BLF/List"** (BroadSoft BroadWorks).
- Note:** The "Label" and "Value" field are not required. The BroadWorks BLF List

name is configured in the "BLF List URI" field instead.

4. In the "**Line**" field, select a line number that is actively registered to the appropriate SIP proxy you are using.
5. If configuring a softkey on the Bottom Keys, in the state fields, check (enable) or uncheck (disable) the states you want to apply to this softkey.
6. In the "**BLF List URI**" field, enter the name of the BLF list defined on the BroadSoft BroadWorks Busy Lamp field page for your particular user. For example, my53i-blf-list@as.broadworks.com.

Note: Contact your System Administrator for the BLF List URI.

7. Click to save your changes.
8. Click on **Operation->Reset**.
9. In the "**Restart Phone**" field click to restart the IP phone.

Softkeys for Accessing XML Services

The 55i IP phone has a feature you can enable called "**XML**" (Extensible Markup Language). XML is a markup language much like HTML. Your system administrator can create customized XML menu services and load them to your IP phone. These services include things like weather and traffic reports, contact information, company info, stock quotes, or custom call scripts.

Note: You can configure XML using the Aastra Web UI only.

On the 55i IP phone, you can access the XML applications from the IP Phone UI in two ways:

- Via the "**Services**" menu
- Via an XML softkey

Note: The XML services must be set up by your system administrator before you can use the key. Contact your system administrator for more information.

By default, the Services key is the first key on the "Top" softkeys.

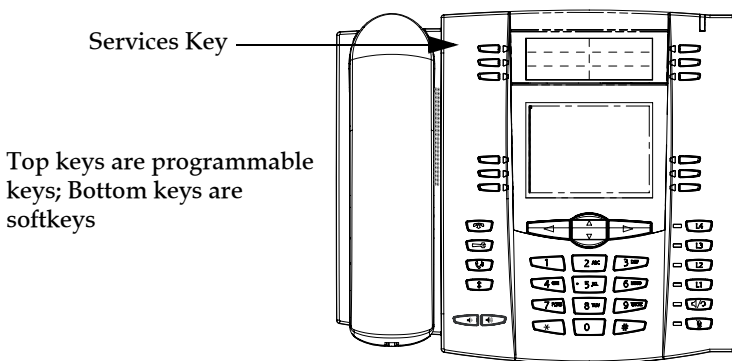

Using the Aastra Web UI, you can setup the Services menu on the IP phone to display XML applications. Under **Operations->Softkeys and XML**, you can click on the "**Top Keys**" tab and enter the XML URI and Services Label in the "XML Application URI" and XML Application Title" fields, respectively.

Note: Contact your system administrator for the applicable URI to enter in this field. After the Services menu is configured, you can use the IP Phone UI and press the Services key to access the XML applications.

Using the Aastra Web UI, you can also configure a softkey to access XML applications. Under **Operations->Softkeys and XML**, you can click on the "Bottom Keys" or "Top Keys" tabs and assign a key type as "**XML**". You must also set the following for XML softkeys:

- **XML Application URI**
- **XML Application Title**

The XML Application URI is the URI loaded by your phone. The phone performs an HTTP GET. Contact your system administrator for the applicable XML URI to enter in the "XML Application URI" field.

The XML Application Title is the label that displays beside the XML softkey on your phone. If you use the Services key to access the XML features, the "XML Application Title" is the label that displays on the Services Menu in the IP Phone UI.

Setting XML Services



Aastra Web UI

1. Click on Operation->Programmable Keys.

Status

System Information

Operation

User Password

Phone Lock

Softkeys and XML

Programmable Keys

Directory

Reset

Basic Settings

Preferences

Call Forward

Softkeys Configuration

Key	Type	Label	Value	Line	Idle	Connected	Incoming	Outgoing	Busy
1	Line	L1		5	<input checked="" type="checkbox"/>	<input checked="" type="checkbox"/>	<input checked="" type="checkbox"/>	<input checked="" type="checkbox"/>	<input checked="" type="checkbox"/>
2	Speeddial	Home	5555555	1	<input checked="" type="checkbox"/>	<input checked="" type="checkbox"/>	<input checked="" type="checkbox"/>	<input checked="" type="checkbox"/>	<input checked="" type="checkbox"/>
3	Do Not Disturb			1	<input checked="" type="checkbox"/>	<input checked="" type="checkbox"/>	<input checked="" type="checkbox"/>	<input checked="" type="checkbox"/>	<input checked="" type="checkbox"/>
4	BLF	BLF	3333333	1	<input checked="" type="checkbox"/>	<input checked="" type="checkbox"/>	<input checked="" type="checkbox"/>	<input checked="" type="checkbox"/>	<input checked="" type="checkbox"/>
5	BLF/List			1	<input checked="" type="checkbox"/>	<input checked="" type="checkbox"/>	<input checked="" type="checkbox"/>	<input checked="" type="checkbox"/>	<input checked="" type="checkbox"/>
6	XML	Stoda	http://stoda.com	1	<input checked="" type="checkbox"/>	<input checked="" type="checkbox"/>	<input checked="" type="checkbox"/>	<input checked="" type="checkbox"/>	<input checked="" type="checkbox"/>
7	Flash	Flash		1	<input checked="" type="checkbox"/>	<input checked="" type="checkbox"/>	<input checked="" type="checkbox"/>	<input checked="" type="checkbox"/>	<input checked="" type="checkbox"/>
8	Spreecode	Spreecode	*80	1	<input checked="" type="checkbox"/>	<input checked="" type="checkbox"/>	<input checked="" type="checkbox"/>	<input checked="" type="checkbox"/>	<input checked="" type="checkbox"/>
9	Park	John	*700	1	<input checked="" type="checkbox"/>	<input checked="" type="checkbox"/>	<input checked="" type="checkbox"/>	<input checked="" type="checkbox"/>	<input checked="" type="checkbox"/>
10	Pickup	James	*700	1	<input checked="" type="checkbox"/>	<input checked="" type="checkbox"/>	<input checked="" type="checkbox"/>	<input checked="" type="checkbox"/>	<input checked="" type="checkbox"/>
11	Last Call Return			1	<input checked="" type="checkbox"/>	<input checked="" type="checkbox"/>	<input checked="" type="checkbox"/>	<input checked="" type="checkbox"/>	<input checked="" type="checkbox"/>
12	Directory	Dir		1	<input checked="" type="checkbox"/>	<input checked="" type="checkbox"/>	<input checked="" type="checkbox"/>	<input checked="" type="checkbox"/>	<input checked="" type="checkbox"/>
13	Callers List	Callers List		1	<input checked="" type="checkbox"/>	<input checked="" type="checkbox"/>	<input checked="" type="checkbox"/>	<input checked="" type="checkbox"/>	<input checked="" type="checkbox"/>
14	Intercom	loom		1	<input checked="" type="checkbox"/>	<input checked="" type="checkbox"/>	<input checked="" type="checkbox"/>	<input checked="" type="checkbox"/>	<input checked="" type="checkbox"/>
15	Services	Services		1	<input checked="" type="checkbox"/>	<input checked="" type="checkbox"/>	<input checked="" type="checkbox"/>	<input checked="" type="checkbox"/>	<input checked="" type="checkbox"/>
16	Empty			1	<input checked="" type="checkbox"/>	<input checked="" type="checkbox"/>	<input checked="" type="checkbox"/>	<input checked="" type="checkbox"/>	<input checked="" type="checkbox"/>
17	None			1	<input checked="" type="checkbox"/>	<input checked="" type="checkbox"/>	<input checked="" type="checkbox"/>	<input checked="" type="checkbox"/>	<input checked="" type="checkbox"/>
18	None			1	<input checked="" type="checkbox"/>	<input checked="" type="checkbox"/>	<input checked="" type="checkbox"/>	<input checked="" type="checkbox"/>	<input checked="" type="checkbox"/>
19	None			1	<input checked="" type="checkbox"/>	<input checked="" type="checkbox"/>	<input checked="" type="checkbox"/>	<input checked="" type="checkbox"/>	<input checked="" type="checkbox"/>
20	None			1	<input checked="" type="checkbox"/>	<input checked="" type="checkbox"/>	<input checked="" type="checkbox"/>	<input checked="" type="checkbox"/>	<input checked="" type="checkbox"/>

Services

XML Application URI:

XML Application Title:

BLF List URI:

Status

System Information

Operation

User Password

Phone Lock

Softkeys and XML

Programmable Keys

Directory

Reset

Basic Settings

Preferences

Call Forward

Programmable Keys Configuration

Key	Type	Value	Line
1	Services		global
2	Directory		1
3	Callers List		1
4	Intercom		global
5	None		1
6	None		1

Services

BLF List URI:

Softkeys and Programmable Keys

2. Select "**Key 1**" (Services).
3. In the "**Type**" field, select "**XML**".
4. If configuring a softkey on the Bottom Keys, in the state fields, check (enable) or uncheck (disable) the states you want to apply to this softkey.
5. Under the "**Services**" section in the "**XML Application URI**" field, enter the applicable URI(s) .
6. in the "**XML Application Title**" field, enter the applicable label to display for the Services Menu .

Note: Contact your system administrator for the appropriate value(s) to enter in the "XML Application URI" field.

7. Click to save your changes.

8. Click on **Operation->Reset**.

9. In the **"Restart Phone"** field click to restart the IP phone.

Setting an XML Softkey



Aastra Web UI

1. Click on **Operation->Softkeys and XML**.

or

Click on **Operation->Programmable Keys**.

Status

System Information

Operation

User Password

Phone Lock

Softkeys and XML

Programmable Keys

Directory

Reset

Basic Settings

Preferences

Call Forward

Softkeys Configuration

Key	Type	Label	Value	Line	Idle	Connected	Incoming	Outgoing	Busy
1	Line	L1		5	<input checked="" type="checkbox"/>	<input checked="" type="checkbox"/>	<input checked="" type="checkbox"/>	<input checked="" type="checkbox"/>	<input checked="" type="checkbox"/>
2	Speeddial	Home	5555555	1	<input checked="" type="checkbox"/>	<input checked="" type="checkbox"/>	<input checked="" type="checkbox"/>	<input checked="" type="checkbox"/>	<input checked="" type="checkbox"/>
3	Do Not Disturb			1	<input checked="" type="checkbox"/>	<input checked="" type="checkbox"/>	<input checked="" type="checkbox"/>	<input checked="" type="checkbox"/>	<input checked="" type="checkbox"/>
4	BLF	BLF	3333333	1	<input checked="" type="checkbox"/>	<input checked="" type="checkbox"/>	<input checked="" type="checkbox"/>	<input checked="" type="checkbox"/>	<input checked="" type="checkbox"/>
5	BLF/List			1	<input checked="" type="checkbox"/>	<input checked="" type="checkbox"/>	<input checked="" type="checkbox"/>	<input checked="" type="checkbox"/>	<input checked="" type="checkbox"/>
6	XML	Stoda	http://stoda.com	1	<input checked="" type="checkbox"/>	<input checked="" type="checkbox"/>	<input checked="" type="checkbox"/>	<input checked="" type="checkbox"/>	<input checked="" type="checkbox"/>
7	Flash	Flash		1	<input checked="" type="checkbox"/>	<input checked="" type="checkbox"/>	<input checked="" type="checkbox"/>	<input checked="" type="checkbox"/>	<input checked="" type="checkbox"/>
8	Sprecode	Sprecode	*80	1	<input checked="" type="checkbox"/>	<input checked="" type="checkbox"/>	<input checked="" type="checkbox"/>	<input checked="" type="checkbox"/>	<input checked="" type="checkbox"/>
9	Park	John	*700	1	<input checked="" type="checkbox"/>	<input checked="" type="checkbox"/>	<input checked="" type="checkbox"/>	<input checked="" type="checkbox"/>	<input checked="" type="checkbox"/>
10	Pickup	James	*700	1	<input checked="" type="checkbox"/>	<input checked="" type="checkbox"/>	<input checked="" type="checkbox"/>	<input checked="" type="checkbox"/>	<input checked="" type="checkbox"/>
11	Last Call Return			1	<input checked="" type="checkbox"/>	<input checked="" type="checkbox"/>	<input checked="" type="checkbox"/>	<input checked="" type="checkbox"/>	<input checked="" type="checkbox"/>
12	Directory	Dir		1	<input checked="" type="checkbox"/>	<input checked="" type="checkbox"/>	<input checked="" type="checkbox"/>	<input checked="" type="checkbox"/>	<input checked="" type="checkbox"/>
13	Callers List	Callers List		1	<input checked="" type="checkbox"/>	<input checked="" type="checkbox"/>	<input checked="" type="checkbox"/>	<input checked="" type="checkbox"/>	<input checked="" type="checkbox"/>
14	Intercom	locom		1	<input checked="" type="checkbox"/>	<input checked="" type="checkbox"/>	<input checked="" type="checkbox"/>	<input checked="" type="checkbox"/>	<input checked="" type="checkbox"/>
15	Services	Services		1	<input checked="" type="checkbox"/>	<input checked="" type="checkbox"/>	<input checked="" type="checkbox"/>	<input checked="" type="checkbox"/>	<input checked="" type="checkbox"/>
16	Empty			1	<input checked="" type="checkbox"/>	<input checked="" type="checkbox"/>	<input checked="" type="checkbox"/>	<input checked="" type="checkbox"/>	<input checked="" type="checkbox"/>
17	None			1	<input checked="" type="checkbox"/>	<input checked="" type="checkbox"/>	<input checked="" type="checkbox"/>	<input checked="" type="checkbox"/>	<input checked="" type="checkbox"/>
18	None			1	<input checked="" type="checkbox"/>	<input checked="" type="checkbox"/>	<input checked="" type="checkbox"/>	<input checked="" type="checkbox"/>	<input checked="" type="checkbox"/>
19	None			1	<input checked="" type="checkbox"/>	<input checked="" type="checkbox"/>	<input checked="" type="checkbox"/>	<input checked="" type="checkbox"/>	<input checked="" type="checkbox"/>
20	None			1	<input checked="" type="checkbox"/>	<input checked="" type="checkbox"/>	<input checked="" type="checkbox"/>	<input checked="" type="checkbox"/>	<input checked="" type="checkbox"/>

Services

XML Application URI:

XML Application Title:

BLF List URI:

Status

System Information

Operation

User Password

Phone Lock

Softkeys and XML

Programmable Keys

Directory

Reset

Basic Settings

Preferences

Call Forward

Programmable Keys Configuration

Key	Type	Value	Line
1	Services		global
2	Directory		1
3	Callers List		1
4	Intercom		global
5	None		1
6	None		1

Services

BLF List URI:

Softkeys and Programmable Keys

2. For softkeys, select from "**Key 1**" through "**Key 20**".
or
For programmable keys, select from "**Key 1**" through "**Key 6**".
3. In the "**Type**" field, select "**XML**".
4. In the "**Label**" field, enter a label to apply to this softkey.
5. In the "**Value**" field, enter a URI to apply to this softkey.
Note: Contact your system administrator for the appropriate value(s) to enter in the "Value" field.
6. If configuring a softkey on the Bottom Keys, in the state fields, check (enable) or uncheck (disable) the states you want to apply to this softkey.
7. Click to save your changes.
8. Click on **Operation->Reset**.
9. In the "**Restart Phone**" field click to restart the IP phone.

Accessing the XML Service

After an XML application(s) has been saved to your IP phone, and either the Services Menu or a softkey have been configured to access the XML applications, the customized service is ready for you to use.





IP Phone UI

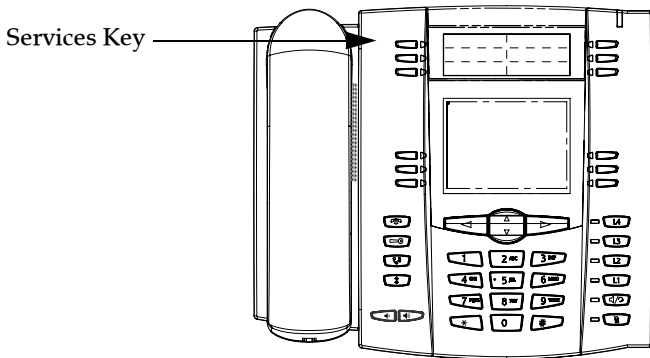

From the Services Menu

Use the following procedure to access XML applications from the Services Menu. Use the following illustration as a reference.



1. Press the **Services** key.
2. Use the  and  to scroll through the items.
3. For menu and directory services, select a service to display the information for that customized service. Message services display to the screen after pressing the programmable key. For user input services, follow the prompts as appropriate.
4. To exit from the "**Services**" menu, press the Services key again.

From an XML Softkey

1. Press the XML softkey on the 55i phone. A "**Custom Features**" screen displays or the title you specified.
2. Use the  and  to scroll through the customized features.
3. For menu and directory services, select a service to display the information for that customized service. Message services display to the screen after pressing the programmable key. For user input services, follow the prompts as appropriate.
4. To exit from the "**Customized Features**" screen, press the XML softkey again.

Softkeys as Flash Key

You can set a softkey to generate a flash event when it is pressed on the 55i or 55i handset. You do this by setting the softkey to **"flash"**. The IP phone generates flash events only when a call is connected and there is an active RTP stream (for example, when the call is not on hold).

Setting a Flash Softkey



Astra Web UI

1. Click on **Operation->Softkeys and XML**.

or

Click on **Operation->Programmable Keys**.

Status

System Information

Operation

User Password

Phone Lock

Softkeys and XML

Programmable Keys

Directory

Reset

Basic Settings

Preferences

Call Forward

Softkeys Configuration

Key	Type	Label	Value	Line	Idle	Connected	Incoming	Outgoing	Busy
1	Line	L1		5	<input checked="" type="checkbox"/>	<input checked="" type="checkbox"/>	<input checked="" type="checkbox"/>	<input checked="" type="checkbox"/>	<input checked="" type="checkbox"/>
2	Speeddial	Home	5555555	1	<input checked="" type="checkbox"/>	<input checked="" type="checkbox"/>	<input checked="" type="checkbox"/>	<input checked="" type="checkbox"/>	<input checked="" type="checkbox"/>
3	Do Not Disturb			1	<input checked="" type="checkbox"/>	<input checked="" type="checkbox"/>	<input checked="" type="checkbox"/>	<input checked="" type="checkbox"/>	<input checked="" type="checkbox"/>
4	BLF	BLF	3333333	1	<input checked="" type="checkbox"/>	<input checked="" type="checkbox"/>	<input checked="" type="checkbox"/>	<input checked="" type="checkbox"/>	<input checked="" type="checkbox"/>
5	BLF/List			1	<input checked="" type="checkbox"/>	<input checked="" type="checkbox"/>	<input checked="" type="checkbox"/>	<input checked="" type="checkbox"/>	<input checked="" type="checkbox"/>
6	XML	Stods	http://stods.com	1	<input checked="" type="checkbox"/>	<input checked="" type="checkbox"/>	<input checked="" type="checkbox"/>	<input checked="" type="checkbox"/>	<input checked="" type="checkbox"/>
7	Flash	Flash		1	<input checked="" type="checkbox"/>	<input checked="" type="checkbox"/>	<input checked="" type="checkbox"/>	<input checked="" type="checkbox"/>	<input checked="" type="checkbox"/>
8	Spcode	Spcode	*80	1	<input checked="" type="checkbox"/>	<input checked="" type="checkbox"/>	<input checked="" type="checkbox"/>	<input checked="" type="checkbox"/>	<input checked="" type="checkbox"/>
9	Park	John	*700	1	<input checked="" type="checkbox"/>	<input checked="" type="checkbox"/>	<input checked="" type="checkbox"/>	<input checked="" type="checkbox"/>	<input checked="" type="checkbox"/>
10	Pickup	James	*700	1	<input checked="" type="checkbox"/>	<input checked="" type="checkbox"/>	<input checked="" type="checkbox"/>	<input checked="" type="checkbox"/>	<input checked="" type="checkbox"/>
11	Last Call Return			1	<input checked="" type="checkbox"/>	<input checked="" type="checkbox"/>	<input checked="" type="checkbox"/>	<input checked="" type="checkbox"/>	<input checked="" type="checkbox"/>
12	Directory	Dir		1	<input checked="" type="checkbox"/>	<input checked="" type="checkbox"/>	<input checked="" type="checkbox"/>	<input checked="" type="checkbox"/>	<input checked="" type="checkbox"/>
13	Callers List	Callers List		1	<input checked="" type="checkbox"/>	<input checked="" type="checkbox"/>	<input checked="" type="checkbox"/>	<input checked="" type="checkbox"/>	<input checked="" type="checkbox"/>
14	Intercom	Isom		1	<input checked="" type="checkbox"/>	<input checked="" type="checkbox"/>	<input checked="" type="checkbox"/>	<input checked="" type="checkbox"/>	<input checked="" type="checkbox"/>
15	Services	Services		1	<input checked="" type="checkbox"/>	<input checked="" type="checkbox"/>	<input checked="" type="checkbox"/>	<input checked="" type="checkbox"/>	<input checked="" type="checkbox"/>
16	Empty			1	<input checked="" type="checkbox"/>	<input checked="" type="checkbox"/>	<input checked="" type="checkbox"/>	<input checked="" type="checkbox"/>	<input checked="" type="checkbox"/>
17	None			1	<input checked="" type="checkbox"/>	<input checked="" type="checkbox"/>	<input checked="" type="checkbox"/>	<input checked="" type="checkbox"/>	<input checked="" type="checkbox"/>
18	None			1	<input checked="" type="checkbox"/>	<input checked="" type="checkbox"/>	<input checked="" type="checkbox"/>	<input checked="" type="checkbox"/>	<input checked="" type="checkbox"/>
19	None			1	<input checked="" type="checkbox"/>	<input checked="" type="checkbox"/>	<input checked="" type="checkbox"/>	<input checked="" type="checkbox"/>	<input checked="" type="checkbox"/>
20	None			1	<input checked="" type="checkbox"/>	<input checked="" type="checkbox"/>	<input checked="" type="checkbox"/>	<input checked="" type="checkbox"/>	<input checked="" type="checkbox"/>

Services

XML Application URI:

XML Application Title:

BLF List URI:

Status

System Information

Operation

User Password

Phone Lock

Softkeys and XML

Programmable Keys

Directory

Reset

Basic Settings

Preferences

Call Forward

Programmable Keys Configuration

Key	Type	Value	Line
1	Services		global
2	Directory		1
3	Callers List		1
4	Intercom		global
5	None		1
6	None		1

Services

BLF List URI:

2. For softkeys, select from "**Key 1**" through "**Key 20**".
or
For programmable keys, select from "**Key 1**" through "**Key 6**".
3. In the "**Type**" field, select "**Flash**".
4. In the "**Label**" field, enter a label to display on the phone for the softkey.
5. Click to save your changes.
6. Click on **Operation->Reset**.
7. In the "**Restart Phone**" field click to restart the IP phone.

Softkeys as Sprecode

You can set a softkey to automatically activate specific services offered by the server by setting a softkey to "**sprecode**". For example, if the sprecode value of *82 is configured, then by pressing the softkey, *82 automatically activates a service provided by the server. The value you enter for this field is dependent on the services provided by the server. Contact your system administrator for information about available services.

Setting a Sprecode Softkey



Aastra Web UI

Use the following procedure to configure a sprecode softkey on the 55i phone.

1. Click on **Operation->Softkeys and XML.**
or
Click on **Operation->Programmable Keys.**

Status

System information

Operation

User Password

Phone Lock

Softkeys and XML

Programmable Keys

Directory

Reset

Basic Settings

Preferences

Call Forward

Softkeys Configuration

Key	Type	Label	Value	Line	Idle	Connected	Incoming	Outgoing	Busy
1	Line	L1		5	<input checked="" type="checkbox"/>	<input checked="" type="checkbox"/>	<input checked="" type="checkbox"/>	<input checked="" type="checkbox"/>	<input checked="" type="checkbox"/>
2	Speedial	Home	5555555	1	<input checked="" type="checkbox"/>	<input checked="" type="checkbox"/>	<input checked="" type="checkbox"/>	<input checked="" type="checkbox"/>	<input checked="" type="checkbox"/>
3	Do Not Disturb			1	<input checked="" type="checkbox"/>	<input checked="" type="checkbox"/>	<input checked="" type="checkbox"/>	<input checked="" type="checkbox"/>	<input checked="" type="checkbox"/>
4	BLF	BLF	3333333	1	<input checked="" type="checkbox"/>	<input checked="" type="checkbox"/>	<input checked="" type="checkbox"/>	<input checked="" type="checkbox"/>	<input checked="" type="checkbox"/>
5	BLF/List			1	<input checked="" type="checkbox"/>	<input checked="" type="checkbox"/>	<input checked="" type="checkbox"/>	<input checked="" type="checkbox"/>	<input checked="" type="checkbox"/>
6	XML	Stocks	http://stocks.com	1	<input checked="" type="checkbox"/>	<input checked="" type="checkbox"/>	<input checked="" type="checkbox"/>	<input checked="" type="checkbox"/>	<input checked="" type="checkbox"/>
7	Flash	Flash		1	<input checked="" type="checkbox"/>	<input checked="" type="checkbox"/>	<input checked="" type="checkbox"/>	<input checked="" type="checkbox"/>	<input checked="" type="checkbox"/>
8	Sprecode	Sprecode	*80	1	<input checked="" type="checkbox"/>	<input checked="" type="checkbox"/>	<input checked="" type="checkbox"/>	<input checked="" type="checkbox"/>	<input checked="" type="checkbox"/>
9	Park	John	*700	1	<input checked="" type="checkbox"/>	<input checked="" type="checkbox"/>	<input checked="" type="checkbox"/>	<input checked="" type="checkbox"/>	<input checked="" type="checkbox"/>
10	Pickup	James	*700	1	<input checked="" type="checkbox"/>	<input checked="" type="checkbox"/>	<input checked="" type="checkbox"/>	<input checked="" type="checkbox"/>	<input checked="" type="checkbox"/>
11	Last Call Return			1	<input checked="" type="checkbox"/>	<input checked="" type="checkbox"/>	<input checked="" type="checkbox"/>	<input checked="" type="checkbox"/>	<input checked="" type="checkbox"/>
12	Directory	Dir		1	<input checked="" type="checkbox"/>	<input checked="" type="checkbox"/>	<input checked="" type="checkbox"/>	<input checked="" type="checkbox"/>	<input checked="" type="checkbox"/>
13	Callers List	Callers List		1	<input checked="" type="checkbox"/>	<input checked="" type="checkbox"/>	<input checked="" type="checkbox"/>	<input checked="" type="checkbox"/>	<input checked="" type="checkbox"/>
14	Intercom	Icom		1	<input checked="" type="checkbox"/>	<input checked="" type="checkbox"/>	<input checked="" type="checkbox"/>	<input checked="" type="checkbox"/>	<input checked="" type="checkbox"/>
15	Services	Services		1	<input checked="" type="checkbox"/>	<input checked="" type="checkbox"/>	<input checked="" type="checkbox"/>	<input checked="" type="checkbox"/>	<input checked="" type="checkbox"/>
16	Empty			1	<input checked="" type="checkbox"/>	<input checked="" type="checkbox"/>	<input checked="" type="checkbox"/>	<input checked="" type="checkbox"/>	<input checked="" type="checkbox"/>
17	None			1	<input checked="" type="checkbox"/>	<input checked="" type="checkbox"/>	<input checked="" type="checkbox"/>	<input checked="" type="checkbox"/>	<input checked="" type="checkbox"/>
18	None			1	<input checked="" type="checkbox"/>	<input checked="" type="checkbox"/>	<input checked="" type="checkbox"/>	<input checked="" type="checkbox"/>	<input checked="" type="checkbox"/>
19	None			1	<input checked="" type="checkbox"/>	<input checked="" type="checkbox"/>	<input checked="" type="checkbox"/>	<input checked="" type="checkbox"/>	<input checked="" type="checkbox"/>
20	None			1	<input checked="" type="checkbox"/>	<input checked="" type="checkbox"/>	<input checked="" type="checkbox"/>	<input checked="" type="checkbox"/>	<input checked="" type="checkbox"/>

Services

XML Application URI:

XML Application Title:

BLF List URI:

Key	Type	Value	Line
1	Services		global
2	Directory		1
3	Callers List		1
4	Intercom		global
5	None		1
6	None		1

Services

BLF List URI:

2. For softkeys, select from "**Key 1**" through "**Key 20**".
or
For programmable keys, select from "**Key 1**" through "**Key 6**".
3. In the "**Type**" field, select **Sprecode**.
4. In the "**Label**" field, enter a label to display on the IP phone for this softkey.
5. In the "**Value**" field, enter the appropriate value for accessing specific services from the server.
Note: For values to enter in this field, contact your system administrator.
6. If configuring a softkey on the Bottom Keys, in the state fields, check (enable) or uncheck (disable) the "**Connected**" state to apply to this softkey.
7. Click to save your changes.
8. Click on **Operation->Reset**.
9. In the "**Restart Phone**" field click to restart the IP phone.

Static and Softkey Settings for Park/Pickup

The IP phone has a park and pickup call feature that allows you to park a call and pickup a call when required. There are two ways a user can configure this feature:

- Using a static configuration
- Using a programmable configuration (using softkeys)

Note: The IP phone accepts both methods of configuration. However, to avoid redundancy, Aastra Telecom recommends you configure either a static configuration or a programmable configuration.

The IP phone supports the Park/Pickup feature on the Asterisk, BroadWorks, Sylantró, and ININ PBX servers.

The following paragraphs describe the park and pickup methods of configuration on the IP phones.

Park/Pickup Static Configuration

You can configure a static configuration for parking and picking up a call using the Aastra Web UI at **Basic Settings-> Preferences**. By entering the appropriate value in the "**Park Call**" and "**Pickup Parked Call**" fields, you tell the phone where to park a live call and where to pickup the parked call.

On the IP phone UI, the static configuration method displays the following:

- When a call comes in, and you pickup the handset, the default label of "**Park**" displays on the Phone UI.
- After pressing the "**Park**" softkey to park the call, the default label of "**Pickup**" displays on the phone UI.

Note: On the 55i handset, pressing  displays the "Park" and "Pickup" labels.

The values you enter in the Aastra Web UI for the Park/Pickup call feature are dependant on your type of server. The following table provides the values you enter for the "**Park Call**" and "**Pickup Parked Call**" fields in the Aastra Web UI.

Park/Pickup Call Server Configuration Values

Server	Park Values*	Pickup Values*
Aasterisk	700	700
Sylantró	*98	*99
BroadWorks	*68	*88
ININ PBX	callpark	pickup

*Leave "value" fields blank to disable the park and pickup feature.

Configuring Park /Pickup using Static Configuration

Use the following procedure to configure the Park/Pickup call feature using the static configuration method.

Note: Aastra recommends you configure either the static or the programmable configuration, but not both.



Aastra Web UI

1. Click on **Basic Settings->Preferences->General.**

Preferences	
General	
Park Call:	<input type="text"/>
Pick Up Parked Call:	<input type="text"/>
Suppress DTMF Playback	<input type="checkbox"/> Enabled
Display DTMF Digits	<input type="checkbox"/> Enabled
Play Call Waiting Tone	<input checked="" type="checkbox"/> Enabled
Stuttered Dial Tone	<input checked="" type="checkbox"/> Enabled
Incoming Intercom Settings	
Auto-Answer	<input checked="" type="checkbox"/> Enabled
Microphone Mute	<input checked="" type="checkbox"/> Enabled
Play Warning Tone	<input checked="" type="checkbox"/> Enabled
Ring Tones	
Tone Set	US <input type="button" value="v"/>
Global Ring Tone	Tone 2 <input type="button" value="v"/>
Line 1	Global <input type="button" value="v"/>
Line 2	Global <input type="button" value="v"/>
Line 3	Global <input type="button" value="v"/>
Line 4	Global <input type="button" value="v"/>
Line 5	Global <input type="button" value="v"/>
Line 6	Global <input type="button" value="v"/>
Line 7	Global <input type="button" value="v"/>
Line 8	Global <input type="button" value="v"/>
Line 9	Global <input type="button" value="v"/>
Time and Date Setting	
Time Format	12h <input type="button" value="v"/>
Date Format	WWW MMM DD <input type="button" value="v"/>
Language Settings	
Webpage Language	English <input type="button" value="v"/>
<input type="button" value="Save Settings"/>	

2. Enter a server value in the **Park Call** field to which incoming live calls will be parked.

Note: For values to enter in this field, see the table "[Park/Pickup Call Server Configuration Values](#)" on page 54.

3. Enter a server value in the "**Pickup Parked Call**" field.

Note: For values to enter in this field, see the table "[Park/Pickup Call Server Configuration Values](#)" on [page 54](#).

4. Click  to save your changes.

5. Click on **Operation->Reset**.

6. In the "**Restart Phone**" field click  to restart the IP phone.

Park/Pickup Softkey Configuration

The programmable method of configuration creates park and pickup softkeys that you can configure on the 55i phone.

You can set a softkey as "Park" or "Pickup" and then:

- specify a customized label to display on the Phone UI
- specify a value
- specify which line to use
- specify the state of the park and/or pickup keys

On the IP phone UI, the Park/Pickup feature displays the following:

- When a call comes in, and you pickup the handset, the custom label that you configured for the Park softkey displays on the Phone UI.
- After the call is parked, the label that you configured for the Pickup softkey displays on other phones in the network. You can then press the "Pickup" softkey, followed by the applicable value to pickup the call on another phone in your network.

You can configure a Park and Pickup programmable configuration using the Aastra Web UI.

Softkey Configuration Using the Aastra Web UI

On the 55i, you configure a Park and/or Pickup key at **Operation->Softkeys and XML**. You enter a key label, and value for a specific line on the phone. The default state of the Park configuration is "**connected**". The default state of the Pickup configuration is "**idle, outgoing**".

Note: Applicable values depend on the server in your network (Asterisk, BroadWorks, Sylantrio, ININ PBX). See the table "[Park/Pickup Call Server Configuration Values](#)" on [page 54](#).

Configuring Park/Pickup using Softkey Configuration

Use the following procedure to configure the Park/Pickup call feature using the softkey configuration method.



1. Click on **Operation->Softkeys and XML**.
or
Click on **Operation->Programmable Keys**.

Key	Type	Label	Value	Line	kile	Connected	Incoming	Outgoing	Busy
1	Line	L1		5	<input checked="" type="checkbox"/>	<input checked="" type="checkbox"/>	<input checked="" type="checkbox"/>	<input checked="" type="checkbox"/>	<input checked="" type="checkbox"/>
2	Speeddial	Home	5555555	1	<input checked="" type="checkbox"/>	<input checked="" type="checkbox"/>	<input checked="" type="checkbox"/>	<input checked="" type="checkbox"/>	<input checked="" type="checkbox"/>
3	Do Not Disturb			1	<input checked="" type="checkbox"/>	<input checked="" type="checkbox"/>	<input checked="" type="checkbox"/>	<input checked="" type="checkbox"/>	<input checked="" type="checkbox"/>
4	BLF	BLF	3333333	1	<input checked="" type="checkbox"/>	<input checked="" type="checkbox"/>	<input checked="" type="checkbox"/>	<input checked="" type="checkbox"/>	<input checked="" type="checkbox"/>
5	BLF/List			1	<input checked="" type="checkbox"/>	<input checked="" type="checkbox"/>	<input checked="" type="checkbox"/>	<input checked="" type="checkbox"/>	<input checked="" type="checkbox"/>
6	XML	Stoda	http://stoda.com	1	<input checked="" type="checkbox"/>	<input checked="" type="checkbox"/>	<input checked="" type="checkbox"/>	<input checked="" type="checkbox"/>	<input checked="" type="checkbox"/>
7	Flash	Flash		1	<input checked="" type="checkbox"/>	<input checked="" type="checkbox"/>	<input checked="" type="checkbox"/>	<input checked="" type="checkbox"/>	<input checked="" type="checkbox"/>
8	Sprecode	Sprecode	*60	1	<input checked="" type="checkbox"/>	<input checked="" type="checkbox"/>	<input checked="" type="checkbox"/>	<input checked="" type="checkbox"/>	<input checked="" type="checkbox"/>
9	Park	John	*700	1	<input checked="" type="checkbox"/>	<input checked="" type="checkbox"/>	<input checked="" type="checkbox"/>	<input checked="" type="checkbox"/>	<input checked="" type="checkbox"/>
10	Pickup	James	*700	1	<input checked="" type="checkbox"/>	<input checked="" type="checkbox"/>	<input checked="" type="checkbox"/>	<input checked="" type="checkbox"/>	<input checked="" type="checkbox"/>
11	Last Call Return			1	<input checked="" type="checkbox"/>	<input checked="" type="checkbox"/>	<input checked="" type="checkbox"/>	<input checked="" type="checkbox"/>	<input checked="" type="checkbox"/>
12	Directory	Dir		1	<input checked="" type="checkbox"/>	<input checked="" type="checkbox"/>	<input checked="" type="checkbox"/>	<input checked="" type="checkbox"/>	<input checked="" type="checkbox"/>
13	Callers List	Callers List		1	<input checked="" type="checkbox"/>	<input checked="" type="checkbox"/>	<input checked="" type="checkbox"/>	<input checked="" type="checkbox"/>	<input checked="" type="checkbox"/>
14	Intercom	Intercom		1	<input checked="" type="checkbox"/>	<input checked="" type="checkbox"/>	<input checked="" type="checkbox"/>	<input checked="" type="checkbox"/>	<input checked="" type="checkbox"/>
15	Services	Services		1	<input checked="" type="checkbox"/>	<input checked="" type="checkbox"/>	<input checked="" type="checkbox"/>	<input checked="" type="checkbox"/>	<input checked="" type="checkbox"/>
16	Empty			1	<input checked="" type="checkbox"/>	<input checked="" type="checkbox"/>	<input checked="" type="checkbox"/>	<input checked="" type="checkbox"/>	<input checked="" type="checkbox"/>
17	None			1	<input checked="" type="checkbox"/>	<input checked="" type="checkbox"/>	<input checked="" type="checkbox"/>	<input checked="" type="checkbox"/>	<input checked="" type="checkbox"/>
18	None			1	<input checked="" type="checkbox"/>	<input checked="" type="checkbox"/>	<input checked="" type="checkbox"/>	<input checked="" type="checkbox"/>	<input checked="" type="checkbox"/>
19	None			1	<input checked="" type="checkbox"/>	<input checked="" type="checkbox"/>	<input checked="" type="checkbox"/>	<input checked="" type="checkbox"/>	<input checked="" type="checkbox"/>
20	None			1	<input checked="" type="checkbox"/>	<input checked="" type="checkbox"/>	<input checked="" type="checkbox"/>	<input checked="" type="checkbox"/>	<input checked="" type="checkbox"/>

Services

XML Application URI:

XML Application Title:

BLF List URI:

Key	Type	Value	Line
1	Services		global
2	Directory		1
3	Callers List		1
4	Intercom		global
5	None		1
6	None		1

Services

BLF List URI:

2. For softkeys, select from **"Key 1"** through **"Key 20"**.
or
For programmable keys, select from **"Key 1"** through **"Key 6"**.
3. In the **"Type"** field, select **Park**.

4. In the "**Label**" field, enter a label for the Park softkey.
5. In the "**Value**" field, enter the appropriate value based on the server in your network.
Note: For values to enter in this field, see the table "[Park/Pickup Call Server Configuration Values](#)" on [page 54](#).
6. In the "**Line**" field, select a line for which to apply the Park configuration.
7. If configuring a softkey on the Bottom Keys, in the state fields, check (enable) or uncheck (disable) the "**Connected**" state to apply to this softkey.
8. Pick another softkey (from top or bottom keys) to configure for Picking up a call.
9. In the "**Label**" field, enter a label for the Pickup softkey.
10. In the "**Value**" field, enter the appropriate value based on the server in your network.
Note: For values to enter in this field, see the table "[Park/Pickup Call Server Configuration Values](#)" on [page 54](#).
11. In the "**Line**" field, select a line for which to apply the Pickup configuration.
12. If configuring a softkey on the Bottom Keys, in the state fields, check (enable) or uncheck (disable) the "**Idle**" and "**Outgoing**" states to apply to this softkey.
13. Click to save your changes.
14. Click on **Operation->Reset**.
15. In the "**Restart Phone**" field click to restart the IP phone.

Using the Park Call/Pickup Parked Call Feature

Use the following procedure on the IP phones to park a call and pick up a parked call.

Park a Call

1. While on a live call, press the "**Park**" softkey.
2. Perform the following for your specific server:

For Asterisk Server
- Server announces the extension number where the call has been parked. Once the call is parked, press the  key to complete parking.
For BroadWorks Server
- After you hear the greeting from the CallPark server, enter the extension where you want to park the call.
For Synatro Server
- Enter the extension number where you want to park the call, followed by "#" key.
For ININ Server
- Enter the extension number where you want to park the call, followed by "#" key.

If the call is parked successfully, the response is either a greeting voice confirming that the call was parked, or a hang up occurs. The parked call party will get music on hold.

3. If the call fails, you can pick up the call (using the next procedure) and press the "**Park**" softkey again to retry step 2.

Pickup a Parked Call

1. Pick up the handset on the phone.
2. Enter the extension number where the call was parked.
3. Press the "**Pickup**" softkey.

If the call pick up is successful, you are connected with the parked call.

Softkeys as Last Call Return (lcr) (Sylantro Servers only)

Using the Aastra Web UI, you can configure the "Last call return" (lcr) function on a softkey. This feature is for Sylantro servers only.

How it works

If you configure "lcr" on a softkey, and a call comes into your phone, after you are finished with the call and hangup, you can press the key configured for "lcr" and the phone dials the last call you received. When you configure an "lcr" softkey, the label "LCR" displays next to that softkey on the IP phone. When the Sylantro server detects an "lcr" request, it translates this request and routes the call to the last caller.

Setting a Last Call Return Softkey



Aastra Web UI

Use the following procedure to configure a Last Call Return softkey on the 55i phone.

1. Click on **Operation->Softkeys and XML.**
or
Click on **Operation->Programmable Keys.**

Status

System Information

Operation

User Password

Phone Lock

Softkeys and XML

Programmable Keys

Directory

Reset

Basic Settings

Preferences

Call Forward

Softkeys Configuration

Key	Type	Label	Value	Line	Idle	Connected	Incoming	Outgoing	Busy
1	Line	L1		5	<input checked="" type="checkbox"/>	<input checked="" type="checkbox"/>	<input checked="" type="checkbox"/>	<input checked="" type="checkbox"/>	<input checked="" type="checkbox"/>
2	Speeddial	Home	5555555	1	<input checked="" type="checkbox"/>	<input checked="" type="checkbox"/>	<input checked="" type="checkbox"/>	<input checked="" type="checkbox"/>	<input checked="" type="checkbox"/>
3	Do Not Disturb			1	<input checked="" type="checkbox"/>	<input checked="" type="checkbox"/>	<input checked="" type="checkbox"/>	<input checked="" type="checkbox"/>	<input checked="" type="checkbox"/>
4	BLF	BLF	3333333	1	<input checked="" type="checkbox"/>	<input checked="" type="checkbox"/>	<input checked="" type="checkbox"/>	<input checked="" type="checkbox"/>	<input checked="" type="checkbox"/>
5	BLF/List			1	<input checked="" type="checkbox"/>	<input checked="" type="checkbox"/>	<input checked="" type="checkbox"/>	<input checked="" type="checkbox"/>	<input checked="" type="checkbox"/>
6	XML	Stocks	http://stocks.com	1	<input checked="" type="checkbox"/>	<input checked="" type="checkbox"/>	<input checked="" type="checkbox"/>	<input checked="" type="checkbox"/>	<input checked="" type="checkbox"/>
7	Flash	Flash		1	<input checked="" type="checkbox"/>	<input checked="" type="checkbox"/>	<input checked="" type="checkbox"/>	<input checked="" type="checkbox"/>	<input checked="" type="checkbox"/>
8	Spreecode	Spreecode	*80	1	<input checked="" type="checkbox"/>	<input checked="" type="checkbox"/>	<input checked="" type="checkbox"/>	<input checked="" type="checkbox"/>	<input checked="" type="checkbox"/>
9	Park	John	*700	1	<input checked="" type="checkbox"/>	<input checked="" type="checkbox"/>	<input checked="" type="checkbox"/>	<input checked="" type="checkbox"/>	<input checked="" type="checkbox"/>
10	Pickup	James	*700	1	<input checked="" type="checkbox"/>	<input checked="" type="checkbox"/>	<input checked="" type="checkbox"/>	<input checked="" type="checkbox"/>	<input checked="" type="checkbox"/>
11	Last Call Return			1	<input checked="" type="checkbox"/>	<input checked="" type="checkbox"/>	<input checked="" type="checkbox"/>	<input checked="" type="checkbox"/>	<input checked="" type="checkbox"/>
12	Directory	Dir		1	<input checked="" type="checkbox"/>	<input checked="" type="checkbox"/>	<input checked="" type="checkbox"/>	<input checked="" type="checkbox"/>	<input checked="" type="checkbox"/>
13	Callers List	Callers List		1	<input checked="" type="checkbox"/>	<input checked="" type="checkbox"/>	<input checked="" type="checkbox"/>	<input checked="" type="checkbox"/>	<input checked="" type="checkbox"/>
14	Intercom	Icom		1	<input checked="" type="checkbox"/>	<input checked="" type="checkbox"/>	<input checked="" type="checkbox"/>	<input checked="" type="checkbox"/>	<input checked="" type="checkbox"/>
15	Services	Services		1	<input checked="" type="checkbox"/>	<input checked="" type="checkbox"/>	<input checked="" type="checkbox"/>	<input checked="" type="checkbox"/>	<input checked="" type="checkbox"/>
16	Empty			1	<input checked="" type="checkbox"/>	<input checked="" type="checkbox"/>	<input checked="" type="checkbox"/>	<input checked="" type="checkbox"/>	<input checked="" type="checkbox"/>
17	None			1	<input checked="" type="checkbox"/>	<input checked="" type="checkbox"/>	<input checked="" type="checkbox"/>	<input checked="" type="checkbox"/>	<input checked="" type="checkbox"/>
18	None			1	<input checked="" type="checkbox"/>	<input checked="" type="checkbox"/>	<input checked="" type="checkbox"/>	<input checked="" type="checkbox"/>	<input checked="" type="checkbox"/>
19	None			1	<input checked="" type="checkbox"/>	<input checked="" type="checkbox"/>	<input checked="" type="checkbox"/>	<input checked="" type="checkbox"/>	<input checked="" type="checkbox"/>
20	None			1	<input checked="" type="checkbox"/>	<input checked="" type="checkbox"/>	<input checked="" type="checkbox"/>	<input checked="" type="checkbox"/>	<input checked="" type="checkbox"/>

Services

XML Application URI:

XML Application Title:

BLF List URI:

Key	Type	Value	Line
1	Services		global
2	Directory		1
3	Callers List		1
4	Intercom		global
5	None		1
6	None		1

Services

BLF List URI:

2. For softkeys, select from "**Key 1**" through "**Key 20**".
or
For programmable keys, select from "**Key 1**" through "**Key 6**".
3. In the "**Type**" field, select **Last Call Return**.
4. In the "**Line**" field, select the line you want to apply to this softkey.
Valid values are 1 through 9.
5. If configuring a softkey on the Bottom Keys, in the state fields, check (enable) or uncheck (disable) the states you want to apply to this softkey.
6. Click to save your changes.
7. Click on **Operation->Reset**.
8. In the "**Restart Phone**" field click to restart the IP phone.

Softkeys as Services

By default, the 55i has a Services key configured on key 1 of the top set of keys. However, you can use any softkey to configure a "Services" key.

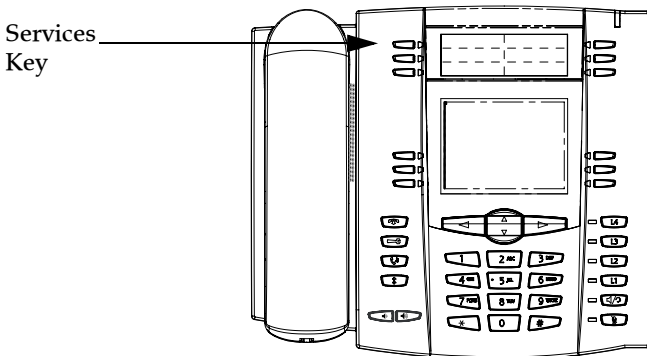

The Services key accesses enhanced features and services provided by third parties. Using the "Services" key, you can:

- Select customized (XML) features
- Utilize a Caller List
- Utilize a Directory
- Utilize Voicemail

Note: Other than the Services Menu, you can also configure the Caller List and Directory List on separate softkeys.

The XML customized services are created and provided by your system administrator through the diverse web based language of XML. Availability of these services depends on your phone system or service provider.

Reference

For more information about XML, Caller List, Directory, and Voicemail, see the following:

- ["Softkeys for Accessing XML Services" on page 44](#)
- ["Callers List" on page 100](#)
- ["Directory List" on page 93](#)
- ["Voicemail" on page 109](#)

For more information about Services you can access on your phone, contact your system administrator.

Use the following procedure to configure a Services softkey on the 55i phone.

Note: Key 1 on the top set of programmable keys is configured for Services by default.

1. Click on **Operation->Softkeys and XML**.
or
Click on **Operation->Programmable Keys**.

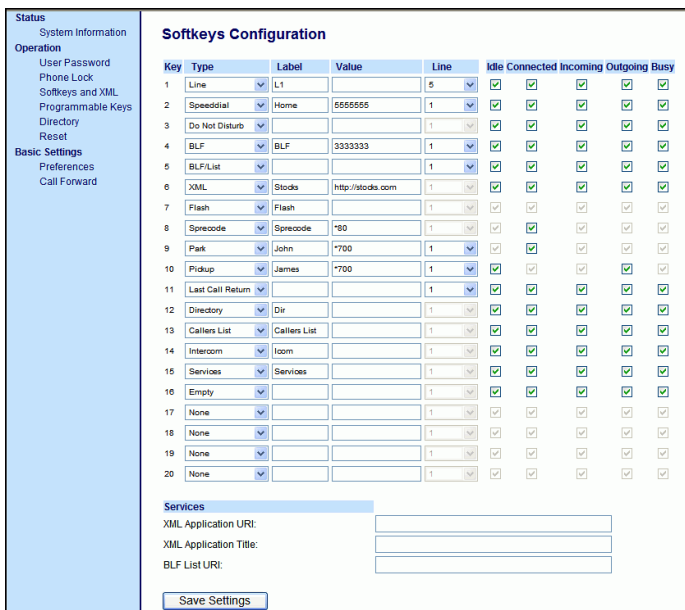

Softkeys Configuration

Key	Type	Label	Value	Line	Idle	Connected	Incoming	Outgoing	Busy
1	Line	L1		5	<input checked="" type="checkbox"/>	<input checked="" type="checkbox"/>	<input checked="" type="checkbox"/>	<input checked="" type="checkbox"/>	<input checked="" type="checkbox"/>
2	Speeddial	Home	5555555	1	<input checked="" type="checkbox"/>	<input checked="" type="checkbox"/>	<input checked="" type="checkbox"/>	<input checked="" type="checkbox"/>	<input checked="" type="checkbox"/>
3	Do Not Disturb			1	<input checked="" type="checkbox"/>	<input checked="" type="checkbox"/>	<input checked="" type="checkbox"/>	<input checked="" type="checkbox"/>	<input checked="" type="checkbox"/>
4	BLF	BLF	3333333	1	<input checked="" type="checkbox"/>	<input checked="" type="checkbox"/>	<input checked="" type="checkbox"/>	<input checked="" type="checkbox"/>	<input checked="" type="checkbox"/>
5	BLF/List			1	<input checked="" type="checkbox"/>	<input checked="" type="checkbox"/>	<input checked="" type="checkbox"/>	<input checked="" type="checkbox"/>	<input checked="" type="checkbox"/>
6	XML	Stoda	http://stode.com	1	<input checked="" type="checkbox"/>	<input checked="" type="checkbox"/>	<input checked="" type="checkbox"/>	<input checked="" type="checkbox"/>	<input checked="" type="checkbox"/>
7	Flash			1	<input checked="" type="checkbox"/>	<input checked="" type="checkbox"/>	<input checked="" type="checkbox"/>	<input checked="" type="checkbox"/>	<input checked="" type="checkbox"/>
8	Sprecode	Sprecode	*80	1	<input checked="" type="checkbox"/>	<input checked="" type="checkbox"/>	<input checked="" type="checkbox"/>	<input checked="" type="checkbox"/>	<input checked="" type="checkbox"/>
9	Park	John	*700	1	<input checked="" type="checkbox"/>	<input checked="" type="checkbox"/>	<input checked="" type="checkbox"/>	<input checked="" type="checkbox"/>	<input checked="" type="checkbox"/>
10	Pickup	James	*700	1	<input checked="" type="checkbox"/>	<input checked="" type="checkbox"/>	<input checked="" type="checkbox"/>	<input checked="" type="checkbox"/>	<input checked="" type="checkbox"/>
11	Last Call Return			1	<input checked="" type="checkbox"/>	<input checked="" type="checkbox"/>	<input checked="" type="checkbox"/>	<input checked="" type="checkbox"/>	<input checked="" type="checkbox"/>
12	Directory	Dir		1	<input checked="" type="checkbox"/>	<input checked="" type="checkbox"/>	<input checked="" type="checkbox"/>	<input checked="" type="checkbox"/>	<input checked="" type="checkbox"/>
13	Callers List	Callers List		1	<input checked="" type="checkbox"/>	<input checked="" type="checkbox"/>	<input checked="" type="checkbox"/>	<input checked="" type="checkbox"/>	<input checked="" type="checkbox"/>
14	Intercom	Icom		1	<input checked="" type="checkbox"/>	<input checked="" type="checkbox"/>	<input checked="" type="checkbox"/>	<input checked="" type="checkbox"/>	<input checked="" type="checkbox"/>
15	Services	Services		1	<input checked="" type="checkbox"/>	<input checked="" type="checkbox"/>	<input checked="" type="checkbox"/>	<input checked="" type="checkbox"/>	<input checked="" type="checkbox"/>
16	Empty			1	<input checked="" type="checkbox"/>	<input checked="" type="checkbox"/>	<input checked="" type="checkbox"/>	<input checked="" type="checkbox"/>	<input checked="" type="checkbox"/>
17	None			1	<input checked="" type="checkbox"/>	<input checked="" type="checkbox"/>	<input checked="" type="checkbox"/>	<input checked="" type="checkbox"/>	<input checked="" type="checkbox"/>
18	None			1	<input checked="" type="checkbox"/>	<input checked="" type="checkbox"/>	<input checked="" type="checkbox"/>	<input checked="" type="checkbox"/>	<input checked="" type="checkbox"/>
19	None			1	<input checked="" type="checkbox"/>	<input checked="" type="checkbox"/>	<input checked="" type="checkbox"/>	<input checked="" type="checkbox"/>	<input checked="" type="checkbox"/>
20	None			1	<input checked="" type="checkbox"/>	<input checked="" type="checkbox"/>	<input checked="" type="checkbox"/>	<input checked="" type="checkbox"/>	<input checked="" type="checkbox"/>

Services

XML Application URI:

XML Application Title:

BLF List URI:

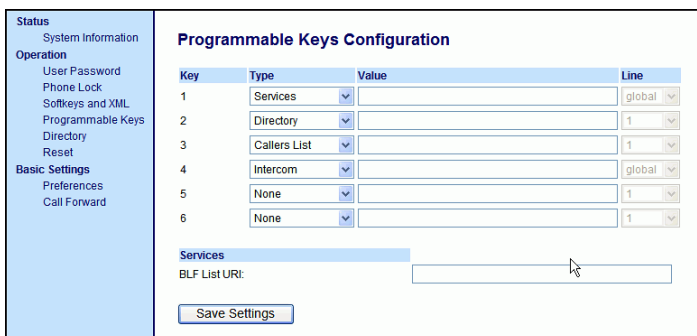

Programmable Keys Configuration

Key	Type	Value	Line
1	Services		global
2	Directory		1
3	Callers List		1
4	Intercom		global
5	None		1
6	None		1

Services

BLF List URI:

2. For softkeys, select from "**Key 1**" through "**Key 20**".
or
For programmable keys, select from "**Key 1**" through "**Key 6**".
3. In the "**Type**" field, select **Services**.
4. In the "**Label**" field, enter a label to apply to this softkey.
5. In the "**Line**" field, select the line you want to apply to this softkey. Valid values are 1 through 9.
6. If configuring a softkey on the Bottom Keys, in the state fields, check (enable) or uncheck (disable) the states you want to apply to this softkey.
7. Click to save your changes.
8. Click on **Operation->Reset**.
9. In the "**Restart Phone**" field click to restart the IP phone.

Softkeys as Directory

By default, the 55i has a Directory key configured on key 2 of the top set of keys. However, using the Aastra Web UI, you can assign the Directory key to any softkey on the top or bottom keys on the phone..

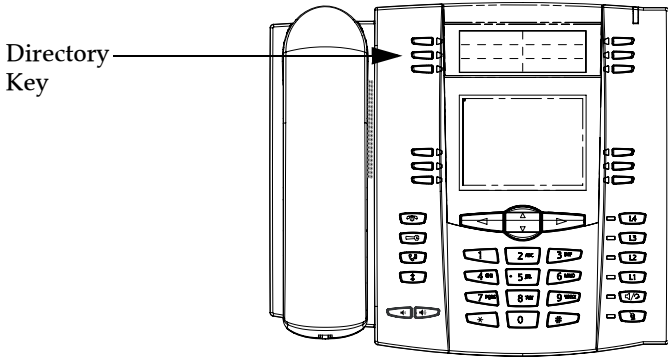

The "Directory List" feature allows you to store frequently used names and numbers on the phone. You can also dial directly from a directory entry. You can use the Directory key to access a Directory List which contains a customized list of names with phone numbers and labels.

In addition to creating a Directory softkey, you can also download a Directory List to your PC if required using the Aastra Web UI.

Reference

For more information about the Directory List, see "[Directory List](#)" on [page 93](#).



Use the following procedure to configure a Directory softkey on the 55i phone.

Note: Key 2 on the top set of programmable keys is set to Directory by default.

1. Click on **Operation->Softkeys and XML.**

or

Click on **Operation->Programmable Keys.**

Status

System Information

Operation

User Password

Phone Lock

Softkeys and XML

Programmable Keys

Directory

Reset

Basic Settings

Preferences

Call Forward

Softkeys Configuration

Key	Type	Label	Value	Line	Idle	Connected	Incoming	Outgoing	Busy
1	Line	L1		5	<input checked="" type="checkbox"/>	<input checked="" type="checkbox"/>	<input checked="" type="checkbox"/>	<input checked="" type="checkbox"/>	<input checked="" type="checkbox"/>
2	Speeddial	Home	5555555	1	<input checked="" type="checkbox"/>	<input checked="" type="checkbox"/>	<input checked="" type="checkbox"/>	<input checked="" type="checkbox"/>	<input checked="" type="checkbox"/>
3	Do Not Disturb			1	<input checked="" type="checkbox"/>	<input checked="" type="checkbox"/>	<input checked="" type="checkbox"/>	<input checked="" type="checkbox"/>	<input checked="" type="checkbox"/>
4	BLF	BLF	3333333	1	<input checked="" type="checkbox"/>	<input checked="" type="checkbox"/>	<input checked="" type="checkbox"/>	<input checked="" type="checkbox"/>	<input checked="" type="checkbox"/>
5	BLF/List			1	<input checked="" type="checkbox"/>	<input checked="" type="checkbox"/>	<input checked="" type="checkbox"/>	<input checked="" type="checkbox"/>	<input checked="" type="checkbox"/>
6	XML	Stocks	http://stocks.com	1	<input checked="" type="checkbox"/>	<input checked="" type="checkbox"/>	<input checked="" type="checkbox"/>	<input checked="" type="checkbox"/>	<input checked="" type="checkbox"/>
7	Flash	Flash		1	<input checked="" type="checkbox"/>	<input checked="" type="checkbox"/>	<input checked="" type="checkbox"/>	<input checked="" type="checkbox"/>	<input checked="" type="checkbox"/>
8	Speedcode	Speedcode	*80	1	<input checked="" type="checkbox"/>	<input checked="" type="checkbox"/>	<input checked="" type="checkbox"/>	<input checked="" type="checkbox"/>	<input checked="" type="checkbox"/>
9	Park	John	*700	1	<input checked="" type="checkbox"/>	<input checked="" type="checkbox"/>	<input checked="" type="checkbox"/>	<input checked="" type="checkbox"/>	<input checked="" type="checkbox"/>
10	Pickup	James	*700	1	<input checked="" type="checkbox"/>	<input checked="" type="checkbox"/>	<input checked="" type="checkbox"/>	<input checked="" type="checkbox"/>	<input checked="" type="checkbox"/>
11	Last Call Return			1	<input checked="" type="checkbox"/>	<input checked="" type="checkbox"/>	<input checked="" type="checkbox"/>	<input checked="" type="checkbox"/>	<input checked="" type="checkbox"/>
12	Directory	Dir		1	<input checked="" type="checkbox"/>	<input checked="" type="checkbox"/>	<input checked="" type="checkbox"/>	<input checked="" type="checkbox"/>	<input checked="" type="checkbox"/>
13	Callers List	Callers List		1	<input checked="" type="checkbox"/>	<input checked="" type="checkbox"/>	<input checked="" type="checkbox"/>	<input checked="" type="checkbox"/>	<input checked="" type="checkbox"/>
14	Intercom	loom		1	<input checked="" type="checkbox"/>	<input checked="" type="checkbox"/>	<input checked="" type="checkbox"/>	<input checked="" type="checkbox"/>	<input checked="" type="checkbox"/>
15	Services	Services		1	<input checked="" type="checkbox"/>	<input checked="" type="checkbox"/>	<input checked="" type="checkbox"/>	<input checked="" type="checkbox"/>	<input checked="" type="checkbox"/>
16	Empty			1	<input checked="" type="checkbox"/>	<input checked="" type="checkbox"/>	<input checked="" type="checkbox"/>	<input checked="" type="checkbox"/>	<input checked="" type="checkbox"/>
17	None			1	<input checked="" type="checkbox"/>	<input checked="" type="checkbox"/>	<input checked="" type="checkbox"/>	<input checked="" type="checkbox"/>	<input checked="" type="checkbox"/>
18	None			1	<input checked="" type="checkbox"/>	<input checked="" type="checkbox"/>	<input checked="" type="checkbox"/>	<input checked="" type="checkbox"/>	<input checked="" type="checkbox"/>
19	None			1	<input checked="" type="checkbox"/>	<input checked="" type="checkbox"/>	<input checked="" type="checkbox"/>	<input checked="" type="checkbox"/>	<input checked="" type="checkbox"/>
20	None			1	<input checked="" type="checkbox"/>	<input checked="" type="checkbox"/>	<input checked="" type="checkbox"/>	<input checked="" type="checkbox"/>	<input checked="" type="checkbox"/>

Services

XML Application URI:

XML Application Title:

BLF List URI:

Status

System Information

Operation

User Password

Phone Lock

Softkeys and XML

Programmable Keys

Directory

Reset

Basic Settings

Preferences

Call Forward

Programmable Keys Configuration

Key	Type	Value	Line
1	Services		global
2	Directory		1
3	Callers List		1
4	Intercom		global
5	None		1
6	None		1

Services

BLF List URI:

2. For softkeys, select from **"Key 1"** through **"Key 20"**.

or

For programmable keys, select from "**Key 1**" through "**Key 6**".

3. In the "**Type**" field, select **Directory**.
4. In the "**Label**" field, enter a label to apply to this softkey.
5. If configuring a softkey on the Bottom Keys, in the state fields, check (enable) or uncheck (disable) the states you want to apply to this softkey.
6. Click to save your changes.
7. Click on **Operation->Reset**.
8. In the "**Restart Phone**" field click to restart the IP phone.

Softkeys as Callers List

By default, the 55i has a Callers List key configured on key 3 of the top set of keys. However, using the Aastra Web UI, you can assign the Callers List key to any softkey on the top or bottom keys on the phone.

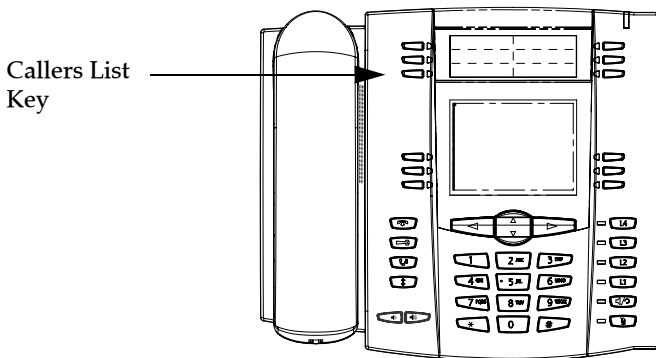

The Callers list is a stored log of your incoming calls. You can use the Callers List key to access a list of callers that called your phone.

Reference

For more information about the Callers List, see "[Suppressing DTMF Playback](#)" on [page 110](#).

Use the following procedure to configure a Callers List softkey on the 55i phone.

Note: Key 3 on the top set of programmable keys is set to Callers List by default.

1. Click on **Operation->Softkeys and XML**.

or

Click on **Operation->Programmable Keys**.

Key	Type	Label	Value	Line	Idle	Connected	Incoming	Outgoing	Busy
1	Line	L1		5	<input checked="" type="checkbox"/>	<input checked="" type="checkbox"/>	<input checked="" type="checkbox"/>	<input checked="" type="checkbox"/>	<input checked="" type="checkbox"/>
2	Speeddial	Home	5555555	1	<input checked="" type="checkbox"/>	<input checked="" type="checkbox"/>	<input checked="" type="checkbox"/>	<input checked="" type="checkbox"/>	<input checked="" type="checkbox"/>
3	Do Not Disturb			1	<input checked="" type="checkbox"/>	<input checked="" type="checkbox"/>	<input checked="" type="checkbox"/>	<input checked="" type="checkbox"/>	<input checked="" type="checkbox"/>
4	BLF	BLF	3333333	1	<input checked="" type="checkbox"/>	<input checked="" type="checkbox"/>	<input checked="" type="checkbox"/>	<input checked="" type="checkbox"/>	<input checked="" type="checkbox"/>
5	BLF/List			1	<input checked="" type="checkbox"/>	<input checked="" type="checkbox"/>	<input checked="" type="checkbox"/>	<input checked="" type="checkbox"/>	<input checked="" type="checkbox"/>
6	XML	Stodis	http://stodis.com	1	<input checked="" type="checkbox"/>	<input checked="" type="checkbox"/>	<input checked="" type="checkbox"/>	<input checked="" type="checkbox"/>	<input checked="" type="checkbox"/>
7	Flash	Flash		1	<input checked="" type="checkbox"/>	<input checked="" type="checkbox"/>	<input checked="" type="checkbox"/>	<input checked="" type="checkbox"/>	<input checked="" type="checkbox"/>
8	Sprecode	Sprecode	*60	1	<input checked="" type="checkbox"/>	<input checked="" type="checkbox"/>	<input checked="" type="checkbox"/>	<input checked="" type="checkbox"/>	<input checked="" type="checkbox"/>
9	Park	John	*700	1	<input checked="" type="checkbox"/>	<input checked="" type="checkbox"/>	<input checked="" type="checkbox"/>	<input checked="" type="checkbox"/>	<input checked="" type="checkbox"/>
10	Pickup	James	*700	1	<input checked="" type="checkbox"/>	<input checked="" type="checkbox"/>	<input checked="" type="checkbox"/>	<input checked="" type="checkbox"/>	<input checked="" type="checkbox"/>
11	Last Call Return			1	<input checked="" type="checkbox"/>	<input checked="" type="checkbox"/>	<input checked="" type="checkbox"/>	<input checked="" type="checkbox"/>	<input checked="" type="checkbox"/>
12	Directory	Dir		1	<input checked="" type="checkbox"/>	<input checked="" type="checkbox"/>	<input checked="" type="checkbox"/>	<input checked="" type="checkbox"/>	<input checked="" type="checkbox"/>
13	Callers List	Callers List		1	<input checked="" type="checkbox"/>	<input checked="" type="checkbox"/>	<input checked="" type="checkbox"/>	<input checked="" type="checkbox"/>	<input checked="" type="checkbox"/>
14	Intercom	Room		1	<input checked="" type="checkbox"/>	<input checked="" type="checkbox"/>	<input checked="" type="checkbox"/>	<input checked="" type="checkbox"/>	<input checked="" type="checkbox"/>
15	Services	Services		1	<input checked="" type="checkbox"/>	<input checked="" type="checkbox"/>	<input checked="" type="checkbox"/>	<input checked="" type="checkbox"/>	<input checked="" type="checkbox"/>
16	Empty			1	<input checked="" type="checkbox"/>	<input checked="" type="checkbox"/>	<input checked="" type="checkbox"/>	<input checked="" type="checkbox"/>	<input checked="" type="checkbox"/>
17	None			1	<input checked="" type="checkbox"/>	<input checked="" type="checkbox"/>	<input checked="" type="checkbox"/>	<input checked="" type="checkbox"/>	<input checked="" type="checkbox"/>
18	None			1	<input checked="" type="checkbox"/>	<input checked="" type="checkbox"/>	<input checked="" type="checkbox"/>	<input checked="" type="checkbox"/>	<input checked="" type="checkbox"/>
19	None			1	<input checked="" type="checkbox"/>	<input checked="" type="checkbox"/>	<input checked="" type="checkbox"/>	<input checked="" type="checkbox"/>	<input checked="" type="checkbox"/>
20	None			1	<input checked="" type="checkbox"/>	<input checked="" type="checkbox"/>	<input checked="" type="checkbox"/>	<input checked="" type="checkbox"/>	<input checked="" type="checkbox"/>

Services

XML Application URI:

XML Application Title:

BLF List URI:

Key	Type	Value	Line
1	Services		global
2	Directory		1
3	Callers List		1
4	Intercom		global
5	None		1
6	None		1

Services



BLF List URI:

2. For softkeys, select from **"Key 1"** through **"Key 20"**.

or

For programmable keys, select from **"Key 1"** through **"Key 6"**.

3. In the **"Type"** field, select **Callers List**.

4. In the "**Label**" field, enter a label to apply to this softkey.
5. If configuring a softkey on the Bottom Keys, in the state fields, check (enable) or uncheck (disable) the states you want to apply to this softkey.
6. Click  to save your changes.
7. Click on **Operation->Reset**.
8. In the "**Restart Phone**" field click  to restart the IP phone.

Softkeys as an Intercom Key

By default, the 55i has an Intercom key configured on key 4 of the top set of keys. However, using the Aastra Web UI, you can assign the Intercom key to any softkey on the top or bottom keys on the phone..

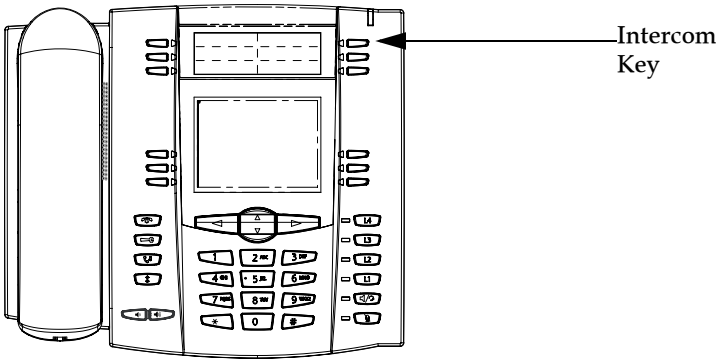

You can use the Intercom key to automatically connect with a remote extension for outgoing calls, and to answer an incoming intercom call.

Reference

For more information about the Intercom key, see "[Intercom](#)" on [page 82](#).



Use the following procedure to configure an Intercom softkey on the 55i phone.

Note: Key 4 on the top set of programmable keys is set to Intercom by default.

1. Click on **Operation->Softkeys and XML**.

or

Click on **Operation->Programmable Keys**.

Status		Softkeys Configuration										
System Information		Key	Type	Label	Value	Line	Idle	Connected	Incoming	Outgoing	Busy	
Operation		1	Line	L1		8	<input checked="" type="checkbox"/>	<input checked="" type="checkbox"/>	<input checked="" type="checkbox"/>	<input checked="" type="checkbox"/>	<input checked="" type="checkbox"/>	
User Password		2	Speedial	Home	6666666	1	<input checked="" type="checkbox"/>	<input checked="" type="checkbox"/>	<input checked="" type="checkbox"/>	<input checked="" type="checkbox"/>	<input checked="" type="checkbox"/>	
Phone Lock		3	Do Not Disturb			1	<input checked="" type="checkbox"/>	<input checked="" type="checkbox"/>	<input checked="" type="checkbox"/>	<input checked="" type="checkbox"/>	<input checked="" type="checkbox"/>	
Softkeys and XML		4	BLF	BLF	3333333	1	<input checked="" type="checkbox"/>	<input checked="" type="checkbox"/>	<input checked="" type="checkbox"/>	<input checked="" type="checkbox"/>	<input checked="" type="checkbox"/>	
Programmable Keys		5	BLF/List			1	<input checked="" type="checkbox"/>	<input checked="" type="checkbox"/>	<input checked="" type="checkbox"/>	<input checked="" type="checkbox"/>	<input checked="" type="checkbox"/>	
Directory		6	XML	Stocks	http://stocks.com	1	<input checked="" type="checkbox"/>	<input checked="" type="checkbox"/>	<input checked="" type="checkbox"/>	<input checked="" type="checkbox"/>	<input checked="" type="checkbox"/>	
Reset		7	Flash	Flash		1	<input checked="" type="checkbox"/>	<input checked="" type="checkbox"/>	<input checked="" type="checkbox"/>	<input checked="" type="checkbox"/>	<input checked="" type="checkbox"/>	
Basic Settings		8	Sprecode	Sprecode	*80	1	<input checked="" type="checkbox"/>	<input checked="" type="checkbox"/>	<input checked="" type="checkbox"/>	<input checked="" type="checkbox"/>	<input checked="" type="checkbox"/>	
Preferences		9	Park	John	*700	1	<input checked="" type="checkbox"/>	<input checked="" type="checkbox"/>	<input checked="" type="checkbox"/>	<input checked="" type="checkbox"/>	<input checked="" type="checkbox"/>	
Call Forward		10	Pickup	James	*700	1	<input checked="" type="checkbox"/>	<input checked="" type="checkbox"/>	<input checked="" type="checkbox"/>	<input checked="" type="checkbox"/>	<input checked="" type="checkbox"/>	
		11	Last Call Return			1	<input checked="" type="checkbox"/>	<input checked="" type="checkbox"/>	<input checked="" type="checkbox"/>	<input checked="" type="checkbox"/>	<input checked="" type="checkbox"/>	
		12	Directory	Dir		1	<input checked="" type="checkbox"/>	<input checked="" type="checkbox"/>	<input checked="" type="checkbox"/>	<input checked="" type="checkbox"/>	<input checked="" type="checkbox"/>	
		13	Callers List	Callers List		1	<input checked="" type="checkbox"/>	<input checked="" type="checkbox"/>	<input checked="" type="checkbox"/>	<input checked="" type="checkbox"/>	<input checked="" type="checkbox"/>	
		14	Intercom	loom		1	<input checked="" type="checkbox"/>	<input checked="" type="checkbox"/>	<input checked="" type="checkbox"/>	<input checked="" type="checkbox"/>	<input checked="" type="checkbox"/>	
		15	Services	Services		1	<input checked="" type="checkbox"/>	<input checked="" type="checkbox"/>	<input checked="" type="checkbox"/>	<input checked="" type="checkbox"/>	<input checked="" type="checkbox"/>	
		16	Empty			1	<input checked="" type="checkbox"/>	<input checked="" type="checkbox"/>	<input checked="" type="checkbox"/>	<input checked="" type="checkbox"/>	<input checked="" type="checkbox"/>	
		17	None			1	<input checked="" type="checkbox"/>	<input checked="" type="checkbox"/>	<input checked="" type="checkbox"/>	<input checked="" type="checkbox"/>	<input checked="" type="checkbox"/>	
		18	None			1	<input checked="" type="checkbox"/>	<input checked="" type="checkbox"/>	<input checked="" type="checkbox"/>	<input checked="" type="checkbox"/>	<input checked="" type="checkbox"/>	
		19	None			1	<input checked="" type="checkbox"/>	<input checked="" type="checkbox"/>	<input checked="" type="checkbox"/>	<input checked="" type="checkbox"/>	<input checked="" type="checkbox"/>	
		20	None			1	<input checked="" type="checkbox"/>	<input checked="" type="checkbox"/>	<input checked="" type="checkbox"/>	<input checked="" type="checkbox"/>	<input checked="" type="checkbox"/>	
		Services										
		XML Application URI: <input type="text"/>										
		XML Application Title: <input type="text"/>										
		BLF List URI: <input type="text"/>										
		<input type="button" value="Save Settings"/>										

Status		Programmable Keys Configuration			
System Information		Key	Type	Value	Line
Operation		1	Services		global
User Password		2	Directory		1
Phone Lock		3	Callers List		1
Softkeys and XML		4	Intercom		global
Programmable Keys		5	None		1
Directory		6	None		1
Reset					
Basic Settings					
Preferences					
Call Forward					
		Services			
		BLF List URI: <input type="text"/>			
		<input type="button" value="Save Settings"/>			

2. For softkeys, select from **"Key 1"** through **"Key 20"**.

or

For programmable keys, select from **"Key 1"** through **"Key 6"**.

3. In the "**Type**" field, select **Intercom**.
4. In the "**Label**" field, enter a label to apply to this softkey.
5. If configuring a softkey on the Bottom Keys, in the state fields, check (enable) or uncheck (disable) the states you want to apply to this softkey.
6. Click to save your changes.
7. Click on **Operation->Reset**.
8. In the "**Restart Phone**" field click to restart the IP phone.

Softkeys as an Empty Key

You can set a softkey to force a blank entry on the IP phone display for a specific softkey. You do this by setting the softkey to "**empty**". The soft keys are added in order (from softkey1 to softkey20) after any hard-coded keys have been added. If a particular soft key is not defined, it is ignored.

Setting an EmptySoftkey



Aastra Web UI

Use the following procedure to configure an Empty softkey on the 55i phone.

1. Click on **Operation->Softkeys and XML**.

or

- Click on **Operation->Programmable Keys**.

Key	Type	Label	Value	Line	Idle	Connected	Incoming	Outgoing	Busy
1	Line	L1		5	<input checked="" type="checkbox"/>	<input checked="" type="checkbox"/>	<input checked="" type="checkbox"/>	<input checked="" type="checkbox"/>	<input checked="" type="checkbox"/>
2	Speeddial	Home	5555555	1	<input checked="" type="checkbox"/>	<input checked="" type="checkbox"/>	<input checked="" type="checkbox"/>	<input checked="" type="checkbox"/>	<input checked="" type="checkbox"/>
3	Do Not Disturb			1	<input checked="" type="checkbox"/>	<input checked="" type="checkbox"/>	<input checked="" type="checkbox"/>	<input checked="" type="checkbox"/>	<input checked="" type="checkbox"/>
4	BLF	BLF	3333333	1	<input checked="" type="checkbox"/>	<input checked="" type="checkbox"/>	<input checked="" type="checkbox"/>	<input checked="" type="checkbox"/>	<input checked="" type="checkbox"/>
5	BLFList			1	<input checked="" type="checkbox"/>	<input checked="" type="checkbox"/>	<input checked="" type="checkbox"/>	<input checked="" type="checkbox"/>	<input checked="" type="checkbox"/>
6	XML	Stocks	http://stocks.com	1	<input checked="" type="checkbox"/>	<input checked="" type="checkbox"/>	<input checked="" type="checkbox"/>	<input checked="" type="checkbox"/>	<input checked="" type="checkbox"/>
7	Flash	Flash		1	<input checked="" type="checkbox"/>	<input checked="" type="checkbox"/>	<input checked="" type="checkbox"/>	<input checked="" type="checkbox"/>	<input checked="" type="checkbox"/>
8	Sprecode	Sprecode	*90	1	<input checked="" type="checkbox"/>	<input checked="" type="checkbox"/>	<input checked="" type="checkbox"/>	<input checked="" type="checkbox"/>	<input checked="" type="checkbox"/>
9	Park	John	*700	1	<input checked="" type="checkbox"/>	<input checked="" type="checkbox"/>	<input checked="" type="checkbox"/>	<input checked="" type="checkbox"/>	<input checked="" type="checkbox"/>
10	Pickup	James	*700	1	<input checked="" type="checkbox"/>	<input checked="" type="checkbox"/>	<input checked="" type="checkbox"/>	<input checked="" type="checkbox"/>	<input checked="" type="checkbox"/>
11	Last Call Return			1	<input checked="" type="checkbox"/>	<input checked="" type="checkbox"/>	<input checked="" type="checkbox"/>	<input checked="" type="checkbox"/>	<input checked="" type="checkbox"/>
12	Directory	Dir		1	<input checked="" type="checkbox"/>	<input checked="" type="checkbox"/>	<input checked="" type="checkbox"/>	<input checked="" type="checkbox"/>	<input checked="" type="checkbox"/>
13	Callers List	Callers List		1	<input checked="" type="checkbox"/>	<input checked="" type="checkbox"/>	<input checked="" type="checkbox"/>	<input checked="" type="checkbox"/>	<input checked="" type="checkbox"/>
14	Intercom	toom		1	<input checked="" type="checkbox"/>	<input checked="" type="checkbox"/>	<input checked="" type="checkbox"/>	<input checked="" type="checkbox"/>	<input checked="" type="checkbox"/>
15	Services	Services		1	<input checked="" type="checkbox"/>	<input checked="" type="checkbox"/>	<input checked="" type="checkbox"/>	<input checked="" type="checkbox"/>	<input checked="" type="checkbox"/>
16	Empty			1	<input checked="" type="checkbox"/>	<input checked="" type="checkbox"/>	<input checked="" type="checkbox"/>	<input checked="" type="checkbox"/>	<input checked="" type="checkbox"/>
17	None			1	<input checked="" type="checkbox"/>	<input checked="" type="checkbox"/>	<input checked="" type="checkbox"/>	<input checked="" type="checkbox"/>	<input checked="" type="checkbox"/>
18	None			1	<input checked="" type="checkbox"/>	<input checked="" type="checkbox"/>	<input checked="" type="checkbox"/>	<input checked="" type="checkbox"/>	<input checked="" type="checkbox"/>
19	None			1	<input checked="" type="checkbox"/>	<input checked="" type="checkbox"/>	<input checked="" type="checkbox"/>	<input checked="" type="checkbox"/>	<input checked="" type="checkbox"/>
20	None			1	<input checked="" type="checkbox"/>	<input checked="" type="checkbox"/>	<input checked="" type="checkbox"/>	<input checked="" type="checkbox"/>	<input checked="" type="checkbox"/>

Services

XML Application URI:

XML Application Title:

BLF List URI:

Key	Type	Value	Line
1	Services		global
2	Directory		1
3	Callers List		1
4	Intercom		global
5	None		1
6	None		1

Services

BLF List URI:

2. For softkeys, select from "**Key 1**" through "**Key 20**".
or
For programmable keys, select from "**Key 1**" through "**Key 6**".
3. In the "**Type**" field, select **Empty**.
4. If configuring a softkey on the Bottom Keys, in the state fields, check (enable) or uncheck (disable) the states you want to apply to this softkey.
5. Click to save your changes.
6. Click on **Operation->Reset**.
7. In the "**Restart Phone**" field click to restart the IP phone.

Deleting a Softkey



Use the following procedure to delete a softkey function using the Aastra Web UI.

1. Click on **Operation->Softkeys and XML**.

or

1. Click on **Operation->Programmable Keys**.

Status
System Information

Operation
User Password
Phone Lock
Softkeys and XML
Programmable Keys
Directory
Reset
Basic Settings
Preferences
Call Forward

Softkeys Configuration

Key	Type	Label	Value	Line	Idle	Connected	Incoming	Outgoing	Busy
1	Line	L1		5	<input checked="" type="checkbox"/>	<input checked="" type="checkbox"/>	<input checked="" type="checkbox"/>	<input checked="" type="checkbox"/>	<input checked="" type="checkbox"/>
2	Speedial	Home	5555555	1	<input checked="" type="checkbox"/>	<input checked="" type="checkbox"/>	<input checked="" type="checkbox"/>	<input checked="" type="checkbox"/>	<input checked="" type="checkbox"/>
3	Do Not Disturb			1	<input checked="" type="checkbox"/>	<input checked="" type="checkbox"/>	<input checked="" type="checkbox"/>	<input checked="" type="checkbox"/>	<input checked="" type="checkbox"/>
4	BLF	BLF	3333333	1	<input checked="" type="checkbox"/>	<input checked="" type="checkbox"/>	<input checked="" type="checkbox"/>	<input checked="" type="checkbox"/>	<input checked="" type="checkbox"/>
5	BLF/List			1	<input checked="" type="checkbox"/>	<input checked="" type="checkbox"/>	<input checked="" type="checkbox"/>	<input checked="" type="checkbox"/>	<input checked="" type="checkbox"/>
6	XML	Stoks	http://stods.com	1	<input checked="" type="checkbox"/>	<input checked="" type="checkbox"/>	<input checked="" type="checkbox"/>	<input checked="" type="checkbox"/>	<input checked="" type="checkbox"/>
7	Flash	Flash		1	<input checked="" type="checkbox"/>	<input checked="" type="checkbox"/>	<input checked="" type="checkbox"/>	<input checked="" type="checkbox"/>	<input checked="" type="checkbox"/>
8	Sperecode	Sperecode	*80	1	<input checked="" type="checkbox"/>	<input checked="" type="checkbox"/>	<input checked="" type="checkbox"/>	<input checked="" type="checkbox"/>	<input checked="" type="checkbox"/>
9	Park	John	*700	1	<input checked="" type="checkbox"/>	<input checked="" type="checkbox"/>	<input checked="" type="checkbox"/>	<input checked="" type="checkbox"/>	<input checked="" type="checkbox"/>
10	Pickup	James	*700	1	<input checked="" type="checkbox"/>	<input checked="" type="checkbox"/>	<input checked="" type="checkbox"/>	<input checked="" type="checkbox"/>	<input checked="" type="checkbox"/>
11	Last Call Return			1	<input checked="" type="checkbox"/>	<input checked="" type="checkbox"/>	<input checked="" type="checkbox"/>	<input checked="" type="checkbox"/>	<input checked="" type="checkbox"/>
12	Directory	Dir		1	<input checked="" type="checkbox"/>	<input checked="" type="checkbox"/>	<input checked="" type="checkbox"/>	<input checked="" type="checkbox"/>	<input checked="" type="checkbox"/>
13	Callers List	Callers List		1	<input checked="" type="checkbox"/>	<input checked="" type="checkbox"/>	<input checked="" type="checkbox"/>	<input checked="" type="checkbox"/>	<input checked="" type="checkbox"/>
14	Intercom	Izom		1	<input checked="" type="checkbox"/>	<input checked="" type="checkbox"/>	<input checked="" type="checkbox"/>	<input checked="" type="checkbox"/>	<input checked="" type="checkbox"/>
15	Services	Services		1	<input checked="" type="checkbox"/>	<input checked="" type="checkbox"/>	<input checked="" type="checkbox"/>	<input checked="" type="checkbox"/>	<input checked="" type="checkbox"/>
16	Empty			1	<input checked="" type="checkbox"/>	<input checked="" type="checkbox"/>	<input checked="" type="checkbox"/>	<input checked="" type="checkbox"/>	<input checked="" type="checkbox"/>
17	None			1	<input checked="" type="checkbox"/>	<input checked="" type="checkbox"/>	<input checked="" type="checkbox"/>	<input checked="" type="checkbox"/>	<input checked="" type="checkbox"/>
18	None			1	<input checked="" type="checkbox"/>	<input checked="" type="checkbox"/>	<input checked="" type="checkbox"/>	<input checked="" type="checkbox"/>	<input checked="" type="checkbox"/>
19	None			1	<input checked="" type="checkbox"/>	<input checked="" type="checkbox"/>	<input checked="" type="checkbox"/>	<input checked="" type="checkbox"/>	<input checked="" type="checkbox"/>
20	None			1	<input checked="" type="checkbox"/>	<input checked="" type="checkbox"/>	<input checked="" type="checkbox"/>	<input checked="" type="checkbox"/>	<input checked="" type="checkbox"/>

Services
XML Application URI:
XML Application Title:
BLF List URI:

Status
System Information

Operation
User Password
Phone Lock
Softkeys and XML
Programmable Keys
Directory
Reset
Basic Settings
Preferences
Call Forward

Programmable Keys Configuration



Key	Type	Value	Line
1	Services		global
2	Directory		1
3	Callers List		1
4	Intercom		global
5	None		1
6	None		1

Services
BLF List URI:

2. For softkeys, select from **"Key 1"** through **"Key 20"**.

or

- For programmable keys, select from **"Key 1"** through **"Key 6"**.



3. In the "**Type**" field, select **none**.
4. Click  to save your changes.
5. Click on **Operation->Reset**.
6. In the "**Restart Phone**" field click  to restart the IP phone.
The softkey function is deleted from the IP phone memory.

Restarting your phone

You may want to restart your phone to check for updates on the server. You may occasionally need to restart your phone to set changes or updates to your phone or network settings. You may also need to restart your phone if you have been asked to do so by your system administrator, or should you experience any unexpected behaviour.



IP Phone UI

1. Press the  button on the phone to enter the Options List.
2. Use the  key to scroll down the list of options to **Phone Status** and press **Show** to select.
3. Press the  key to scroll to the **Restart Phone** option.
4. Press **Show** to select the **Restart Phone** option.
5. Press **Restart** to restart of the phone. If you do not wish to restart your phone, press **Cancel**.

Note: Your phone will be out of service temporarily during the restart and downloading process.



Aastra Web UI

1. Click on **Operation->Reset**.

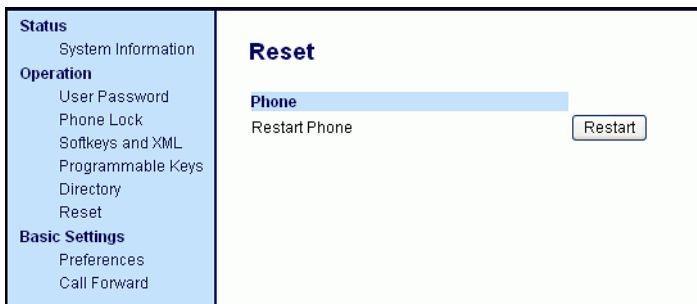

2. Click .
3. Click **OK** at the confirmation prompt.

Making Calls

Dialing a Number

First, take the phone off-hook by:

- lifting the handset
- pressing  or
- pressing a line/call appearance button.

At the dial tone, enter the number you wish to call. If you are unable to make calls within certain area codes, check with your system administrator for any toll restrictions placed on your extension that may restrict your access to long distance area codes or dialling prefixes.

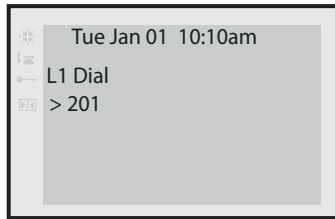

When your party picks up, a timer appears on your display that records the length of your call.

If the Live DialPad option is on, as soon as you press the first digit on the dial pad the phone will automatically select the next available line, go off-hook and dial as digits are pressed.

Pre-dialing a Number

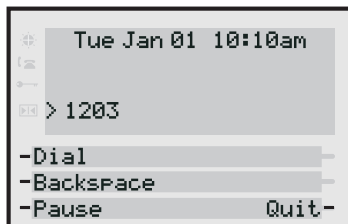

You can also make a call by pre-dialling a number. Pre-dialling lets you view a number before you dial. Use the **Backspace** softkey to correct any errors.

Using Handsfree Speakerphone

The handsfree feature allows you to speak to someone without using the handset or headset. Your phone must be in either the Speaker or Speaker/Headset audio mode. You can set your desired audio mode using the **Headset Settings** option from the Options list. For more information, see the section "**Customizing Your Phone**" in the *55i Installation Guide*.



IP Phone UI

- To dial using handsfree, first press and enter a number at the dial tone.
- If in speaker audio mode, press to switch between handsfree and handset.
- If in speaker/headset audio mode, press to switch between handsfree and headset.
- When the handset is on hook, press to disconnect a handsfree call.

When handsfree is on, the speaker light turns on.

Using a Headset

The 55i accepts headsets through the modular RJ22 jack on the back of the phone. Contact your telephone equipment retailer or distributor to purchase a compatible headset.

Note: Customers should read and observe all safety recommendations contained in headset operating guides when using any headset.

Advanced Volume Controls for the Headset Mic

On the 55i, there are 3 options for the headset microphone volume.



IP Phone UI

To change this volume

1. Press to enter the Options list.
2. Use to scroll down the list of options to **Headset Settings** and press **Show**.
or
3. Press the list number to jump directly to this option, and press **Show**.
4. Press to scroll down to **headset/mic volume** and press **Show**.
5. Use to scroll down the list and press **Show** to select your desired volume.



6. Press **Done** to save changes and exit.
7. If you do not wish to save changes, press **Cancel** to return to the previous screen.

NOTE: By default, the volume for the headset microphone is set to medium.

To Make and Receive Calls Using a Headset



IP Phone UI

1. Ensure that you have selected a headset audio mode by accessing the Options list (under option **Headset Settings**).
2. Plug the headset into the jack.
3. Press the  key to obtain a dial tone or to answer an incoming call. Depending on the audio mode selected from the Options menu, a dial tone or an incoming call will be received on either the headset or the handsfree speakerphone.
4. Press the  to end the call.

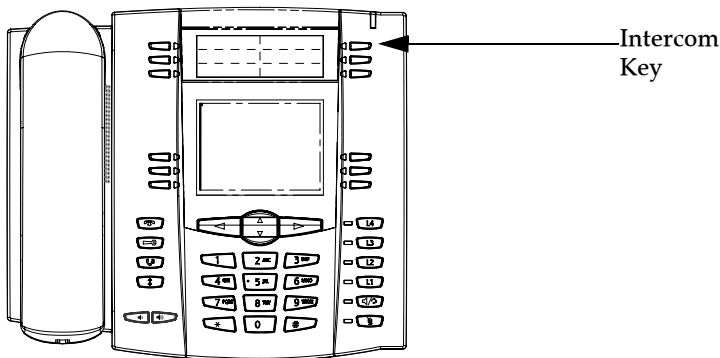

Intercom

On the 55i, you can use the **Intercom** key to automatically connect with a remote extension. By default, the Intercom key is configured as Key 4 on the top set of softkeys.



IP Phone UI

To use the Intercom key

1. Press the **Intercom** key.
2. Enter the extension number of the person you wish to intercom or the BLF softkey for that extension.
3. After a beep tone, your phone will automatically connect with the remote extension and you can speak through its speaker.
4. To cancel intercom, press  or the **Cancel** softkey.
5. When you are finished speaking, hang up the phone by placing the handset back on-hook or by pressing  or the line/call appearance button for the active call. When you hang up, the remote phone will also hang up.

Incoming Intercom Calls

On the 55i, you can receive incoming intercom calls. By default, the microphone for an incoming intercom call is OFF, and the automatic answer for an intercom call is ON.

Using the Aastra Web UI, you can enable (turn ON) or disable (turn OFF) the microphone or automatic answering (auto-answer) on the IP phone for incoming intercom calls. If auto-answer is enabled on the IP phone, the phone plays a tone to alert the user before answering the intercom call. If auto-answer is disabled, the phone rejects the incoming intercom call and sends a busy signal to the caller.

Use the following procedure to enable/disable the microphone and/or auto-answer on the IP phone.

1. Click on **Basic Settings->Preferences->Incoming Intercom Settings**.

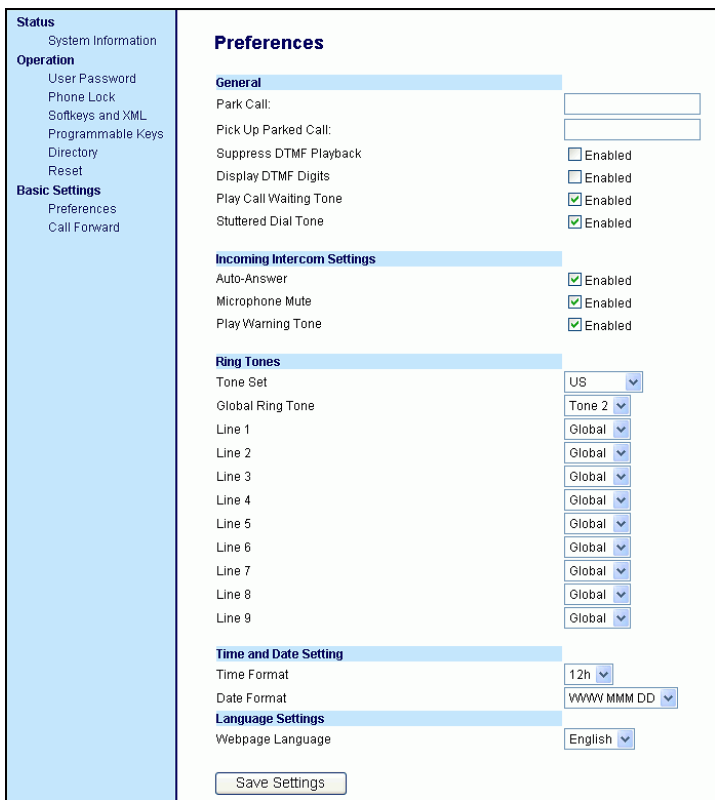

Status
System Information

Operation
User Password
Phone Lock
Softkeys and XML
Programmable Keys
Directory
Reset

Basic Settings
Preferences
Call Forward

Preferences

General
Park Call:
Pick Up Parked Call:
Suppress DTMF Playback: Enabled
Display DTMF Digits: Enabled
Play Call Waiting Tone: Enabled
Sluttered Dial Tone: Enabled

Incoming Intercom Settings
Auto-Answer: Enabled
Microphone Mute: Enabled
Play Warning Tone: Enabled

Ring Tones
Tone Set: US
Global Ring Tone: Tone 2
Line 1: Global
Line 2: Global
Line 3: Global
Line 4: Global
Line 5: Global
Line 6: Global
Line 7: Global
Line 8: Global
Line 9: Global

Time and Date Setting
Time Format: 12h
Date Format: WWW MMM DD

Language Settings
Webpage Language: English

The "**Microphone Mute**" field is enabled by default (turned OFF).

The "**Auto-Answer**" field is enabled by default (turned ON).

2. To disable the "**Microphone Mute**" field (turn ON), uncheck the check box.
 3. To disable the "**Auto-Answer**" field (turn OFF), uncheck the check box.
 4. Click to save your changes.
 5. Click on **Operation->Reset**.
 6. In the "**Restart Phone**" field click to restart the IP phone.
- Refer to the following procedure for using the Intercom feature.

Redial



IP Phone UI

- Press to dial the most recent number you dialed from the phone.
- If you are off-hook and press the last number you called will be called back.
- If you are on-hook and press , a **Redial Directory** list appears on-screen.

The redial list stores up to the last 100 numbers you called, allowing you to scroll through and select the number you wish to redial.

Note: Your system administrator can set your Redial key to speedial a specific number. Contact your system administrator for more information.

Accessing the Redial List



IP Phone UI

1. If you are off-hook and press , the telephone automatically dials the last number you called.
2. If you are not on the phone, press to display the most recently dialed number and use to scroll through the list to view the other numbers
3. Press to see the second most recently dialed number, or to see the oldest call on your list.
4. To dial the displayed number press , or lift the Handset or press any line keys.
5. Press or the key to cancel.

Deleting from the Redial List

Note: You cannot delete individual entries in the Redial List.



IP Phone UI



To Delete All Items

1. Press .
2. Press the **Delete** Key, then press the **Delete** Key again at the prompt to erase all items.

Mute



IP Phone UI

Press the  button at any time to mute handset, headset or handsfree. The speaker light will flash slowly and you can hear the caller, but they cannot hear you. To switch mute on or off, press .

Note: If you place a muted call on hold, the phone automatically takes the call off mute when you reconnect to the call.

Receiving Calls

When a call is ringing at your extension, you will see the "**Inbound Call**" Screen. The line/call appearance light flashes quickly for the incoming call.

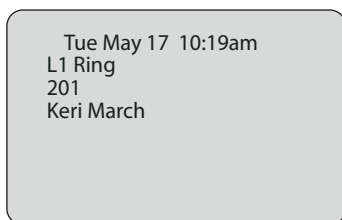

Answering an Incoming Call



IP Phone UI

To answer the call

- For handsfree operation, press  or the line/call appearance button for the incoming call.
- Press  for handsfree or headset operation.

Note: The audio mode setting you have selected in the options list under **Headset Settings** determines if the call goes to handsfree or headset operation. For more information, see the section "**Customizing Your Phone**" in the *53i Installation Guide*.



- Lift the handset for handset operation.

If the phone is already connected to a call, pressing the line/call appearance button for the new incoming call automatically places the connected call on hold and answers the new call. To reconnect to a party, press the line/call appearance button for that call.

If you cannot answer the call, the caller goes to voicemail if voicemail has been configured for your extension.

Note: The  button can be used to cancel the call pickup procedure.

Sending an Incoming Call to Voicemail

You can send an incoming call directly to voicemail without answering the call. To do this, press  without picking up the handset. If you're already on the phone your incoming call should go directly to voicemail. Your phone screen displays a voicemail icon () along with the number of waiting messages, if you have unheard messages (example:  ×4).

Note:

Handling Calls

When you are connected to a call, you can use the softkeys or hard keys on the phone to transfer, conference, or place a call on hold.

Placing a Call on Hold

When you place a call on hold, only your phone can retrieve the call.



IP Phone UI

To place a call on hold

1. Connect to the call (if not already connected).
2. Press the Hold  key.

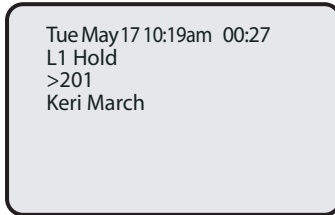

The line/call appearance light will begin to flash slowly and after a short time the phone will beep softly to remind you that you still have a call on hold. The screen displays "**Call Held**" with the line number the call is held at the phone.

Note: The phone will not beep to remind you that you still have a call on hold if you are connected to another call.

When on Hold

To let your caller know that they are still on hold, music plays softly (if this has been set up for your system). The call/line appearance light for the line you are on remains solid to indicate that you are still connected.

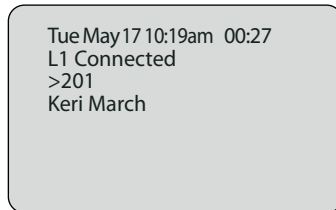

Automatic Hold

When juggling between calls, you do not have to press the hold button to go from one call to the next. The phone automatically puts your current call on hold as soon as you press a new line/call appearance button. If you have more than one call on hold, you can reconnect to a held call by pressing the line/call appearance button where that call is being held. Press  to disconnect the call.

Retrieving a Held Call

If you have more than 1 call on hold, you can scroll through the held call information by pressing ◀ and ▶ navigation keys. To reconnect to a call press the line/call appearance button where that call is being held. If you press the call/line appearance button again, you will disconnect from the call.

Transferring Calls

Blind Transfer

A blind transfer is when you transfer a call directly to another extension without consulting with the person receiving the call. To do this, simply complete the transfer immediately after you have entered the number. The call goes directly to the extension or outside line you transferred to. If the party you are transferring the call to does not answer, the transferred call rings back to your extension.

Consultative Transfer

You also have the option to consult with the person you are transferring the call to, before you complete the transfer. To do this, simply remain on the line until the receiving party answers the call. After consulting with the receiving party, you can either complete the transfer or cancel the transfer to go back to the original call.



IP Phone UI

When you lift the handset on the phone, the **Transfer** key displays on the bottom set of softkeys by default. Use this key to transfer calls.



Screen that displays when handset is lifted

Use the following procedure to transfer a call to another extension. Use the following illustration as a reference.

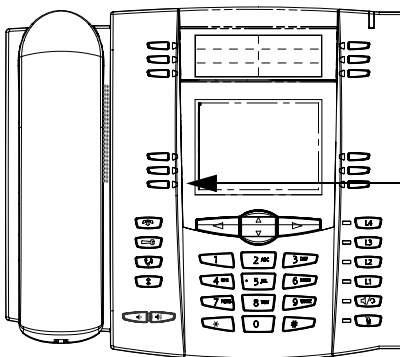

Transfer
Key when handset is
lifted

To transfer a call to another extension

1. Connect to the call you wish to transfer (if not already connected).
2. Press the **Transfer** key.

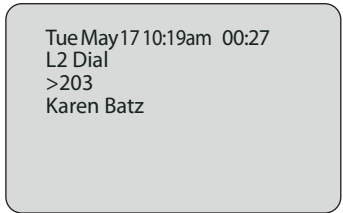

3. Press a line/call appearance button followed by the extension number of the person you wish to transfer the call to.
4. If you do not wish to transfer the call, press the line/call appearance button again to abort the transfer. This disconnects the new call, leaving the original call on hold. To go back to the original call, press the line/call appearance button for this call.
5. To complete the transfer, you can press the **Transfer** key again, or disconnect by placing the handset back on hook, pressing  or pressing the line/call appearance button for the active call.

Note: To complete a "blind" transfer, press the **Transfer** Key again before the phone begins dialing. To complete a consultive transfer, remain on the line to speak with the party, before pressing the **Transfer** Key again. To cancel the transfer, select **Cancel** on the display screen.

Conferencing Calls

The 55i phone system supports up to 3 parties (including yourself) in a conference call.

Note: Your system administrator can set your conference key to speedial a specific number. Contact your system administrator for more information.

When you lift the handset on the phone, the **Conference** key displays on the bottom set of softkeys by default. Use this key to create conference calls.



Screen that displays when handset is lifted



Use the following procedure to create a conference call. Use the following illustration as a reference.

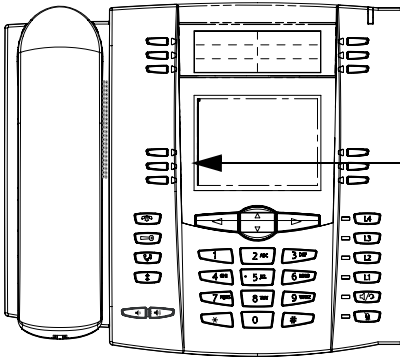

Conference key when handset is lifted

1. Connect to the first party you wish to include in the conference (if not already connected).

Note: A "Conference" softkey automatically appears in the display when on a call.

2. Press the **Conference** key. A new line opens.

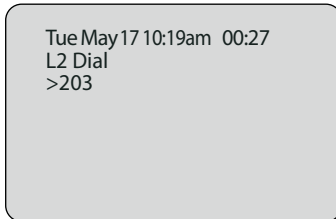

3. Press a line/call appearance button followed by the extension number of the person you wish to add to the conference.

4. Wait for the new party to answer. You can consult with the new party first before adding them to the conference.

5. If you do not wish to add the new party to the conference, press the line/call appearance button for this call. This disconnects the new party, leaving the original call on hold. To go back to the original call, press the line/call appearance button for this call.

6. To add the new party to the conference, press the **Conference** key again.

7. To drop the new party from the conference, press the **Conference** key one more time.

Note: You can use to scroll through and see the numbers and names (if available) of the parties in the conference call.

8.If you wish to exit the conference leaving the other two parties connected, disconnect by placing the handset back on-hook or by pressing  .

To conference two calls you are already connected to



IP Phone UI

1. Begin with active calls on two different lines.
2. Press the **Conference** key. A new line will open.
3. Press the line key of the call you wish to conference with.
4. Press the **Conference** key again. The two lines link into a conference call.

NOTE: When a name is displayed, pressing  drops the displayed party from the call.

Note: When a name is displayed, pressing  drops the displayed party from the call.

Picking up Calls

Press the line/call appearance button for an incoming call. If the phone is connected to a call, pressing one of the line/call appearance buttons will automatically place this call on hold before opening up a new line for the new call.



IP Phone UI

To pickup a call

1. Press the line/call appearance button for that call.

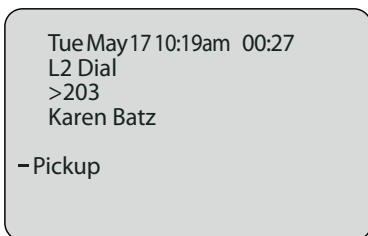

2. Press  if you do not wish to pickup a call. This cancels the call pickup procedure.

Managing Calls

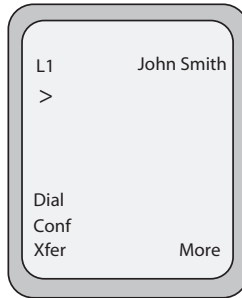

The 55i has several features that make it easier to manage calls, and to keep track of your caller history, as well as your business and personal contacts. These features include:

- **Directory List**
- **Callers List**
- **Call Forwarding**
- **Missed Calls Indicator**
- **Voicemail**

Directory List

The 55i IP phone has a "**Directory List**" feature that allows you to store frequently used numbers on the phone. You can also dial directly from a directory entry.

From the Directory List in the IP Phone UI, you can add, delete, change, or move entries as required. The following is an example of the Directory List Header screen with 97 entries in the List.

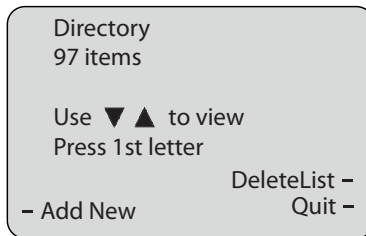

Sorting Entries and Quick Search Feature

You can also sort multiple numbers according to preference and perform a quick-search feature that allows you to enter the first letter that corresponds to a name in the Directory to find specific line items. The phone displays the first name with this letter. The quick-search feature in the Directory List works only when the Directory is first accessed.

Note: The quick-search feature in the Directory List works only when the Directory is first accessed.

Adding to and Editing the Directory List

You can store a maximum of 7 numbers associated with a unique name. You can apply pre-defined labels to the entry which include, Office, Home, Cell, and Pager, or create your own labels. The following table indicates the maximum characters for each line and field in the Directory List.

Directory List Limitations	
Maximum length of a line	255 characters
Maximum length of a name	16 characters
Maximum length of a label	14 characters
Maximum length of a URI	45 characters
Maximum number directory entries in the NVRAM	200 entries

The following examples illustrate the IP Phone UI screens you can use to add/edit entries in the Directory List.

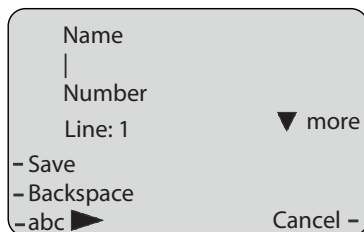

Screen 1

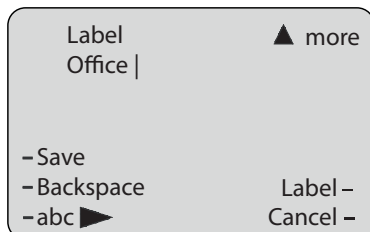



Screen 2

Adding Names, Numbers, Labels

On Screen 1:

- You can add names using the **abc** softkey.
- You can add numbers (up to 7 numbers per name) using the numbers on the phone's keypad.
- Use the **Backspace** softkey when required.
- Use the **Save** softkey when you are finished adding the name and number(s).
- You can exit from Screen 1 at any time without saving by pressing the **Cancel** softkey.

Note: Use the   keys to toggle between Screen 1 and Screen 2.

On Screen 2:

- You can add a label or URI using the **abc** softkey; Or you can populate the "Label" field with a pre-defined label (Office, Home, Cell, Pager) by pressing the **Label** softkey.
- Use the **Backspace** softkey when required.
- Use the **Save** softkey when you are finished adding the Label.
- You can exit from Screen 2 at any time without saving by pressing the **Cancel** softkey.

Editing Names, Numbers, and Labels

On Screen 1, when the cursor is in the "Line" field, softkey 5 displays a **Change** softkey. The following example illustrates a Directory entry for "Steve Smith", with a phone number and an "Office" label. Since the cursor is in the "Line" field, the **Change** softkey displays.



The following example shows the same Directory entry without a label.

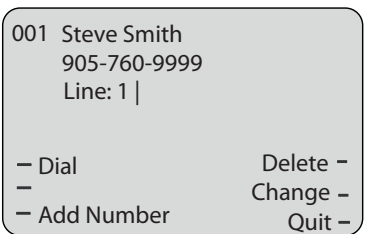

- You can use the **Dial** softkey to automatically dial the number in the Directory entry.
- You can use the **Add Number** softkey to add additional numbers to the current Directory entry (up to 7 numbers per name).

- You can use the **Delete** softkey to delete a number or to delete multiple numbers in an entry (see "[Deleting Single and Multiple Numbers in an Entry](#)" on [page 98](#)).
- You can use the **Change** softkey to change a number or a name.
- You can use the **Quit** softkey to quit the editing of the current Directory entry.

Scrolling Multiple Screens Per Entry

If there are multiple numbers for an entry, the ◀ and ▶ keys display for you to scroll multiple screens. The following examples show **Screen 1** as Steve Smith's Office number, **Screen 2** as Steve Smith's Home number, and **Screen 3** as Steve Smith's Cell number. The first scroll ▶ indicates there are multiple number entries for the name. The ◀ ▶ indicates you can scroll forward or backward between screens. The ◀ indicates this is the last number entry for the name.

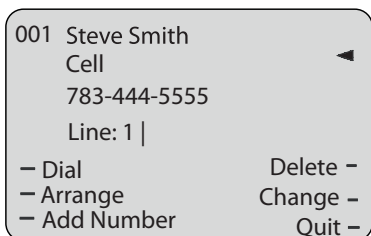
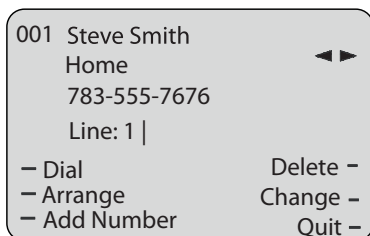
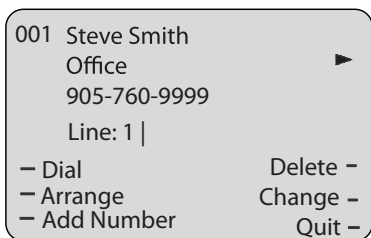

Arranging Multiple Screens

You can use the **Arrange** softkey to move the number/label/line forward or backward between screens for the specified name. If there is a label assigned to the entry, the following screen displays after pressing the **Arrange** softkey.

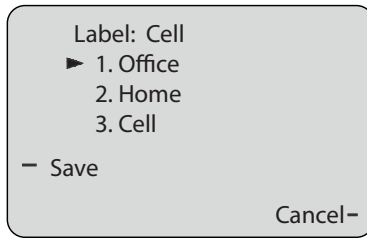

- Pressing the **Save** softkey in the above screen places the Cell label, the Cell number, and line associated with the Cell number, into the one position. So the first screen to display for the entry would be the Cell number screen. If no label is assigned to the entry, the numbers would be arranged in the order you specify.

The following example illustrates the new arrangement of Steve Smith's numbers.

Note: The Office label moves to the second position and the Home label moves to the last position.

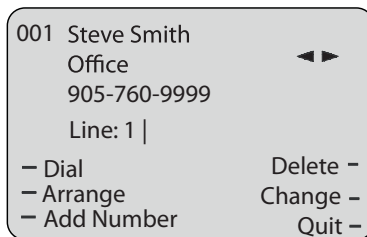
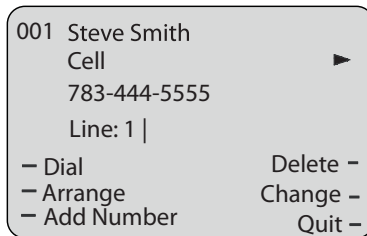

Deleting Single and Multiple Numbers in an Entry

You use the Delete softkey to delete a single number or multiple numbers for an entry. For a single number assigned to a name, pressing the **Delete** softkey displays the following screen.

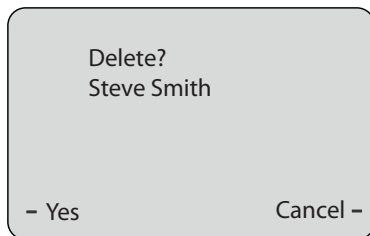

- You can press **Yes** to delete the directory entry (name, number, label, and line) from the Directory List.
- You can press **Cancel** to cancel the delete function.

For multiple numbers assigned to a name, pressing the **Delete** softkey displays the following screen.

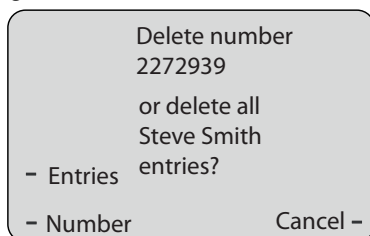

- You can press **Entries** to delete the directory entry (name, all numbers, labels, and lines associated with the name) from the Directory List.
- You can press **Number** to delete only a specific number associated with a name.
- You can press **Cancel** to cancel the delete function.

Downloading the Directory List to Your PC

You can download the Directory List to your PC via the Aastra Web UI. The phone stores the **directorylist.csv** file to your PC in comma-separated value (CSV) format.

You can use any spreadsheet application to open the file for viewing. The following is an example of a Directory List in a spreadsheet application.

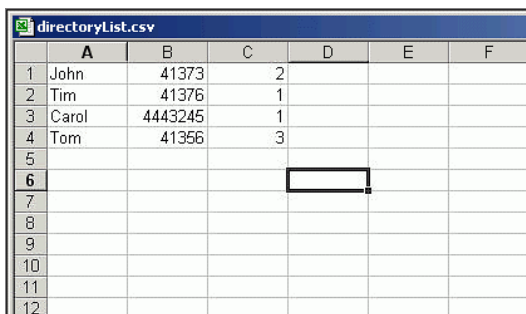

	A	B	C	D	E	F
1	John	41373	2			
2	Tim	41376	1			
3	Carol	4443245	1			
4	Tom	41356	3			
5						
6						
7						
8						
9						
10						
11						
12						

The file displays the name, phone number, and line number for each Directory entry.

Server to IP Phone Download



Your system administrator can populate your IP phone Directory List with server directory files. Contact your system administrator for more details.

Accessing the Directory List

Use the following procedures to access the Directory List.



IP Phone UI

1. Press the **Services** key on the phone to display the **Services** menu, and select "**Directory List**".
or
Press the **Directory** softkey (default key is key 2 on the Top Keys).
2. Use the   keys to scroll through the line items in the Directory List.
3. To dial a displayed entry from the Directory List, pick up the handset, press the  handsfree key, or press the **Dial** softkey.
4. To exit the Directory List, press the **Quit** softkey.

Callers List





The Callers list is a stored log of your incoming calls. The 55i telephone stores information on up to 200 incoming calls in the Callers list. Your telephone logs the number and name (if available) of the caller, when they last called, and the number of times they tried to reach you.

When the Callers list is full, the oldest call records are deleted to accommodate the information of new callers.

If the telephone number of an incoming or outgoing call matches a number that you have programmed with a name in a programmable key or the Directory, the Callers list will display the name and number.

The display shows you how many callers have been added to the list since you last checked it.

Caller's List Screen Display

Display Item	Description
450-349-0438	Indicates you have returned the call from the Callers list.
N MAR 04 3:30pm 2x	"N" indicates a new call.
XX New Callers	When you're not on the telephone and not in the Callers list, the display shows you how many callers have been added to the list since you last checked it.
	Indicates an unanswered call in the Callers list.
	Indicates an answered call in the Callers list.
	Indicates a Call Waiting call in the Callers list.
	Indicates an incoming Call Waiting call.
John Burns 9054550055 Jun 8 2:41pm 2X	"2x" indicates this caller has called twice. The display shows the date and time of the last call from that caller.

You can view, scroll, and delete line items in the Callers List from the IP phone UI. You can also directly dial from a displayed line item in the Callers List.

You can also download the Callers List to your PC for viewing using the Aastra Web UI. When you download the Callers List, the phone stores the **callerlist.csv** file to your computer in comma-separated value (CSV) format.

You can use any spreadsheet application to open the file for viewing. The following is an example of a Callers List in a spreadsheet application. This file displays the name, phone number, and the line that the call came in on.

	A	B	C	D	E	F
1	John	41373		2		
2	Tim	41376		1		
3	Carol	4443245		1		
4	Tom	41356		3		
5						
6						
7						
8						
9						
10						
11						
12						

Using the Callers List



IP Phone UI

Use the following procedure to access the Callers List. Use the following illustration as a reference.

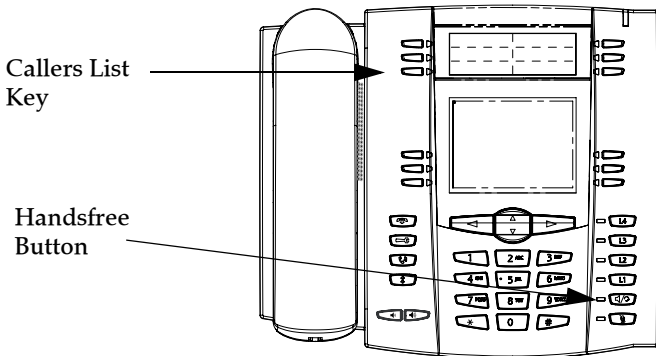

1. Press the **Callers List** key.
or
Press the **Services** key if your system administrator has configured the Services key to access the Callers List.
2. Use the **Up** **Down** keys to scroll through the line items in the Callers List.

Note: To the left of a line item, a icon displays with the handset ON or OFF the receiver. The ON receiver indicates the call came in as a missed call. The OFF receiver indicates the call came in and was answered.

3. To delete all entries in the Callers list, press the **Delete** softkey at the "Callers List" header.

To delete a line item from the Callers List, select the line item you want to delete and press the **Delete** softkey.

4. To cancel a delete function, press the **Up** or the **Down** **Scroll** keys.

- To save a line item to a softkey for speeddialing, press the **Save** softkey and enter the line number at the "Save to?" prompt that is already configured for speeddialing at a softkey.
- To dial a displayed entry from the Callers List, pick up the handset, press the  handsfree button, or press a line key.
- To exit the Callers List, press the **Callers List** key.

Editing in the Callers List

Important: The Caller List does not save changes. Editing in the Callers List is generally used if you plan to call the number and need to add a prefix.

In the Callers List, if a dial pad key is pressed when a number and/or a name is displayed, the cursor will automatically add the digit at the left side of the number to enable the entry of the prefix.

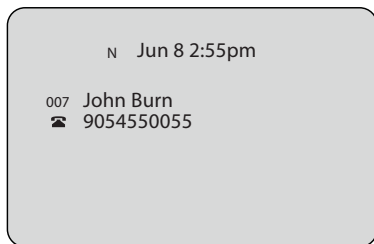

IP Phone UI

Use the following procedure to edit the Callers List. Use the following illustration as a reference.

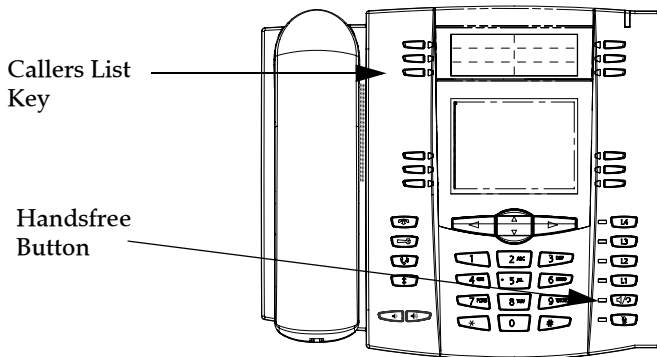

- Press the **Callers List** Key.

2. Press to find the entry you want to edit. Press to view the most recent call, or to see the oldest call on your list.
3. Press any key on the dial pad to begin editing.
4. To move the cursor one digit to the right, press . To erase one digit to the left of the cursor, press .
5. To dial the displayed number press , or just lift the handset, or press any line keys.

Deleting from the Callers List

You can delete individual items from the Callers List, or you can delete all items in the Callers List..



IP Phone UI

Use the following procedure to delete an individual item from the Callers List. Use the following illustration as a reference.

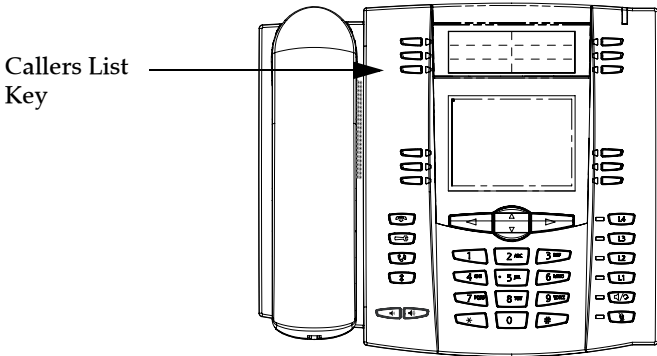

1. Press the **Callers List** Key.
2. Use keys to find the item you want to delete.
3. Press the **Delete** softkey.
4. Press the **Delete** softkey again at the prompt to erase the item.



IP Phone UI

Use the following procedure to delete all items from the Callers List.

1. Press the **Callers List** Key.
2. Press the **Delete** softkey.
3. Press the **Delete** softkey again at the prompt to erase all items.

Downloading the Callers List

Use the following procedure to download the Callers List to your PC using the Aastra Web UI.



Aastra Web UI

1. Click on **Operation->Directory**.

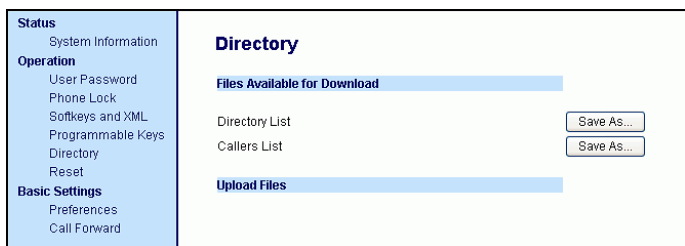

2. In the Callers List field, click on **Save As...**.
A File Download message displays.
3. Click **OK**.
4. Enter the location on your computer where you want to download the Callers List and click **SAVE**.
The *callerslist.csv* file downloads to your computer.
5. Use a spreadsheet application to open and view the Callers List.

Call Forwarding

The call forwarding feature on the IP phone allows incoming calls to be forwarded to another destination. The phone sends the SIP message to the SIP proxy, which then forwards the call to the assigned destination.

Call forwarding is disabled by default. You can enable call forwarding on a global basis or on an individual line-basis, for each line. If you have configured call forwarding on an individual line, then the settings for this line are used; otherwise, the phone-wide call forward settings are used.

You can enable call forwarding on all phones (global settings) or on specific lines (local settings) of a single phone. For local settings, you can set call forwarding on up to 9 individual lines.

For global and local call forwarding, you can set the following:

- **Call forward mode**
- **Destination number**
- **Number of rings before forwarding the call** (from 1 to 9 rings)

The following are the call forward modes you can set:

Call ForwardMode	Description
Off (Aastra Web UI only)	Disables call forward
All	Phone forwards all incoming calls immediately to the specified destination.
Busy	Phone forwards incoming calls if the line is already in use.
No Answer	Phone forwards the call if it is not answered in the specified number of rings
Busy No Answer	Phone forwards the call if either the line is already in use or the call is not answered in the specified number of rings.

Note: You can set the global call forward settings using the IP phone UI or the Aastra Web UI. However, you must use the Aastra Web UI to set the per-line call forward settings. The per-line settings override the settings for global call forwarding.

Setting Call Forwarding

Use the following procedure to set global call forwarding.

For Global Call Forward Settings



IP Phone UI

1. Press  on the phone to enter the Options List.
2. Select **Call Forward** and press **Show**.
3. Enter the "**Call Forward**" number destination for which you want your incoming calls to be forwarded.
Note: If you leave the "Number" field blank, call forwarding is disabled.
4. Enter the "**Call Mode**" that you want to set on your phone.
5. Enter the "**Number of Rings**" you want to set before the call is forwarded. Valid values are 1 to 9.
Note: "Number of Rings" field applies to **No Answer** and **Busy No Answer** modes only.
6. Press **Enter** to save the settings.



Aastra Web UI

1. Click on **Basic Settings->Call Forward**.

Local Line	Mode	Forward Number	Number of Rings
Line 1	Global		1
Line 2	Global		1
Line 3	Global		1
Line 4	Global		1
Line 5	Global		1
Line 6	Global		1
Line 7	Global		1
Line 8	Global		1
Line 9	Global		1

For Global Call Forward Settings:

2. In the "**Mode**" field, select the mode you want to set on your phone.
Note: To disable call forwarding in the Aastra Web UI, set the mode to **OFF** and remove the phone number in the "**Number**" field.
3. In the "**Number**" field, enter the call forward number for which you want your calls to be call forwarded.

4. In the "**Number of Rings**" field, enter the number of rings you want to set before the call is forwarded. Valid values are 1 to 9.
5. Click to save the Call Forward settings. The changes are dynamic and are immediately applied to the phone.

For Per-Line Call Forward Settings:

1. Select a line to set Call Forwarding on.
2. In the "**Mode**" field, select the mode you want to set on this line.
Note: To disable call forwarding in the Aastra Web UI, set the mode to **OFF** and remove the phone number in the "**Forward Number**" field.
Note: To force a line to use the global settings, set the "**Mode**" field to **Global**.
3. In the "**Forward Number**" field, enter the call forward number for which you want your calls on this line to be call forwarded.
4. In the "**Number of Rings**" field, select the number of rings on the line before the call is forwarded. Valid values are 1 to 9.
5. Click to save the Call Forward settings. The changes are dynamic and are immediately applied to the phone.

Missed Calls Indicator

The IP phone has a "missed calls" indicator that increments the number of missed calls to the phone. This feature is accessible from the IP phone UI only.

The number of calls that have not been answered increment on the phone's idle screen as "**<number> New Calls**". As the number of unanswered calls increment, the phone numbers associated with the calls are stored in the Callers List. The user can access the Callers List and clear the call from the list. Once the user accesses the Callers List, the "**<number> New Calls**" on the idle screen is cleared.



Accessing and Clearing Missed Calls.

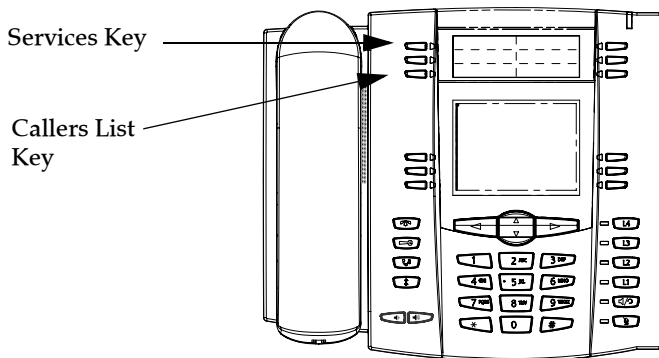

IP Phone UI

Use the following procedure to access and clear missed calls from the Callers List. Once you display the Callers List, the "**<number> New Calls**" indicator clears. Use the following illustration as a reference.



1. Press **Callers List** key on the phone.
or
Press the **Services** key and select **Callers List** from the menu.
2. Use the   keys to scroll through the line items in the Callers List to find the line items that have the  icon with the receiver ON. These are the missed calls to the phone.
3. To clear a line item from the Callers List, select the line item you want to delete and press the **Clear** softkey.

The line item is deleted from the Callers List.

Voicemail

The Voicemail feature on the 55i IP phone allows you to use a line, configured with a phone number for dialing out, to connect to a voicemail server.

For each assigned Voicemail number, there can be a minimum of 0 or a maximum of 1 Voicemail access phone number.

The Voicemail list displays a list of phone numbers assigned to the 55i that have registered voicemail accounts associated with them.

Note: The Voicemail list does not display the voicemail access number.

The phone displays up to 99 voicemails for an account even if the number of voicemails exceeds the limit.

Registered account numbers/URIs that exceed the length of the screen, either with or without the voicemail icon and the message count, are truncated with an ellipse character at the end of the number/URI string.





The end of the Voicemail list displays the number of new voicemail messages (if any exist).

Contact your system administrator for lines configured for Voicemail.

Using Voicemail



IP Phone UI

1. Press the **Services** key on the phone.
2. Select "**Voicemail**".
3. Use the   keys to scroll through the line items in the Voicemail list.
4. When you have selected a line item, press the  handsfree key,  **Scroll Right** key, or press a line softkey to make an outgoing call using the voicemail access phone number associated with the line for which the voicemail account is registered.

From a selected item in the Voicemail list, you can also lift the handset (go offhook) to make an outgoing call using the voicemail access phone number.

Additional Features

This section describes additional features you can use on the 55i phone.

Star Codes

All of the main call handling and extension management features for your system can be set up as speed dials on softkeys on your phone. Contact your system administrator for more information.

If these have not been set up, you can dial any star code commands on the 55i phone the same way you would on a regular telephone.

Suppressing DTMF Playback

A feature on the IP phones allows you to enable or disable the suppression of DTMF playback when a number is dialed from the softkeys.

When suppression of DTMF playback is disabled, and you press a softkey, the IP phone dials the stored number and displays each digit as dialed in the LCD window.

When the suppression of DTMF playback is enabled, the IP phone dials the stored number and displays the entire number immediately in the LCD window, allowing the call to be dialed faster.

DTMF playback suppression is disabled by default. Suppressing DTMF playback can be configured using the Aastra Web UI.

Configuring Suppression of DTMF Playback



Aastra Web UI

Use the following procedure to configure suppression of DTMF playback.

1. Click on **Basic Settings->Preferences**.

<p>Status</p> <ul style="list-style-type: none"> System Information <p>Operation</p> <ul style="list-style-type: none"> User Password Phone Lock Softkeys and XML Programmable Keys Directory Reset <p>Basic Settings</p> <ul style="list-style-type: none"> Preferences Call Forward 	<p>Preferences</p> <p>General</p> <p>Park Call: <input type="text"/></p> <p>Pick Up Parked Call: <input type="text"/></p> <p>Suppress DTMF Playback <input type="checkbox"/> Enabled</p> <p>Display DTMF Digits <input type="checkbox"/> Enabled</p> <p>Play Call Waiting Tone <input checked="" type="checkbox"/> Enabled</p> <p>Stuttered Dial Tone <input checked="" type="checkbox"/> Enabled</p>
---	---

2. Go to the "**General**" section.
3. Enable the "**Suppress DTMF Playback**" field by checking the check box. (Disable this field by unchecking the box). Default is disabled.
4. Click to save your settings. These changes are not dynamic. You must restart your IP phone for the changes to take affect.
5. Click on **Operation->Reset**.
6. In the "**Restart Phone**" field click to restart the IP phone and apply the changes.

Display DTMF Digits

A feature on the 55i phone allows users to enable or disable DTMF (dual-tone multi-frequency) digits to display to the IP phone when using the keypad to dial, or when dialing from a softkey or programmable key.

DTMF is the signal sent from the phone to the network that you generate when you press the phone's touch keys. This is also known as "touchtone" dialing. Each key you press on your phone generates two tones of specific frequencies. One tone is generated from a high-frequency group of tones and the other from a low frequency group.

If you enable the Display DTMF Digits parameter, the digits you are dialing from the keypad or from a programmable key display to the IP phone's LCD display. This parameter is disabled by default (no digits display when dialing).

You can enable the "Display DTMF Digits" parameter using the Aastra Web UI.

Configuring Display of DTMF Digits



Aastra Web UI

Use the following procedure to configure the display of DTMF digits on the IP phone.

1. Click on **Basic Settings->Preferences->General**.

Status System Information	Preferences
Operation User Password Phone Lock Softkeys and XML Programmable Keys Directory Reset	General
Basic Settings Preferences Call Forward	Park Call: <input type="text"/>
	Pick Up Parked Call: <input type="text"/>
	Suppress DTMF Playback <input type="checkbox"/> Enabled
	Display DTMF Digits <input type="checkbox"/> Enabled
	Play Call Waiting Tone <input checked="" type="checkbox"/> Enabled
	Stuttered Dial Tone <input checked="" type="checkbox"/> Enabled

2. Enable the "**Display DTMF Digits**" field by checking the check box. Disable this field by unchecking the box). Default is disabled.
3. Click to save your settings. These changes are not dynamic. You must restart your IP phone for the changes to take affect.
4. Click on **Operation->Reset**.
5. In the "**Restart Phone**" field click to restart the IP phone and apply the changes.

Stuttered Dial Tone

You can enable or disable the playing of a stuttered dial tone when there is a message waiting on the IP phone.

You can configure this feature using the Aastra Web UI.

Configuring Stuttered Dial Tone



Aastra Web UI

Use the following procedures to configure stuttered dial tone on the IP phone.

1. Click on **Basic Settings->Preferences->General**.

Status	
System Information	
Operation	
User Password	
Phone Lock	
Softkeys and XML	
Programmable Keys	
Directory	
Reset	
Basic Settings	
Preferences	
Call Forward	

Preferences	
General	
Park Call:	<input type="text"/>
Pick Up Parked Call:	<input type="text"/>
Suppress DTMF Playback	<input type="checkbox"/> Enabled
Display DTMF Digits	<input type="checkbox"/> Enabled
Play Call Waiting Tone	<input checked="" type="checkbox"/> Enabled
Stuttered Dial Tone	<input checked="" type="checkbox"/> Enabled

2. Stuttered dial tone is enabled by default. If required, disable the "**Stuttered Dial Tone**" field by unchecking the check box.
3. Click to save your settings.
4. Click on **Operation->Reset**.
5. In the "**Restart Phone**" field click to restart the IP phone.

Play Call Waiting Tone

You can enable or disable the playing of a call waiting tone when a caller is on an active call and a new call comes into the phone.

You can configure this feature using the Aastra Web UI.

Configuring Call Waiting Tone



Aastra Web UI

Use the following procedures to configure a call waiting tone on the IP phone.

1. Click on **Basic Settings->Preferences->General**.

Status System Information	Preferences
Operation User Password Phone Lock Softkeys and XML Programmable Keys Directory Reset	General
Basic Settings Preferences Call Forward	Park Call: <input type="text"/>
	Pick Up Parked Call: <input type="text"/>
	Suppress DTMF Playback <input type="checkbox"/> Enabled
	Display DTMF Digits <input type="checkbox"/> Enabled
	Play Call Waiting Tone <input checked="" type="checkbox"/> Enabled
	Stuttered Dial Tone <input checked="" type="checkbox"/> Enabled

2. A call waiting tone is enabled by default. If required, disable the "Play Call Waiting Tone" field by unchecking the check box.
3. Click to save your settings.
4. Click on **Operation->Reset**.
5. In the "Restart Phone" field click to restart the IP phone.

Incoming Intercom Calls and Auto-Answer

A feature on the 55i IP phone allows you to set intercom settings and automatic answering for incoming intercom calls.

On incoming intercom calls, you can enable (turn ON) or disable (turn OFF) the microphone on the IP phone. You can also enable or disable "Auto-Answer" and "Play Warning Tone" for incoming intercom calls.

If "Auto-Answer" is enabled, the phone automatically answers an incoming intercom call. If "Play Warning Tone" is also enabled, the phone plays a tone to alert the user before answering the intercom call. If "Auto-Answer" is disabled, the phone rejects the incoming intercom call and sends a busy signal to the caller. By default, auto-answer, the microphone, and playing a warning tone are all enabled for incoming intercom calls.

You can set incoming intercom settings and auto-answer using the Aastra Web UI only.

Configuring Incoming Intercom and Auto-Answer



Aastra Web UI

Use the following procedures to configure incoming intercom calls and auto-answer on the IP phone.

1. Click on **Basic Settings->Preferences->Incoming Intercom Settings**.

Status System Information Operation User Password Phone Lock Softkeys and XML Programmable Keys Directory Reset Basic Settings Preferences Call Forward	Preferences General Park Call: <input type="text"/> Pick Up Parked Call: <input type="text"/> Suppress DTMF Playback <input type="checkbox"/> Enabled Display DTMF Digits <input type="checkbox"/> Enabled Play Call Waiting Tone <input checked="" type="checkbox"/> Enabled Stuttered Dial Tone <input checked="" type="checkbox"/> Enabled Incoming Intercom Settings Auto-Answer <input checked="" type="checkbox"/> Enabled Microphone Mute <input checked="" type="checkbox"/> Enabled Play Warning Tone <input checked="" type="checkbox"/> Enabled
---	--

2. The "**Auto-Answer**" field is enabled by default. The automatic answering feature is turned on for the IP phone for answering Intercom calls. To disable this field, uncheck the box.

Note: If the Auto-Answer field is not checked (disabled), the phone rejects the incoming intercom call and sends a busy signal to the caller.

3. The "**Microphone Mute**" field is enabled by default. The microphone is muted on the IP phone for Intercom calls made by the originating caller. To disable this field, uncheck the box.
4. The "**Play Warning Tone**" field is enabled by default. If "Auto-Answer" is enabled, the phone plays a warning tone when it receives in incoming intercom call. To disable this field, uncheck the box.

5. Click to save your settings.

6. Click on **Operation->Reset**.

7. In the "Restart Phone" field click  to restart the IP phone.

Using Redial Key for "Last Number Redial"

The IP phone has an enhanced redial user interface that allows a user to quickly redial the last number that was dialed out from the phone. You can:

- Press the REDIAL button twice to redial the last number dialed.
- Press the REDIAL button once, scroll the list of numbers, then press the REDIAL button again to dial the number that displays on the screen.

The "last number redial" feature for the Redial key is static and is not configurable.

Ring Tones and Tone Sets

You can configure ring tones and ring tone sets on the IP phone.

Ring Tones

There are several distinct ring tones a user can select from to set on the IP phones. You can enable/disable these ring tones on a global or per-line basis.

The following table identifies the valid settings and default values for each type of configuration method.

Ring Tone Settings Table

Configuration Method	Valid Values	Default Value
IP Phone UI	<u>Global:</u> Tone 1 Tone 2 Tone 3 Tone 4	<u>Global:</u> Tone 1
Aastra Web UI	<u>Global:</u> Tone 1 Tone 2 Tone 3 Tone 4 Tone 5 Silent <u>Per-Line:</u> Global Tone 1 Tone 2 Tone 3 Tone 4 Tone 5 Silent	<u>Global:</u> Tone 1 <u>Per-Line:</u> Global

Ring Tone Sets

In addition to ring tones, you can configure ring tone sets on a global-basis on the IP phone. Ring tone sets consist of tones customized for a specific country. The ring tone sets you can configure on the IP phones are:

- **US** (Default - also used in Canada)
- **United Kingdom**
- **Italy**
- **Germany**
- **France**
- **Europe** (generic tones)
- **Australia**

When you configure the country's tone set, the country-specific tone is heard on the phone for the following:

- dial tone
- secondary dial tone
- ring tone
- busy tone
- congestion tones
- call waiting tone
- ring cadence pattern

You configure global ring tones and tone sets using the Aastra Web UI and the IP Phone UI.



Configuring Ring Tones and Tone Sets



IP Phone UI

Use the following procedures to configure ring tones and tone sets on the IP phone.

(global configuration only)

1. Press  on the phone to enter the Options List.
2. Select **Tones**.
3. Select **Set Ring Tone**.
4. Select the type of ring tone (**Tone 1** through **Tone 5**, or **Silent**).
5. Select **Set** and then press .
6. Select **Tone Set**.
7. Select the country for which you want to apply the tone set. Valid values are **Australia**, **Europe**, **France**, **Germany**, **Italy**, **UK**, and **US**. Default is **US**.
8. Press  .
The ring tone and tone set you select is immediately applied to the IP phone.



1. Click on **Basic Settings**->**Preferences**->**Ring Tones**.

Status System Information	Preferences	
	General	
	Park Call:	<input type="text"/>
	Pick Up Parked Call:	<input type="text"/>
	Suppress DTMF Playback	<input type="checkbox"/> Enabled
	Display DTMF Digits	<input checked="" type="checkbox"/> Enabled
	Play Call Waiting Tone	<input checked="" type="checkbox"/> Enabled
	Stuttered Dial Tone	<input checked="" type="checkbox"/> Enabled
	Incoming Intercom Settings	
	Auto-Answer	<input checked="" type="checkbox"/> Enabled
Microphone Mute	<input checked="" type="checkbox"/> Enabled	
Play Warning Tone	<input checked="" type="checkbox"/> Enabled	
Ring Tones		
Tone Set	US <input type="button" value="v"/>	
Global Ring Tone	Tone 2 <input type="button" value="v"/>	
Line 1	Global <input type="button" value="v"/>	
Line 2	Global <input type="button" value="v"/>	
Line 3	Global <input type="button" value="v"/>	
Line 4	Global <input type="button" value="v"/>	
Line 5	Global <input type="button" value="v"/>	
Line 6	Global <input type="button" value="v"/>	
Line 7	Global <input type="button" value="v"/>	
Line 8	Global <input type="button" value="v"/>	
Line 9	Global <input type="button" value="v"/>	
Time and Date Setting		
Time Format	12h <input type="button" value="v"/>	
Date Format	YYYY MMM DD <input type="button" value="v"/>	
Language Settings		
Webpage Language	English <input type="button" value="v"/>	
<input type="button" value="Save Settings"/>		

For global configuration:



2. In the **"Ring Tones"** section, select a country from the **"Tone Set"** field.
3. Select a value from the **"Global Ring Tone"** field.

Note: See the [Ring Tone Settings Table](#) on [page 116](#) for valid values.

For per-line configuration:

4. In the **"Ring Tone"** section, select a line for which you want to set ring tone.
5. Select a value from the **"LineN"** field.

Note: See the [Ring Tone Settings Table](#) on [page 116](#) for valid values.

6. Click  to save your settings. These changes are not dynamic. You must restart your IP phone for the changes to take affect.
7. Click on **Operation->Reset**.
8. In the "**Restart Phone**" field click  to restart the IP phone and apply the ring tone.

Time and Date

On the IP phones, you can configure the following:

- Time and date
- Time and date format
- Time zone
- Daylight savings time

Note: You can set all the above features on the IP Phone UI. However, only the Time and Date Formats can be set using the Aastra Web UI.

Configuring Time and Date

Use the following procedures to configure the time and date settings on the IP phone.



IP Phone UI

Set Time and Time Format

1. Press  on the phone to enter the Options List.
2. Select **Time and Date**.
3. Select **Set Time**.
4. Using the keys on the keypad, enter a time to set on the IP phone.
5. Press **Done** to save the time you entered.
6. Select **Time Format**.
7. Valid values are **12hr** and **24hr**.

Note: The default Time Format is **12hr**.

8. Press **Change** to toggle between 24hr and 12hr format.
9. Press **Done** to save the Time Format you selected.

Set Date and Date Format

1. Select **Set Date**.
2. Using the keys on the keypad, enter a date to set on the IP phone.
3. Press **Done** to save the date you entered.
4. Select **Date Format**.
5. Select a date format from the list of options.

Valid values are:

- WWW MMM DD (default)
- DD-MMM-YY
- YYYY-MM-DD
- DD/MM/YYYY
- DD/MM/YY
- DD-MM-YY
- MM/DD/YY
- MMM DD

Note: The default Date Format is **WWW MMM DD** (Day of Week, Month, Day)

6. Press **Done** to save the Date Format.

Set Time Zone

1. Select **Time Zone**.
2. Press * to display a list of Time Zone options.
3. Select a Time Zone from the list of options.
For valid time zone values, see Appendix B.

Note: The default Time Zone is **US-Eastern**.

4. Press Done to save the Time Zone you selected.

Daylight Savings Time

1. Select **Daylight Savings**.
2. Select a Daylight Savings time from the list of options.
Valid values are:
 - OFF
 - 30 min summertime
 - 1 hr summertime
 - automatic

Note: The default for Daylight Savings is **Automatic**.

3. Press Done to save the Daylight Savings value you selected.



1. Click on **Basic Settings->Preferences->Time and Date Setting.**

Status System Information Operation User Password Phone Lock Softkeys and XML Programmable Keys Directory Reset Basic Settings Preferences Call Forward	Preferences	
	General	
	Park Call:	<input type="text"/>
	Pick Up Parked Call:	<input type="text"/>
	Suppress DTMF Playback	<input type="checkbox"/> Enabled
	Display DTMF Digits	<input type="checkbox"/> Enabled
	Play Call Waiting Tone	<input checked="" type="checkbox"/> Enabled
	Stuttered Dial Tone	<input checked="" type="checkbox"/> Enabled
	Incoming Intercom Settings	
	Auto-Answer	<input checked="" type="checkbox"/> Enabled
	Microphone Mute	<input checked="" type="checkbox"/> Enabled
	Play Warning Tone	<input checked="" type="checkbox"/> Enabled
	Ring Tones	
	Tone Set	US <input type="button" value="v"/>
	Global Ring Tone	Tone 2 <input type="button" value="v"/>
Line 1	Global <input type="button" value="v"/>	
Line 2	Global <input type="button" value="v"/>	
Line 3	Global <input type="button" value="v"/>	
Line 4	Global <input type="button" value="v"/>	
Line 5	Global <input type="button" value="v"/>	
Line 6	Global <input type="button" value="v"/>	
Line 7	Global <input type="button" value="v"/>	
Line 8	Global <input type="button" value="v"/>	
Line 9	Global <input type="button" value="v"/>	
Time and Date Setting		
Time Format	12h <input type="button" value="v"/>	
Date Format	WWW MMM DD <input type="button" value="v"/>	
Language Settings		
Webpage Language	English <input type="button" value="v"/>	
<input type="button" value="Save Settings"/>		

2. In the **“Time Format”** field, select the time format you want to use on your phone. Valid values are:

12h (12 hour format) (default)

24h (24 hour format)

Note: The time displays on the phone’s idle screen in the format you select for this field.

3. In the **"Date Format"** field, select the date format you want to use on your phone. Valid values are:

- WWW MMM DD (default)
- DD-MMM-YY
- YYYY-MM-DD
- DD/MM/YYYY
- DD/MM/YY
- DD-MM-YY
- MM/DD/YY
- MMM DD

Note: The date displays on the phone's idle screen in the format you select.

4. Click to save your settings.

5. Click on **Operation->Reset**.

6. In the **"Restart Phone"** field click to restart the IP phone.

Locking and Unlocking the Phone

You can lock your phone to prevent the phone from being used or configured. You can lock the phone using the IP Phone UI or the Aastra Web UI.

In the Aastra Web UI, the **Operation->Phone Lock** path also allows you to perform the following:

- Reset a user password. Clicking on the “**Reset**” button in the “**Reset User Password**” field displays a screen that allows you to enter and save a new user password.
- Set an emergency dial plan. An emergency dial plan can be 911, 999, 112, 110 or all of the above. The default emergency dial plan is 911|999|112|110.

The following procedures describe locking the phone, setting an emergency dial plan, and resetting the user password.





Locking/Unlocking a Phone

Use the following procedures to lock an IP phone and prevent it from being used or configured.





IP Phone UI

Lock the Phone

1. Press  on the phone to enter the Options List.
2. Select **Phone Lock** and press .
3. Press  to set the phone to lock.
4. Press  on the phone.
The following message displays:
"Phone is locked".

Unlock the Phone

1. Press  on the phone to enter the Options List.
 2. Enter your user password and press .
- The phone unlocks.



1. Click on **Operation->Phone Lock**.

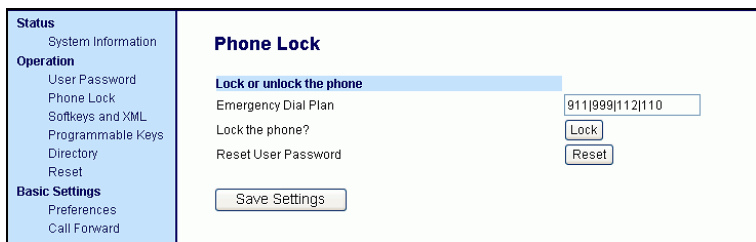

Lock the Phone

2. In the "**Lock the Phone?**" field, click .

The phone locks dynamically and displays the following message:
"Phone is locked".

Unlock the Phone

3. Click on **Operation->Phone Lock**.

4. In the "**Unlock the Phone?**" field, click .

The phone unlocks dynamically and displays the following message:
"Phone is unlocked".

Resetting a User Password

If you forget your password, you can reset it and enter a new password. The reset user password feature resets the password to the factory default which is blank (no password).

You can reset a user password using the Aastra Web UI only.

Note: Valid values when creating or changing a password are 0 to 4294967295 (integers only; symbols and alpha characters are not allowed). Default password is an empty string "" (field is blank).

Use the following procedure to reset a user password.



Aastra Web UI

1. Click on **Operation->Phone Lock**.

Status System Information Operation User Password Phone Lock Softkeys and XML Programmable Keys Directory Reset Basic Settings Preferences Call Forward	<h3>Phone Lock</h3> <p>Lock or unlock the phone</p> <p>Emergency Dial Plan <input type="text" value="911 999 112 110"/></p> <p>Lock the phone? <input type="button" value="Lock"/></p> <p>Reset User Password <input type="button" value="Reset"/></p> <p><input type="button" value="Save Settings"/></p>
---	---

2. In the "Reset User Password" field, click . The following screen displays.

Status System Information Operation User Password Phone Lock Softkeys and XML Programmable Keys Directory Reset Basic Settings Preferences Call Forward	<h3>Reset User Password</h3> <p>Please enter the current and new passwords</p> <p>Current Password <input type="text"/></p> <p>New Password <input type="text"/></p> <p>Password Confirm <input type="text"/></p> <p><input type="button" value="Save Settings"/></p>
---	--

- In the "Current Password" field, leave this blank.
- In the "New Password" field, enter a new password.
- In the "Password Confirm" field, re-enter your new user password.
- Click to save your settings.

Defining an Emergency Dial Plan

Public telephone networks in countries around the world have a single emergency telephone number (emergency services number), that allows a caller to contact local emergency services for assistance when required. The emergency telephone number may differ from country to country. It is typically a three-digit number so that it can be easily remembered and dialed quickly. Some countries have a different emergency number for each of the different emergency services.

You can specify the digits to dial on the IP phone for contacting emergency services. Once you specify the emergency number(s) on the phone, you can dial those numbers directly on the dial pad when required and the phone automatically dials to those emergency services.

Note: Contact your local phone service provider for available emergency numbers in your area.

The following table describes the default emergency numbers on the IP phones.

Emergency Number	Description
911	A United States emergency number
999	A United Kingdom emergency number
112	An international emergency telephone number for GSM mobile phone networks. In all European Union countries it is also the emergency telephone number for both mobile and fixed-line telephones.
110	A police and/or fire emergency number in Asia, Europe, Middle East, and South America.

You can set the emergency dial plan using the Aastra Web UI.

Use the following procedure to specify the numbers to use on your phone for dialing emergency services in your area.



Aastra Web UI

1. Click on **Operation->Phone Lock**.

Status System Information	Phone Lock
Operation User Password Phone Lock Softkeys and XML Programmable Keys Directory Reset	Lock or unlock the phone Emergency Dial Plan <input type="text" value="911 999 112 110"/> Lock the phone? <input type="button" value="Lock"/> Reset User Password <input type="button" value="Reset"/> <input type="button" value="Save Settings"/>
Basic Settings Preferences Call Forward	

2. In the "Emergency Dial Plan" field, enter the 3-digit number used in your local area to contact emergency services. For multiple numbers, enter a "|" between each emergency number. For example:

911|110

Default for this field is **911|999|112|110**.

3. Click to save the emergency dial plan to your phone.

Language

The IP phones support several different languages. You can have the IP Phone UI and the Aastra Web UI display in a specific language as required. When you set the language to use, all of the display screens (menus, services, options, configuration parameters, etc.) display in that language. The IP phones support the following languages:

- English (default)
- French
- Spanish
- German
- Italian

Specifying the Language to Use



Once the language pack(s) are available on your phone from your System Administrator, you can specify which language to use on the phone and/or the Aastra Web UI.

Note: All languages may not be available for selection. The available languages are dependant on the language packs currently loaded to the IP phone.



IP Phone UI

Use the following procedure to specify which language to use for the IP Phone UI.

1. Press  on the phone to enter the Options List.
2. Select **Language** and press .
3. Select **English** (English), **Francais** (French), **Espanol** (Spanish), **Deutsch** (German), or **Italiano** (Italian). Default is English.

Note: All languages may not be available for selection. The available languages are dependant on the language packs currently loaded to the IP phone. English is the default language and cannot be changed or removed. For more information about loading language packs, see your System Administrator.

4. Press  to set the language on the phone.
The language you select displays a check mark indicating this is the current language for the IP Phone UI. The change is dynamic. When you exit the Options Menu, the phone displays all menu items in the language you selected.



Note: You must have the language pack(s) already loaded to your phone in order to use them. For more information about loading language packs, see your System Administrator.

1. Click on **Basic Settings->Preferences->Language Settings**.

The screenshot shows the 'Preferences' page in the Aastra Web UI. The left sidebar contains a navigation menu with categories: Status, Operation, and Basic Settings. Under 'Basic Settings', 'Preferences' is selected. The main content area is titled 'Preferences' and is divided into several sections:

- General:** Includes fields for 'Park Call' and 'Pick Up Parked Call'. It also has checkboxes for 'Suppress DTMF Playback' (disabled), 'Display DTMF Digits' (disabled), 'Play Call Waiting Tone' (checked), and 'Stuttered Dial Tone' (checked).
- Incoming Intercom Settings:** Includes checkboxes for 'Auto-Answer' (checked), 'Microphone Mute' (checked), and 'Play Warning Tone' (checked).
- Ring Tones:** Includes a 'Tone Set' dropdown menu (set to 'US') and 'Global Ring Tone' dropdown (set to 'Tone 2'). Below these are nine 'Line' dropdown menus (Line 1 through Line 9), all set to 'Global'.
- Time and Date Setting:** Includes 'Time Format' (set to '12h') and 'Date Format' (set to 'WWW MMM DD').
- Language Settings:** Includes 'Webpage Language' dropdown menu (set to 'English').

A 'Save Settings' button is located at the bottom of the main content area.

2. In the “**Webpage Language**” field, select a language to apply to the Aastra Web UI. The IP phone supports the following languages:

English (default)

French

Spanish

German

Italian

Note: All languages may not be available for selection. The available languages are dependant on the language packs currently loaded to the IP phone by your System Administrator. English is the default language and cannot be changed or removed.

3. Click  to save your settings. The change is dynamic. The Aastra Web UI displays all screens in the language you selected.

Model 536 Expansion Modules (536EM)

The 55i IP Phone offers optional Expansion Modules that attach to the right side of the phone to provide additional softkeys.

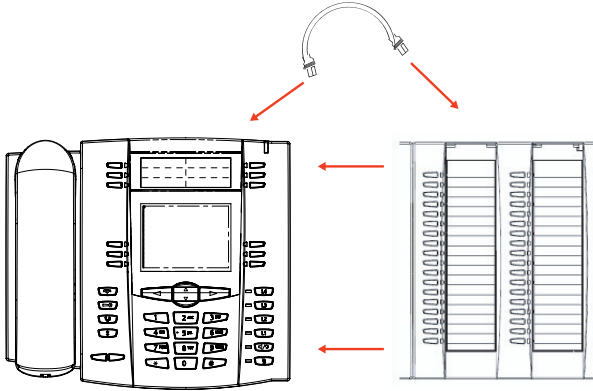

The 536EM provides 36 additional softkeys on a 55i IP Phone. The softkeys support the following features:

- BLF
- Speedial
- Shared Call Appearance

Each key provides an LED for indicating call status. The 536EM provides a paper label for convenient key labeling.

Additional 536EM modules (up to 3 total modules) can be piggy-backed to an existing module providing an additional 108 softkeys to the phone. You connect the additional modules to the right side of an existing module. The following figure illustrates the addition of multiple 536EM modules on the 55i IP Phone.

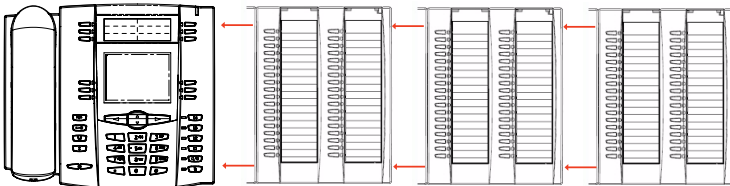

You can configure the softkeys using the Aastra Web UI.

References

For more information about configuring softkeys, see [Softkeys and Programmable Keys](#) on page 24.



For more information about installing 536EM modules on your phone, see the [Aastra 55i IP Phone Installation Guide](#).

Troubleshooting Solutions

Why is my display blank?

Ensure that power is being provided to your phone. If your network does not provide inline power over Ethernet, you can obtain an additional accessory, the Aastra PoE (Power over Ethernet) inline power supply, to provide power over Ethernet locally to your phone. See the section **“Connecting to the Network and to Power”** in the *Aastra 55i Installation Guide* for details.

Why is my speakerphone not working?

If you press the  button and the speaker light flashes and you do not hear dial tone through the speaker phone, the Set Audio option in the phone's Options list has been set up for headset use. Press  a second time and if the light goes out, the phone has been set up to be used only with a headset or handset. If the light stays on steady and you hear dial tone, the phone has been set up so that you can alternate between the speakerphone and the headset by pressing . See the section **“Customizing your phone”** in the *55i Installation Guide* for instructions on how to change the Set Audio option.

Why can't I get a dial tone?

Check for any loose connections and that the phone has been installed properly. For installation instructions, please refer to the **“Installation and Setup”** section in the *Aastra 55i Installation Guide* provided with your phone.

Why doesn't my phone ring?

Check the ring volume on your phone. It may be turned down or turned off. To adjust the ringer volume setting, press the volume button when the phone is on-hook and idle. For more information, refer to the **“Adjusting Volume section”** in the *Aastra 55i Installation Guide* provided with your phone.

Why is the light not coming on with a new Voice Mail Message?

Your phone system or service provider must provide “Visual” Message Waiting service for this function to work. Check with your system administrator for more information.

Why is my handset not working?

Check to ensure that the handset cord is fully connected to both the phone and handset. See the section **“Connecting a Handset or Headset”** in the *Aastra 55i Installation Guide* for information.

What are services, and how do I use them?

Services on the IP phone include:

- XML Applications
- Callers List
- Directory List
- Voicemail

See the section, "[Setting Services Softkey](#)" on [page 63](#) more information about the options available under "Services".

How do I find the IP address of my phone?

Instructions on where to find the IP address of your phone can be found in this guide in the section, "[Finding Your Phone's IP Address](#)" on [page 14](#).

Why does my phone display the "No Service" message?

The phone displays the "**No Service**" message if the SIP settings have not been set up correctly.

Contact your system administrator for more information.

How do I change my user password?

You can change the user password from the IP phone UI or the Aastra Web UI.



IP Phone UI

1. Press  on the phone to enter the Options List.
2. Select **User Password** and press ► .
3. Enter the current user password and press ► .
4. Enter the new user password and press ► .
5. Re-enter the new user password and press ► .
A message, "Password Changed" displays on the screen.



Aastra Web UI

1. Click on **Operation->User Password**.
2. In the "**Current Password**" field, enter the current user password.
Note: By default, the user name is "user" (all lowercase) and the password field is left blank. If you have forgotten your password, contact your system administrator for assistance.
3. In the "**New Password**" field, enter the new user password.
4. In the "**Password Confirm**" field, enter the new user password again.
5. Click  to save your changes.

For information on how to access the Aastra Web UI, go to the section "[Using the Aastra Web UI](#)" on [page 15](#).

Why does my phone display "Bad Encrypted Config"?







The IP phone displays "Bad Encrypted Config" because encrypted configuration files are enabled but the decryption process has failed.

Report this error to your system administrator.

How do I restart the IP phone?



IP Phone UI

1. Press the  button on the phone to enter the Option List.
2. Use the  key to scroll down the list of options to **Phone Status** and press the  key to select.
3. Press the  key to scroll to the **Restart Phone** option.
4. Press the  key to confirm and restart the phone. If you do not wish to restart your phone, press the  key to cancel.

Note: Your phone will be out of service temporarily during the restart and downloading process.



Aastra Web UI

1. Click on **Operation->Reset**.

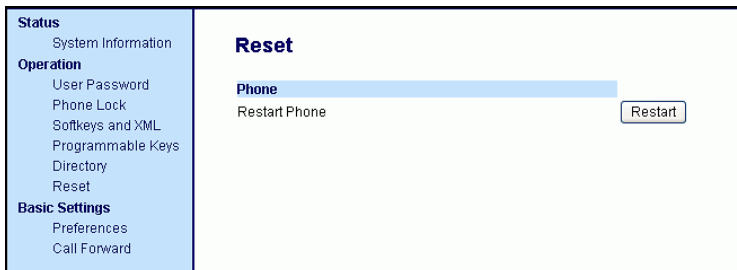

2. Click .
3. Click **OK** at the confirmation prompt.

Limited Warranty

Aastra Telecom warrants this product against defects and malfunctions during a one (1) year period from the date of original purchase. If there is a defect or malfunction, Aastra Telecom shall, at its option, and as the exclusive remedy, either repair or replace the telephone set at no charge, if returned within the warranty period.

If replacement parts are used in making repairs, these parts may be refurbished, or may contain refurbished materials. If it is necessary to replace the telephone set, it may be replaced with a refurbished telephone of the same design and color. If it should become necessary to repair or replace a defective or malfunctioning telephone set under this warranty, the provisions of this warranty shall apply to the repaired or replaced telephone set until the expiration of ninety (90) days from the date of pick up, or the date of shipment to you, of the repaired or replacement set, or until the end of the original warranty period, whichever is later. Proof of the original purchase date is to be provided with all telephone sets returned for warranty repairs.

Exclusions

Aastra Telecom does not warrant its telephone sets to be compatible with the equipment of any particular telephone company. This warranty does not extend to damage to products resulting from improper installation or operation, alteration, accident, neglect, abuse, misuse, fire or natural causes such as storms or floods, after the telephone is in your possession.

Aastra Telecom shall not be liable for any incidental or consequential damages, including, but not limited to, loss, damage or expense directly or indirectly arising from the customer's use of or inability to use this telephone, either separately or in combination with other equipment. This paragraph, however, shall not apply to consequential damages for injury to the person in the case of telephones used or bought for use primarily for personal, family or household purposes.

This warranty sets forth the entire liability and obligations of Aastra Telecom with respect to breach of warranty, and the warranties set forth or limited herein are the sole warranties and are in lieu of all other warranties, expressed or implied, including warranties or fitness for particular purpose and merchantability.

Warranty Repair Services

Should the set fail during the warranty period;

In North America, please call 1-800-574-1611 for further information.

Outside North America, contact your sales representative for return instructions.

You will be responsible for shipping charges, if any. When you return this telephone for warranty service, you must present proof of purchase.

After Warranty Service

Aastra Telecom offers ongoing repair and support for this product. This service provides repair or replacement of your Aastra Telecom product, at Aastra Telecom's option, for a fixed charge. You are responsible for all shipping charges. For further information and shipping instructions;

In North America, contact our service information number: 1-800-574-1611.

Outside North America, contact your sales representative.

Note: Repairs to this product may be made only by the manufacturer and its authorized agents, or by others who are legally authorized. This restriction applies during and after the warranty period. Unauthorized repair will void the warranty.

Appendix A - Time Zone Codes

The following table identifies the time zone name and time zone code to use on the IP phone.

Time Zone Name/Time Zone Code Table

Time Zone Name	Time Zone Code
AD-Andorra	CET
AG-Antigua	AST
AI-Anguilla	AST
AL-Tirane	CET
AN-Curacao	AST
AR-Buenos Aires	ART
AS-Pago Pago	BST
AT-Vienna	CET
AU-Lord Howe	LHS
AU-Tasmania	EST
AU-Melbourne	EST
AU-Sydney	EST
AU-Broken Hill	CST
AU-Brisbane	EST
AU-Lindeman	EST
AU-Adelaide	CST
AU-Darwin	CST
AU-Perth	WST
AW-Aruba	AST
BA-Sarajevo	EET
BB-Barbados	AST
BE-Brussels	CET
BG-Sofia	EET
BM-Bermuda	AST
BO-La Paz	BOT
BR-Noronha	FNT
BR-Belem	BRT
BR-Fortaleza	BRT
BR-Recife	BRT
BR-Araguaina	BRS
BR-Maceio	BRT
BR-Sao Paulo	BRS
BR-Cuiaba	AMS
BR-Porto Velho	AMT
BR-Boa Vista	AMT
BR-Manaus	AMT
BR-Eirunepe	ACT
BR-Rio Branco	ACT
BS-Nassau	EST
BY-Minsk	EET
BZ-Belize	CST

Appendix A - Time Zone Codes

Time Zone Name	Time Zone Code
CA-Newfoundland	NST
CA-Atlantic	AST
CA-Eastern	EST
CA-Saskatchewan	EST
CA-Central	CST
CA-Mountain	MST
CA-Pacific	PST
CA-Yukon	PST
CH-Zurich	CET
CK-Rarotonga	CKS
CL-Santiago	CLS
CL-Easter	EAS
CN-China	CST
CO-Bogota	COS
CR-Costa Rica	CST
CU-Havana	CST
CY-Nicosia	EES
CZ-Prague	CET
DE-Berlin	CET
DK-Copenhagen	CET
DM-Dominica	AST
DO-Santo Domingo	AST
EE-Tallinn	EET
ES-Madrid	CET
ES-Canary	WET
FI-Helsinki	EET
FJ-Fiji	NZT
FK-Stanley	FKS
FO-Faeroe	WET
FR-Paris	CET
GB-London	GMT
GB-Belfast	GMT
GD-Grenada	AST
GF-Cayenne	GFT
GI-Gibraltar	CET
GP-Guadeloupe	AST
GR-Athens	EET
GS-South Georgia	GST
GT-Guatemala	CST
GU-Guam	CST
GY-Guyana	GYT

Time Zone Name	Time Zone Code
HK-Hong Kong	HKS
HN-Tegucigalpa	CST
HR-Zagreb	CET
HT-Port-au-Prince	EST
HU-Budapest	CET
IE-Dublin	GMT
IS-Reykjavik	GMT
IT-Rome	CET
JM-Jamaica	EST
JP-Tokyo	JST
KY-Cayman	EST
LC-St Lucia	AST
LI-Vaduz	CET
LT-Vilnius	EET
LU-Luxembourg	CET
LV-Riga	EET
MC-Monaco	CET
MD-Chisinau	EET
MK-Skopje	CET
MQ-Martinique	AST
MS-Montserrat	AST
MT-Malta	CET
MX-Mexico City	CST
MX-Cancun	CST
MX-Merida	CST
MX-Monterrey	CST
MX-Mazatlan	MST
MX-Chihuahua	MST
MX-Hermosillo	MST
MX-Tijuana	PST
NI-Managua	CST
NL-Amsterdam	CET
NO-Oslo	CET
NR-Nauru	NRT
NU-Niue	NUT
NZ-Auckland	NZS
NZ-Chatham	CHA
PA-Panama	EST
PE-Lima	PES
PL-Warsaw	CET
PR-Puerto Rico	AST
PT-Lisbon	WET
PT-Madeira	WET
PT-Azores	AZO
PY-Asuncion	PYS

Appendix A - Time Zone Codes

Time Zone Name	Time Zone Code
RO-Bucharest	EET
RU-Kaliningrad	EET
RU-Moscow	MSK
RU-Samara	SAM
RU-Yekaterinburg	YEK
RU-Omsk	OMS
RU-Novosibirsk	NOV
RU-Krasnoyarsk	KRA
RU-Irkutsk	IRK
RU-Yakutsk	YAK
RU-Vladivostok	VLA
RU-Sakhalin	SAK
RU-Magadan	MAG
RU-Kamchatka	PET
RU-Anadyr	ANA
SE-Stockholm	CET
SG-Singapore	SGT
SI-Ljubljana	CET
SK-Bratislava	CET
SM-San Marino	CET
SR-Paramaribo	SRT
SV-El Salvador	CST
TR-Istanbul	EET
TT-Port of Spain	AST
TW-Taipei	CST
UA-Kiev	EET
US-Eastern	EST
US-Central	CST
US-Mountain	MST
US-Pacific	PST
US-Alaska	AKS
US-Aleutian	HAS
US-Hawaii	HST
UY-Montevideo	UYS
VA-Vatican	CET
YU-Belgrade	CET

Numerics

55i

- additional features of 110
- features of 2
- making calls 79
- requirements of 2

55i line settings 23

A

Aastra Web UI

- basic settings description 17
- operation description 16
- status description 16

about this guide 1

answering incoming calls 86

auto-answer, enabling/disabling 83

B

bad encrypted config 134

BLF List, setting softkey for 41

BLF, setting softkey for 39

C

call forwarding 105

 configuring 106

call waiting tone 113

callers list 100

 deleting entries in 103

 downloading to PC 104

 downloading to phone 104

 editing 102

 using 101

 using on phone 101

Callers List key 22

callers list, softkey for 69

calls

 receiving 86

calls, transferring 89

conferencing calls 90

D

deleting a softkey 76

dial plan, emergency 127

dial tones, stuttered 112

dialing

 pre-dialling a number 79

dialing a number 79

Directory key 22

directory key, softkey for 66

directory list 93

 adding and editing entries 94

 arranging entries 97

 deleting single and multiple entries
 98

 downloading to PC 99

 downloading to server 99

 limitations for 94

 scrolling multiple screens 96

 sorting 93

 using 99

do not disturb, setting softkey for 37

documentation 1

DTMF digits, displaying 111

DTMF, suppressing playback 110

E

emergency dial plan, defining 127

empty key, softkey for 74

expansion module, 536EM 131

G

getting started 3

H

handling calls 87

headset mic 80

headset, using 80

held calls, retrieving 88

hold, automatic 88

I

idle screen 8

installation and setup, 9122i 2

intercom calls 82

intercom calls, incoming and auto-an-
swer 114

Intercom key 22

Intercom key, softkey for 72

Intercom, using 82

introduction 2

IP address, finding 14, 133

K

key descriptions 20

L

language

- overview 129

- specifying on IP phone 129

last call return, softkeys for 60

line, setting a softkey for 30

locking/unlocking the phone 124

M

making calls 79

managing calls 93

microphone, enabling/disabling 83

missed calls indicator

- accessing and clearing 108

- overview 108

multiple line call appearances 23

mute 85

N

network disconnected 7

no service 133

O

on-hold calls 87

options

- setting via the phone UI 12

- setting via the Web UI 14

P

park and pickup, using on phone 59

park/pickup

- configuring a static configuration

- 55

- configuring softkey configuration

- 57

password, resetting user's 126

picking up calls 92

plugging in the phone 3

R

redial 84

restarting the phone 78

ring tone sets 117

ring tones 116

S

Services key 22

services, softkey for 62

softkeys 24

- as BLF 39

- as BLF List 41

- as Callers List Key 68

- as Directory key 65

- as Do Not Disturb 37

- as empty key 74

- as Intercom Key 71

- as Last Call Return 60

- as line/call appearances 28

- as park and pickup 56

- as services 62

- as speeddials 32

- deleting 76

- functions for 25

- state-based 27

speeddial, setting softkey for 32

star codes 110

starting up the phone 3

T

time and date 120

time and date format 120

transferring calls, blind 89

transferring calls, consultative 89

troubleshooting solutions 132

- How do I change my user password? 133

- How do I find the IP address of my phone? 133

- How do I restart the IP phone? 134

- What are services, and how do I use them? 133

- Why can't I get a dial tone? 132

- Why does my phone display "Bad Encrypted Config"? 134

- Why does my phone display the "No Service" message? 133

- Why doesn't my phone ring? 132

- Why is my display blank? 132

- Why is my handset not working? 132

- Why is my speakerphone not working? 132

- Why is the light not coming on with a new Voice Mail Message? 132

U

user password 18

using your phone 20

Index

V

voicemail 86, 109

W

warranty, limited 135

Web UI, using 15

If you've read this owner's manual and consulted the Troubleshooting section and still have problems, please visit our website at www.aastra.com or call 1-800-574-1611 for technical assistance.

© Aastra Telecom Inc.2007 41-001200-00 Rev 01