

Panasonic

Advanced Hybrid System

Operating Instructions

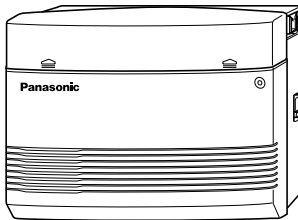

KX-TA308

MODEL **KX-TA616**



This manual was printed
with soy based ink.

**Please read this manual before connecting
the Advanced Hybrid System.**

Thank you for purchasing a Panasonic Telephone System.

System Components

	Model No.	Description
Service Unit	KX-TA308 / KX-TA616	Advanced Hybrid System
Telephone	KX-T7320 KX-T7330 KX-T7350 KX-T7020 KX-T7030 KX-T7033 KX-T7050 KX-T7055 KX-T7130	Proprietary Telephone (12 COs) Proprietary Telephone with LCD (12 COs) Proprietary Telephone (12 COs) Proprietary Telephone (12 COs) Proprietary Telephone with LCD (12 COs) Proprietary Telephone with LCD (12 CO's) and power failure switch Proprietary Telephone (12 COs) Proprietary Telephone (3 COs) Proprietary Telephone with LCD (12 COs)
Optional Equipment	KX-T7340 KX-T7040	DSS Console (32 DSSs, 16 Feature buttons) DSS Console (32 DSSs, 16 Feature buttons)
	KX-TA30860 KX-TA30874 KX-TA30877 KX-TA30891	Doorphone/Door Opener Card Expansion Card (up to 8 extension lines for a single line telephone) Expansion Card (up to 3 outside (CO) lines and 8 extension lines) OGM and FAX Detection Card
	KX-T30865 KX-T7090	Doorphone Headset
	KX-A227	Back-up Battery Cable

NOTICE:

- A Proprietary Telephone is abbreviated as PT.
- A Single Line Telephone is abbreviated as SLT.
- This Operating Instructions does not show complete model number that indicate the country where your models should be used. The model number of your unit is found on the label affixed to the unit.

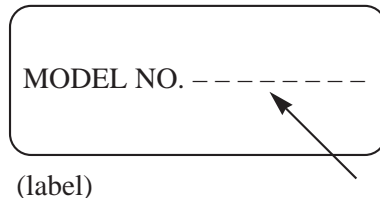

Important Information

Satisfactory performance cannot be guaranteed for each combination of host and subsidiary equipment.

‘Prevention of access by user.’ This equipment is intended to be accessible only by authorized personnel. It must be installed in a locked room or similar environment, so that user access is prevented. Failure to prevent such user access will invalidate any approval given to this equipment.

Precautions

- Keep the unit away from heating and electrical noise generating devices such as fluorescent lamps, motors and televisions.
- This unit should be kept free of dust, moisture, high temperature (more than 40°C / 104°F) and vibration, and should not be exposed to direct sunlight.
- Never attempt to insert wires, pins, etc. into the vents or other holes of this unit.
- Do not use benzine, thinner, or the like, or any abrasive powder to clean the cabinet. Wipe it with a soft cloth.

WARNING

THIS UNIT MAY ONLY BE INSTALLED AND SERVED BY QUALIFIED SERVICE PERSONNEL.

WHEN A FAILURE OCCURS WHICH RESULTS IN THE INTERNAL PARTS BECOMING ACCESSIBLE, DISCONNECT THE POWER SUPPLY CORD IMMEDIATELY AND RETURN THIS UNIT TO YOUR DEALER.

DISCONNECT THE TELECOM CONNECTION BEFORE DISCONNECTING THE POWER CONNECTION PRIOR TO RELOCATING THE EQUIPMENT. THEN RECONNECT THE POWER FIRST.

THIS UNIT IS EQUIPPED WITH AN EARTHING CONTACT PLUG. FOR SAFETY REASONS, THIS PLUG MUST ONLY BE CONNECTED TO AN EARTHING CONTACT SOCKET WHICH HAS BEEN INSTALLED ACCORDING TO REGULATIONS.

THE POWER SUPPLY CORD IS USED AS THE MAIN DISCONNECT DEVICE, ENSURE THAT THE SOCKET-OUTLET IS LOCATED/INSTALLED NEAR THE EQUIPMENT AND IS EASILY ACCESSIBLE.

TO PREVENT FIRE OR SHOCK HAZARD, DO NOT EXPOSE THIS PRODUCT TO RAIN OR MOISTURE.

For your future reference

SERIAL NO. _____ DATE OF PURCHASE _____
(found on the bottom of the unit)

NAME OF DEALER _____

DEALER'S ADDRESS _____

Introduction

Structure of the Manual

This manual consists of the following sections.

Section 1. Operations

Describes the features and their operations. It also provides information about the programming required, conditions and connection references for each feature.

Section 2. Appendix

Provides the Tone/Ring Tone List, LED Indication, Feature Number List and the Telephone Troubleshooting.

Index

Description of the Symbols Mainly Used in this Manual



Additional information and conditions.



The feature or program references.

Contents

Section 1 Operations

Basic Operations

1.1	Before Operating	1-2
1.2	Proprietary Telephone Settings	1-4
	Customizing Your Telephone Functions	1-5
	Customizing the Buttons on Your Telephone	1-8
	Display Contrast Adjustment	1-14
	When Using the Headset	1-14
	Volume Control — Handset Receiver/Headset/Ringer/Speaker	1-15
1.3	Making Calls	1-16
	<Intercom Calling>	
	Intercom Calling	1-16
	Calling an Operator (Operator Call)	1-17
	<Outside Calling>	
	Outside Calling	1-17
	Flash	1-19
	Handsfree Operation	1-20
	Making Emergency Calls (Emergency Call)	1-21
	<Quick Dialing>	
	Dialing by Simply Pressing a Button (One-Touch Dialing)	1-22
	Dialing with System Speed Dialing (System Speed Dialing)	1-23
	Dialing with Personal Speed Dialing (Personal Speed Dialing)	1-24
	Dialing by Simply Going Off-Hook (Pickup Dialing)	1-26
	<Redialing>	
	Redialing Automatically (Automatic Redial)	1-27
	Redialing the Last Number Dialed (Last Number Redial)	1-27
	Redialing the Saved Number (Saved Number Redial)	1-28
	<When the Dialed Line is Busy>	
	Sending a Call Waiting Tone to a Busy Extension (Busy Station Signaling – BSS)	1-29
	Making Your Telephone Ring Back Automatically When a Line Becomes Free (Automatic Callback Busy – Camp-On)	1-30
	Interrupting an Existing Call (Executive Busy Override)	1-31
	Denying “Interrupting an Existing Call” (Executive Busy Override Deny)	1-33
1.4	Receiving Calls	1-34
	Receiving Calls	1-34
	Handsfree Answerback	1-35
	<Pick up a Call>	
	Picking up a Call Ringing at Another Extension (Call Pickup)	1-36

Contents

1.5	During a Conversation	1-38
	<Placing a Call on Hold>	
	Placing a Call on Hold (Call Hold)	1-38
	Placing a Call on Hold Exclusively (Exclusive Hold)	1-39
	Retrieving a Call on Hold (Call Hold Retrieve)	1-40
	Placing a Call in System Parking Area (Call Park)	1-41
	<Transferring Calls>	
	Transferring a Call to an Extension (Call Transfer – to Extension) ...	1-42
	Transferring a Call to an Outside (CO) Line (Call Transfer – to Outside (CO) Line)	1-44
	Call Waiting	1-45
	Call Splitting	1-47
	Paging	1-48
	Turning off the Microphone (Microphone Mute)	1-51
1.6	Before Leaving Your Desk	1-52
	Forwarding a Call (Call Forwarding)	1-52
	Locking Your Telephone (Electronic Station Lockout)	1-57
	Showing Your Message on the Calling Party’s Display (Absent Message Capability)	1-58
<i>Advanced Operations</i>		
1.7	Useful Features	1-59
	Conference (3-party)	1-59
	Conference, Unattended	1-61
	Conference (5-party)	1-62
	Leaving a Message Notification (Message Waiting)	1-65
	Calling with Account Codes (Account Code Entry)	1-67
	Rejecting Incoming Calls (Do Not Disturb — DND)	1-69
	Calling an Extension which Denies Receiving Calls (Do Not Disturb Override)	1-70
	Secret Dialing	1-71
	Alarm Setting (Timed Reminder)	1-72
	Time (Day/Night/Lunch) Service	1-74
	Joining or Leaving a Call Distribution Group (Log-In/Log-Out)	1-75
	Room Monitor	1-76
	Data Line Security	1-77
	Parallel Connection of a Proprietary Telephone and Single Line Telephone (Paralleled Telephone Connection)	1-78
	Mixed Station Dialing	1-78
	External Feature Access	1-79
	Self-Extension Number Confirmation (KX-T7330/KX-T7030/KX-T7130/KX-T7033 only)	1-80
	Turning on the Background Music (BGM)	1-80

Contents

Extension Button Confirmation (KX-T7330/KX-T7030/KX-T7130/KX-T7033 only)	1-81
Pulse to Tone Conversion	1-81
Canceling the Feature Settings (Station Feature Clear)	1-82
Alternate Calling — Ring/Voice (Voice to Ring only)	1-82
Doorphone Call	1-83
Door Opener	1-84
Voice Mail Integration	1-85
Calling Using Your Privileges at Another Extension (Walking COS) ...	1-87
Ringling Pattern Selection	1-88
Distinctive Dial Tone	1-88
Power Failure Transfer	1-89
Lockout	1-89

Operator / Manager Operations

1.8 Operator / Manager Service Features	1-90
Date and Time Setting	1-90
Electronic Station Lockout – CANCEL ALL	1-91
Timed Reminder, Remote (Wake-Up Call)	1-91
Outgoing Message (OGM)	1-93
Remote Station Lock	1-94
Time (Day/Night/Lunch) Service Setting	1-95
Extension Password Set (Manager only)	1-97

DSS Console Operations

1.9 DSS Console Features	1-98
Initial Settings	1-98
Direct Station Dialing	1-101
One-Touch Dialing	1-101
One-Touch Access for System Features	1-102
Call Transfer	1-102

Section 2 Appendix

2.1 Tone / Ring Tone List	2-2
2.2 LED Indication	2-3
2.3 Feature Number List	2-4
2.4 Display Example	2-7
2.5 Troubleshooting	2-11

Index

Section 1

Operations

Basic Operations

Advanced Operations

Operator / Manager
/ DSS Console Operations

1.1 Before Operating

What kind of telephone do you use?

In this manual, you will find how to operate the feature depending on the telephone you use. If you use single line devices such as a single line telephone or data terminal, you will follow the steps which enter a feature number. If you use single line devices which do not have a “*” or “#” key, it is not possible to access features that have “*” or “#” in their feature numbers.

If you use a Panasonic proprietary telephone which has a special function button and/or a display, you will follow the button or display operation for easy access. If you use a Panasonic proprietary telephone which does not have a function button, you may change one of the unused buttons to another button. Refer to Section 1.2, “Proprietary Telephone Settings”.

A Panasonic proprietary telephone has Light Emitting Diode (LED) button indicators, so you can see the line conditions according to the lighting patterns. Refer to Section 2.2, “LED Indication”.

Please use the proper operation for your telephone.

Description of the Symbols Used in this Manual

In this manual, many symbols are used. Some of the symbols need explanation. Those are described below.



Lift the handset, or press the SP-PHONE or MONITOR button (Off-hook).



Flash the hookswitch on a single line telephone.



Replace the handset, or press the SP-PHONE or MONITOR button (On-hook).



Tones which vary depending on the condition.
Refer to “Tone / Ring Tone List” (Section 2.1).



Number keys on the telephone — depends on the condition.



- For proprietary telephone operations, all button illustrations are based on the KX-T7130 model.
- The AUTO ANSWER/MUTE button corresponds to the AUTO ANS/MUTE button on a KX-T7300 series.
- The AUTO DIAL/STORE button corresponds to the AUTO/STORE button on a KX-T7300 series.

1.1 Before Operating

Operating example

Example: “Interrupting an Existing Call (Executive Busy Override)”, Executive Busy Override — Extension

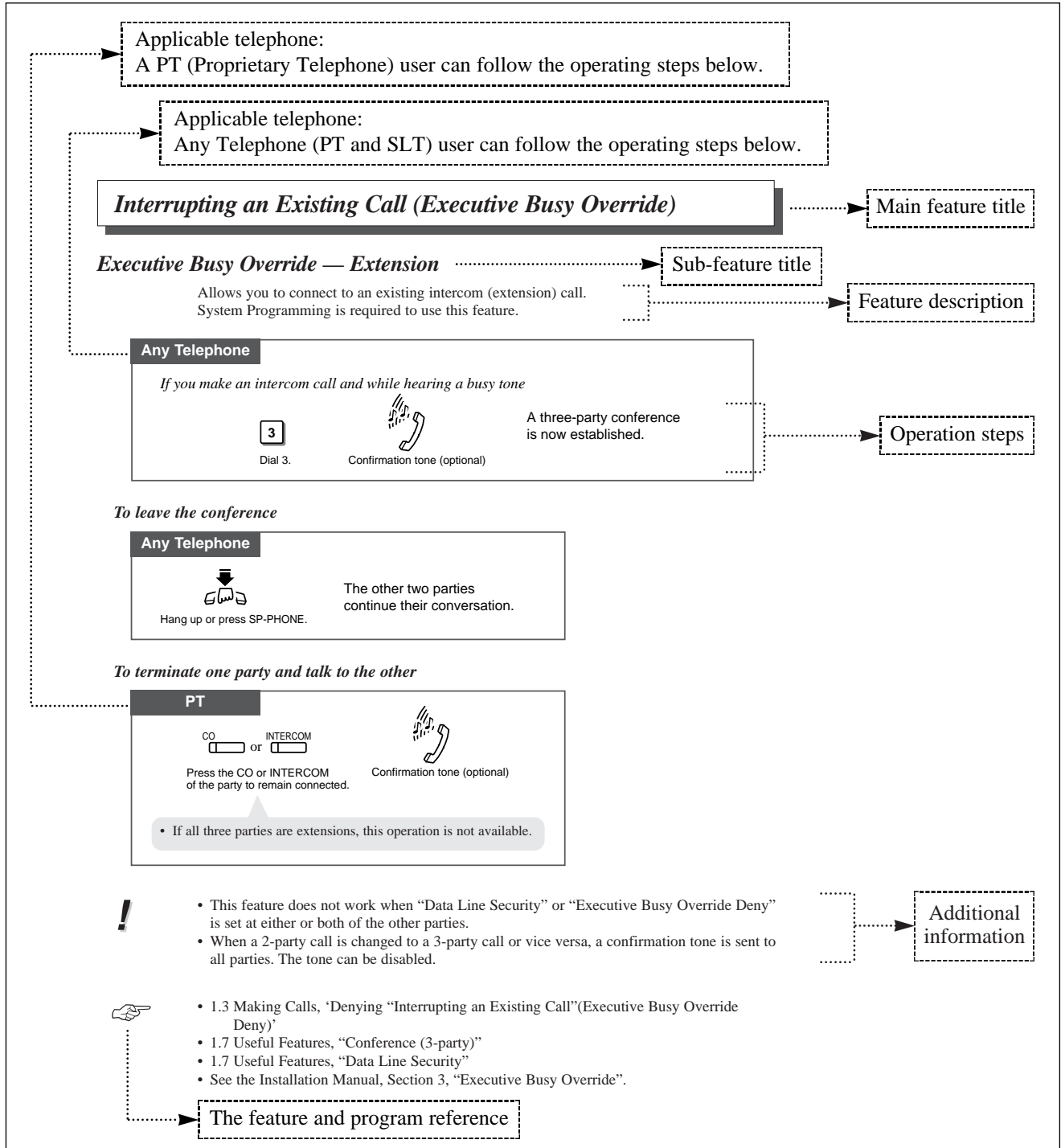

- !** If your telephone is not noted in the operation steps (ex. only “PT” is noted and you are using a single line telephone), this means your telephone cannot execute that feature.
- If your telephone can perform several operations for one feature, you can select the method according to your needs.

1.2 Proprietary Telephone Settings

If you use a Panasonic proprietary telephone, you can customize your telephone functions. For example, you can change the initial settings according to your needs or the button functions on your telephone. To program, you need to switch your telephone to the programming mode. During the programming mode, your telephone is busy to outside callers. If you want to make a normal call operation, you must finish the programming mode.



- This feature cannot be used with a single line telephone.
- Be sure the handset is on the cradle and the SP-PHONE button is off.
- To program, set the MEMORY switch on the proprietary telephone to “PROGRAM” or press the PROGRAM button on the KX-T7300 series.

When you enter the Station Programming mode, the display shows the following message as the initial programming mode.

PITS-PGM NO? →

The display also gives you helpful or stored data information related to the programming steps. You can also refer to the “Display Example” in the Appendix (Section 2.4).

- After programming, return the MEMORY switch to the “SET” position or press the PROGRAM button on the KX-T7300 series.
- If you move your desk and change the extension line, reset as desired. The setting will not remain in your telephone but will remain in the previous extension user’s memory.
- During the programming mode, your extension is treated as a busy extension.

To enter the Programming Mode

PT

Be sure the telephone is idle and on-hook.

MEMORY or PROGRAM

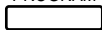
 or 

Set the MEMORY switch to “PROGRAM” on the KX-T7000 series.
OR
Press the PROGRAM button on the KX-T7300 series.

To exit the Programming Mode

PT

When the display shows the initial programming mode;

MEMORY or PROGRAM

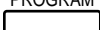
 or 

Set the MEMORY switch to “SET” on the KX-T7000 series.
OR
Press the PROGRAM button on the KX-T7300 series.

Programming is completed and the normal call operation resumes.

When storing data

After pressing the STORE button to store data, you may hear one of the following tones.

- Confirmation tone (1 beep): storage is completed.
- Confirmation tone (2 beeps): the data is the same as the last entry.
- Alarm tone (3 beeps): the entry is not valid.

1.2 Proprietary Telephone Settings

Customizing Your Telephone Functions

You can change the initial settings of your telephone. Check the available items in the list and change the settings, if required.

Preferred Line Assignment — Outgoing

- Idle Line Preference:** You can access any enabled idle outside (CO) line to make a call directly by going off-hook.
- Prime Line Preference:** You can access a programmed outside (CO) line directly by going off-hook.
- No Line Preference: (default)** You cannot access an outside (CO) line by going off-hook. Choose the outside (CO) line.

SELECTION	PROGRAMMING INPUT
<input type="checkbox"/> Idle Line Preference.	<div style="display: flex; align-items: center; gap: 10px;"> <div style="display: flex; gap: 5px;"> <div style="border: 1px solid black; padding: 2px 5px;">1</div> <div style="border: 1px solid black; padding: 2px 5px;">2</div> </div> <div style="text-align: center;"> AUTO DIAL <input style="width: 40px; height: 15px;" type="text"/> STORE </div> </div>
<input type="checkbox"/> Prime Line Preference.	<div style="display: flex; align-items: center; gap: 10px;"> <div style="display: flex; gap: 5px;"> <div style="border: 1px solid black; padding: 2px 5px;">1</div> <div style="border: 1px solid black; padding: 2px 5px;">3</div> </div> <div style="text-align: center;"> <div style="border: 1px solid black; padding: 2px 5px; display: inline-block;">outside (CO) line no.</div> Enter the outside (CO) line number (1 through 6). </div> <div style="text-align: center;"> AUTO DIAL <input style="width: 40px; height: 15px;" type="text"/> STORE </div> </div>
<input type="checkbox"/> No Line Preference.	<div style="display: flex; align-items: center; gap: 10px;"> <div style="display: flex; gap: 5px;"> <div style="border: 1px solid black; padding: 2px 5px;">1</div> <div style="border: 1px solid black; padding: 2px 5px;">1</div> </div> <div style="text-align: center;"> AUTO DIAL <input style="width: 40px; height: 15px;" type="text"/> STORE </div> </div>



- Setting a new line preference feature will cancel the previous setting.
- The user can override the Idle/Prime Line Preference temporarily to select a specific line. To select it, press the desired line access button (INTERCOM or CO button) before going off-hook or pressing the SP-PHONE/MONITOR button.
- If there are only 3 lines in the system, outside (CO) line numbers 4 through 6 cannot be used.

1.2 Proprietary Telephone Settings

Preferred Line Assignment — Incoming

- No Line Preference:** When an incoming outside call is received, the extension user must go off-hook and then press the flashing CO button.
- Prime Line Preference:** When incoming outside calls from the Central Office are received at the same time, you can receive the call on the preferred outside (CO) line first only by going off-hook.
- Ringing Line Preference: (default)** When an incoming outside call is received, you can receive the call ringing at your telephone by going off-hook.

SELECTION	PROGRAMMING INPUT
<input type="checkbox"/> No Line Preference.	<div style="display: flex; align-items: center; gap: 10px;"> <div style="border: 1px solid black; padding: 2px 5px;">2</div> <div style="border: 1px solid black; padding: 2px 5px;">1</div> <div style="border: 1px solid black; padding: 2px;"> AUTO DIAL <input style="width: 40px; height: 15px;" type="text"/> STORE </div> </div>
<input type="checkbox"/> Prime Line Preference.	<div style="display: flex; align-items: center; gap: 10px;"> <div style="border: 1px solid black; padding: 2px 5px;">2</div> <div style="border: 1px solid black; padding: 2px 5px;">3</div> <div style="border: 1px solid black; padding: 2px;"> outside (CO) line no. Enter the outside (CO) line number (1 through 6). </div> <div style="border: 1px solid black; padding: 2px;"> AUTO DIAL <input style="width: 40px; height: 15px;" type="text"/> STORE </div> </div>
<input type="checkbox"/> Ringing Line Preference.	<div style="display: flex; align-items: center; gap: 10px;"> <div style="border: 1px solid black; padding: 2px 5px;">2</div> <div style="border: 1px solid black; padding: 2px 5px;">2</div> <div style="border: 1px solid black; padding: 2px;"> AUTO DIAL <input style="width: 40px; height: 15px;" type="text"/> STORE </div> </div>



- Setting a new line preference feature will cancel the previous setting.
- In “Prime Line Preference” mode, if incoming calls from the Central Office are received at the same time except for the preferred outside (CO) line, you must go off-hook and then press the CO button whose indicator is flashing red quickly.

Outside (CO) Line Ringing Selection

You can select whether the extension will ring or not when an outside call is received at your extension.

PROGRAMMING INPUT		
<div style="border: 1px solid black; padding: 2px 5px; width: 20px; margin: 0 auto;">3</div>	<div style="border: 1px solid black; padding: 2px; margin-bottom: 5px;"> outside (CO) line no. </div> Enter the outside (CO) line numbers you want to ring (1 through 6).	<div style="border: 1px solid black; padding: 2px;"> AUTO DIAL <input style="width: 40px; height: 15px;" type="text"/> STORE </div>



- The “Flexible Ringing Assignment” should be set to “Enable”. (See the Installation Manual.)
- When an outside call is received at your extension but does not ring, the CO indicator will flash. If you want to answer the outside call, press the flashing CO button.

1.2 Proprietary Telephone Settings

Intercom Alert Assignment

The intercom alert (tone/voice) at a receiving extension can be selected by programming.

Voice Call: A Voice alert instead of Tone alert is heard through the speaker on the receiving extension.

Tone Call (default): A tone alert (ringing) sounds at the receiving extension.

SELECTION	PROGRAMMING INPUT
<input type="checkbox"/> Voice Call	4 2 <input type="checkbox"/> AUTO DIAL STORE
<input type="checkbox"/> Tone Call (Cancels the Voice Call.)	4 1 <input type="checkbox"/> AUTO DIAL STORE

Call Waiting Tone Selection

You can select the call waiting tone, either Tone 1 (default) or Tone 2.

SELECTION	PROGRAMMING INPUT
<input type="checkbox"/> Tone 1	5 1 <input type="checkbox"/> AUTO DIAL STORE
<input type="checkbox"/> Tone 2	5 2 <input type="checkbox"/> AUTO DIAL STORE



- 1.5 During a Conversation, “Call Waiting”
- 2.1 Tone / Ring Tone List

Proprietary Telephone Setting Data Default Set

Allows you to reset the proprietary telephone settings at an extension to the default settings.

- Preferred Line Assignment — Outgoing (default: No Line Preference)
- Preferred Line Assignment — Incoming (default: Ringing Line)
- Outside (CO) Line Ringing Selection (default: Ring – all outside (CO) lines)
- Intercom Alert Assignment (default: Tone Call)
- Call Waiting Tone Selection (default: Tone 1)

OPERATION
* <input type="checkbox"/> AUTO DIAL STORE



- This feature also cancels the Handsfree Answerback feature and pressing the AUTO ANSWER/MUTE button in the Room Monitor feature.

1.2 Proprietary Telephone Settings

Customizing the Buttons on Your Telephone

Changing the Flexible Buttons

You can change the flexible buttons on your telephone to certain function buttons. For example, if your telephone has more CO buttons than available outside (CO) lines, you may change the unused CO buttons to One-Touch Dialing buttons, etc.

The 4 types of flexible buttons are as follows:

- **Flexible CO Buttons** (located on a PT only)
- **Flexible DSS Buttons** (located on a DSS Console only)
- **Programmable Feature (PF) Buttons** (located on a PT and DSS Console)
- **Flexible MESSAGE Buttons** (located on a PT except for the KX-T7055)

Check the required operation first. If your telephone is not provided with the button, you can assign the button using this program.

FUNCTION	PROGRAMMABLE BUTTON			
	CO	DSS	PF	MESSAGE
DSS (Direct Station Selection)	✓	✓		✓
One-Touch Dialing	✓	✓	✓	✓
CONF (Conference)	✓			
FWD/DND (Forward/Do Not Disturb)	✓			
SAVE	✓			
Log-In/Log-Out	✓			
Single-CO (S-CO)	✓			
Other CO (O-CO)	✓			
Group-CO (G-CO)	✓			
MESSAGE (Message Waiting)				✓
Day		✓		
Night		✓		
Lunch		✓		
Station Lock		✓		

“✓” indicates that the feature is available.



- **To confirm the stored function data**

Press the button you want to confirm.

- As to the buttons on your proprietary telephone, please refer to your proprietary telephone manual.

1.2 Proprietary Telephone Settings

Line Access Buttons

One of the following 3 types of CO buttons must be used to seize an outside (CO) line when making a call.

- **Group-CO (G-CO) button**
- **Other-CO (O-CO) button**
- **Single-CO (S-CO) button**



- A flexible CO button can be assigned as a Line Access Button (G-CO, O-CO or S-CO) in Proprietary Telephone Settings. Once a flexible CO button is assigned as a Line Access Button, it provides the line status using lighting patterns and color indication. Please refer to “2.2 LED Indication”.
- You can set the G-CO and S-CO buttons on one telephone. Incoming and outgoing calls on the line are shown on the button in the following priority. S-CO > G-CO

Single-CO (S-CO) Button

A S-CO button is an outside (CO) line access button. This allows you to access a specific line by pressing a S-CO button. An incoming call can be directed to a S-CO button.

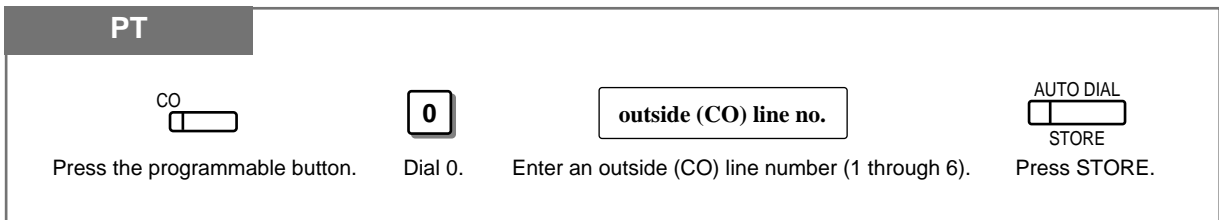

- Only one S-CO button can be assigned to an outside (CO) line.
- The same outside (CO) line can be assigned as a S-CO button and G-CO button.

Other CO (O-CO) Button

Outside (CO) lines which are not assigned to S-CO or G-CO buttons can be assigned to a flexible CO button on a proprietary telephone. The assigned button serves as the O-CO button. An incoming call, on assigned outside (CO) lines, arrives at the O-CO button. To make an outside call, you simply press the designated O-CO button.



1.2 Proprietary Telephone Settings

Group-CO (G-CO) Button

To use outside (CO) lines and a group of outside (CO) lines (outside (CO) line group) efficiently can be assigned to a CO button. This button is referred to as Group-CO (G-CO) button. Any incoming calls from any outside (CO) line in the outside (CO) line group arrive at the G-CO button. To make an outside call, you can access an idle outside (CO) line in the group by simply pressing the assigned G-CO button.

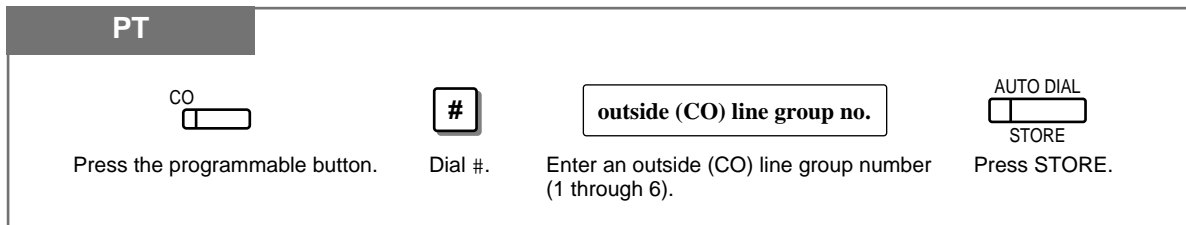

- The same line can be assigned as a S-CO button and G-CO button.
- The extension for making and/or receiving calls in outside (CO) line groups must be programmed.
- When your extension is assigned as the incoming call destination for an outside (CO) line, you cannot receive any incoming outside calls unless a G-CO, O-CO or S-CO button associated with the line is assigned.

DSS (Direct Station Selection) Button

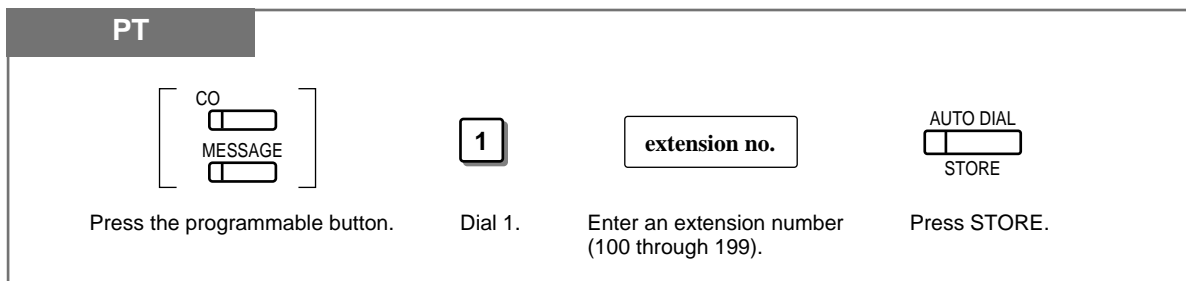

1.2 Proprietary Telephone Settings

One-Touch Dialing Button

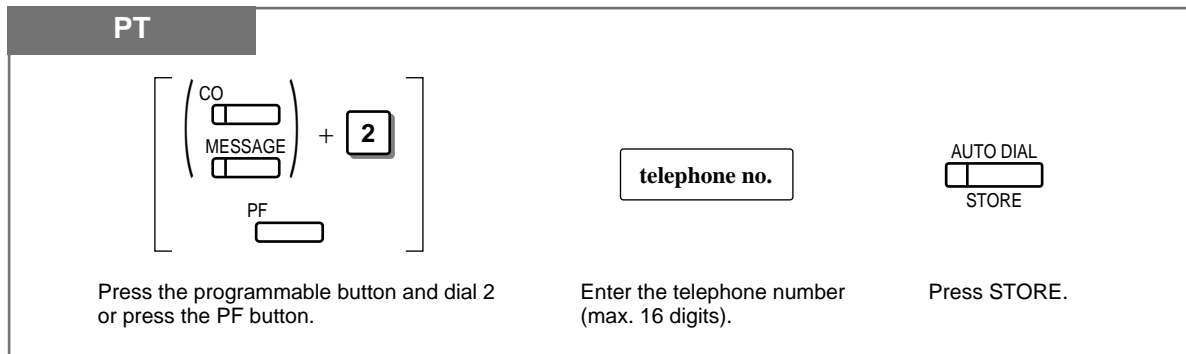

- To store the telephone number of an external party, a line access code (9, 0 or 81 through 86) must be stored as the first digit.
- You can use 0 through 9, *, #, PAUSE and INTERCOM (Secret) as follows.
PAUSE: inserts a pause.
INTERCOM: conceals all or part of a stored number.
- The number of Personal Speed Dialing numbers corresponds to the number of PF buttons assigned as One-Touch Dialing. (PF buttons are on a proprietary telephone.) You cannot assign both the One-Touch Dialing and Personal Speed Dialing features to the same number. For example, if you assign One-Touch Dialing to the PF 1 button and then Personal Speed Dialing 0, only the Personal Speed Dialing 0 feature will be assigned.



- 1.7 Useful Features, “Secret Dialing”

CONF (Conference) Button

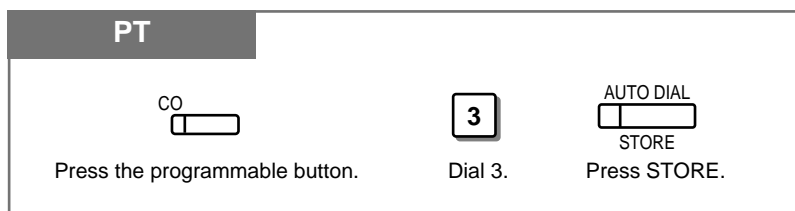

- 1.7 Useful Features, “Conference (3-party)”
- 1.7 Useful Features, “Conference, Unattended”
- 1.7 Useful Features, “Conference (5-party)”

1.2 *Proprietary Telephone Settings*

FWD/DND (Forward/Do Not Disturb) Button

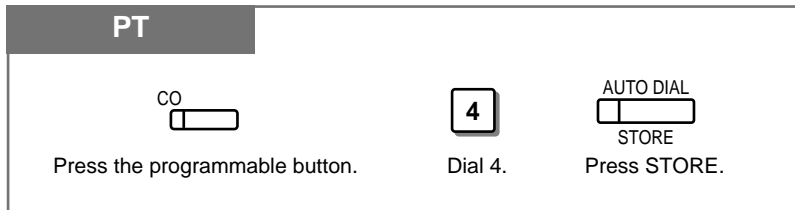

- 1.6 Before Leaving Your Desk, “Forwarding a Call (Call Forwarding)”
- 1.7 Useful Features, “Rejecting Incoming Calls (Do Not Disturb – DND)”

SAVE Button

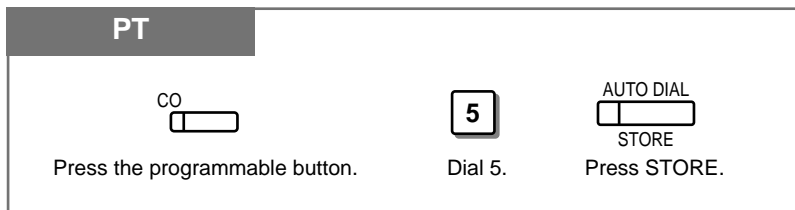

- 1.3 Making Calls, “Redialing the Saved Number (Saved Number Redial)”

Log-In/Log-Out Button

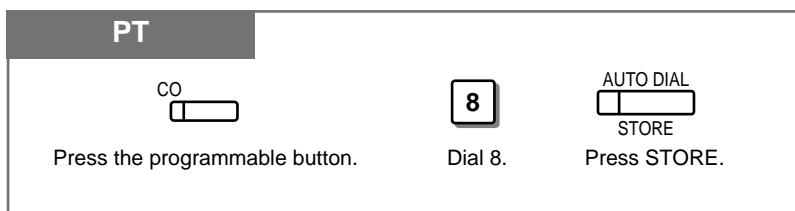

- 1.7 Useful Features, “Joining or Leaving a Call Distribution Group (Log-In/Log-out)”
- See the Installation Manual, Section 3, “Log-In/Log-Out”.

1.2 Proprietary Telephone Settings

Restoring the MESSAGE Button

Allows you to restore the message waiting feature to the MESSAGE button.

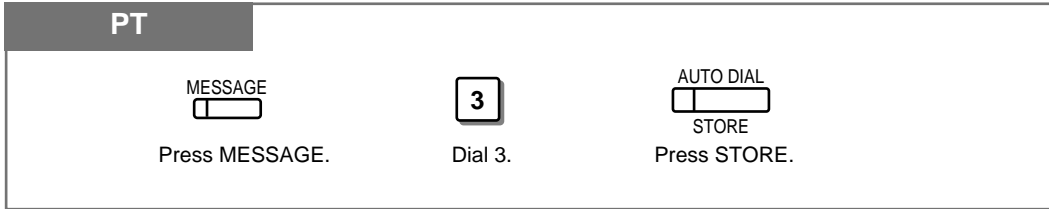

One-Touch Access for System Features

Features that can be accessed using the dialing buttons can also be programmed into memory.

Programming

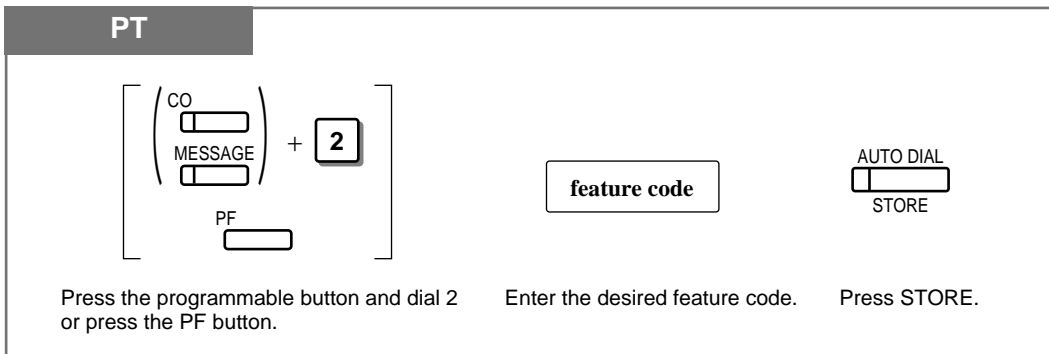

- If you want to use a programmable feature button as a button for External Feature Access, you can press the FLASH button instead of the feature code. When you press the assigned button, you can access special features (e.g. Call Waiting) offered by a host PBX or Central Office.

To Access

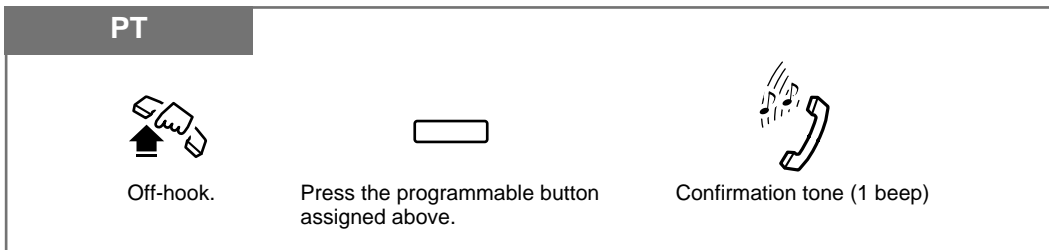

- Whether the confirmation tone is heard or not depends upon the programmable feature.

1.2 *Proprietary Telephone Settings*

Display Contrast Adjustment

The CONTRAST selector is used to adjust the display contrast.

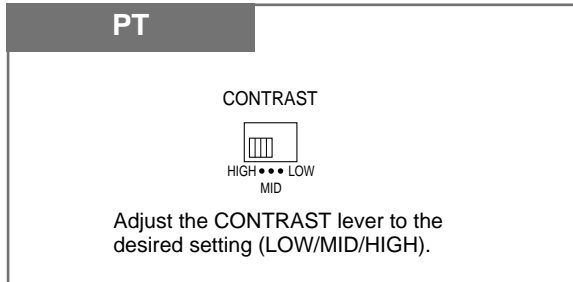

- This feature is available for a KX-T7330/KX-T7033/KX-T7030/KX-T7130 only.

When Using the Headset

The Panasonic Advanced Hybrid System supports the use of a headset on a proprietary telephone (PT). When you use the headset (optional), you should switch the selection mode first.

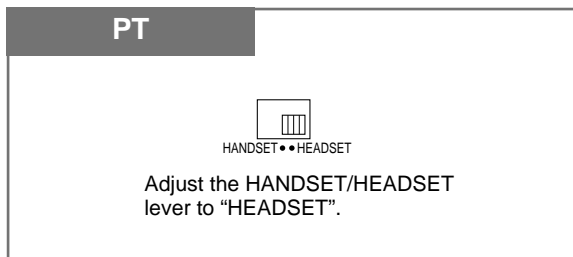

- This feature is available for a KX-T7330/KX-T7033/KX-T7030/KX-T7130 only.

1.2 Proprietary Telephone Settings

Volume Control — Handset Receiver/Headset/Ringer/Speaker

Allows you to adjust the following volumes as necessary.

To adjust the handset receiver volume

PT

HANDSET VOLUME



NORMAL ••• HIGH

or

VOLUME 

Adjust the HANDSET VOLUME lever to the desired setting (three levels from NORMAL to HIGH) on the KX-T7000 series.
OR
Press the VOLUME Control buttons on the KX-T7300 series.

To adjust the headset volume

PT

Be sure the headset is connected.

HANDSET VOLUME



NORMAL ••• HIGH

or

VOLUME 

Adjust the HANDSET VOLUME lever to the desired setting (three levels from NORMAL to HIGH) on the KX-T7000 series.
OR
Press the VOLUME Control buttons on the KX-T7300 series.

To adjust the ringer volume

PT

RINGER



HIGH ••• OFF
LOW

Adjust the RINGER Volume lever to the desired setting (OFF/LOW/HIGH).

To adjust the speaker volume

PT

VOLUME



MAX MIN

or

VOLUME 

Adjust the VOLUME Control lever to the desired setting (MAX to MIN) on the KX-T7000 series.
OR
Press the VOLUME Control buttons on the KX-T7300 series.

1.3 Making Calls

Intercom Calling

Allows you to make a call to another extension.

Using the handset

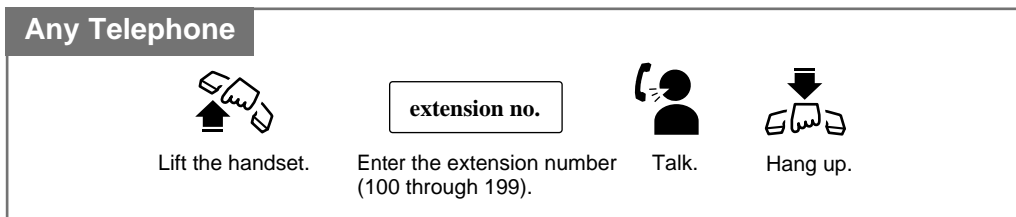

Using the Speakerphone

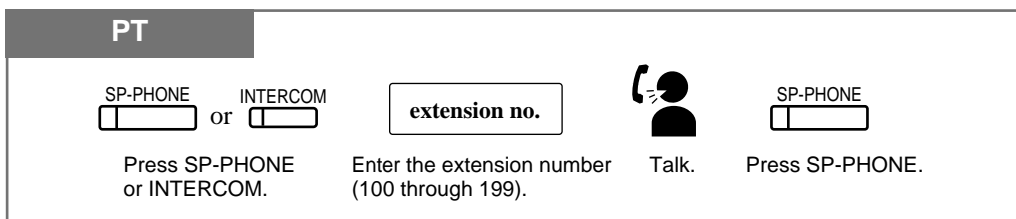

Using a DSS (Direct Station Selection) button

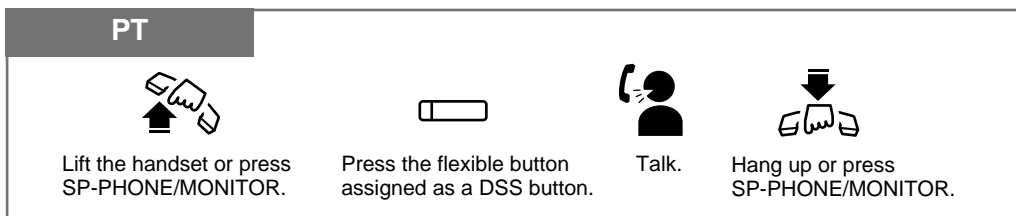

- After dialing an extension number, you will hear one of the following tones.
 - Ringback tone:** Indicates the destination extension is being called.
 - Confirmation tone:** Indicates you can perform voice calling (e.g. Paging).
 - Busy tone:** Indicates the destination extension is busy.
 - Do Not Disturb (DND) tone:** Indicates the destination extension has set the “Do Not Disturb (DND)” feature.

- PT** • An extension number and a name, if programmed, are shown on a display PT during an intercom call.
- PT** • You can assign a DSS button on a flexible button in Proprietary Telephone Settings. The stored number can be displayed by pressing the desired DSS button while on-hook.



- 1.2 Proprietary Telephone Settings, “Customizing the Buttons on Your Telephone”, DSS (Direct Station Selection) Button
- 2.1 Tone/Ring Tone List
- See the Installation Manual, Section 3, “Intercom Calling”.

1.3 Making Calls

Calling an Operator (Operator Call)

Allows you to call an operator within the system. One extension can be assigned as an operator.

Any Telephone



Lift the handset or press
SP-PHONE/MONITOR.

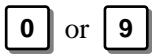

Dial 0 or 9.





- If an operator is not assigned, this feature is not available and you will hear a reorder tone.
- If the line access number is assigned to “0” by System Programming, the operator call number will be changed to “9”.
- See the Installation Manual, Section 3, “Operator Call”.

Outside Calling

Allows you to make a call to an external party using one of the following line access methods.

- 1.) Making Outside Calls Using Automatic Line Access
- 2.) Making Outside Calls Using Individual Line Access
- 3.) Making Outside Calls Using Outside (CO) Line Group Access



-  • An outside (CO) line which is not assigned to a CO button cannot be dialed.
-  • Helpful hints for the Handsfree (speakerphone) operation are noted in the “Handsfree Operation” feature.



- 1.2 Proprietary Telephone Settings, “Customizing the Buttons on Your Telephone”,
Single-CO (S-CO) Button,
Group-CO (G-CO) Button
- 1.6 Before Leaving Your Desk, “Locking Your Telephone (Electronic Station Lockout)”
- 1.7 Useful Features, “Calling with Account Codes (Account Code Entry)”
- 1.7 Useful Features, “Calling Using Your Privileges at Another Extension (Walking COS)”
- 1.8 Operator / Manager Service Features, “Remote Station Lock”
- See the Installation Manual, Section 3, “Outside Calling”.
- See the Installation Manual, Section 3, “Toll Restriction Override by Extension Password”.
- See the Installation Manual, Section 3, “Toll Restriction — Station Lock Boundary Class”.
- See the Installation Manual, Section 3, “Toll Restriction”.

1.3 Making Calls

Making Outside Calls Using Automatic Line Access

Allows you to select an available outside (CO) line automatically.

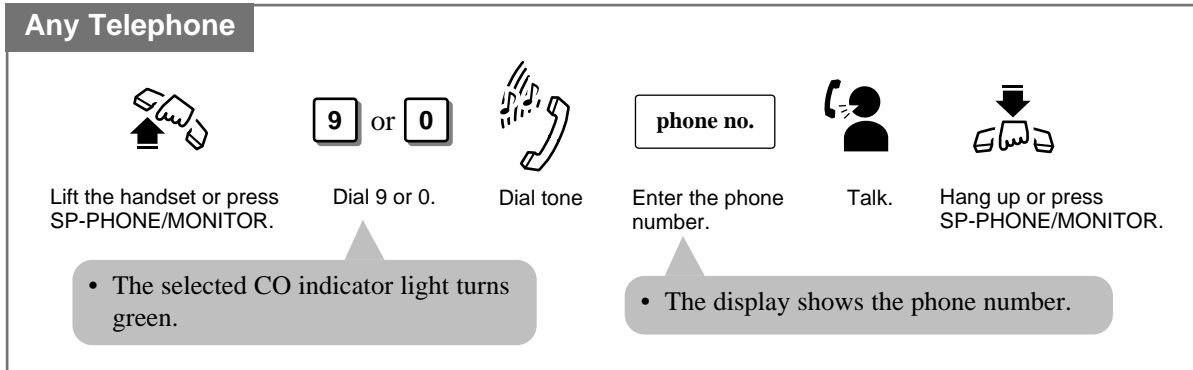

- If the line access number is assigned to “0” by System Programming, the operator call number will be changed to “9”.

Making Outside Calls Using Individual Line Access

Allows you to select the desired outside (CO) line without dialing the line access code.

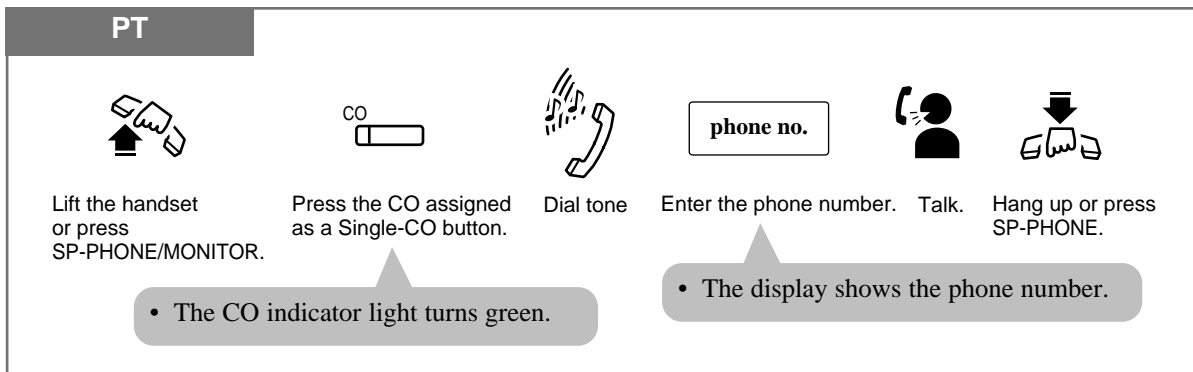

- PT** • You may skip off-hook and press the Single-CO (S-CO) button directly.

1.3 Making Calls

Making Outside Calls Using Individual Outside (CO) Line Group Access

Allows you to select an idle line within a designated outside (CO) line group.
Through System Programming, outside (CO) lines can be divided into 6 line groups.

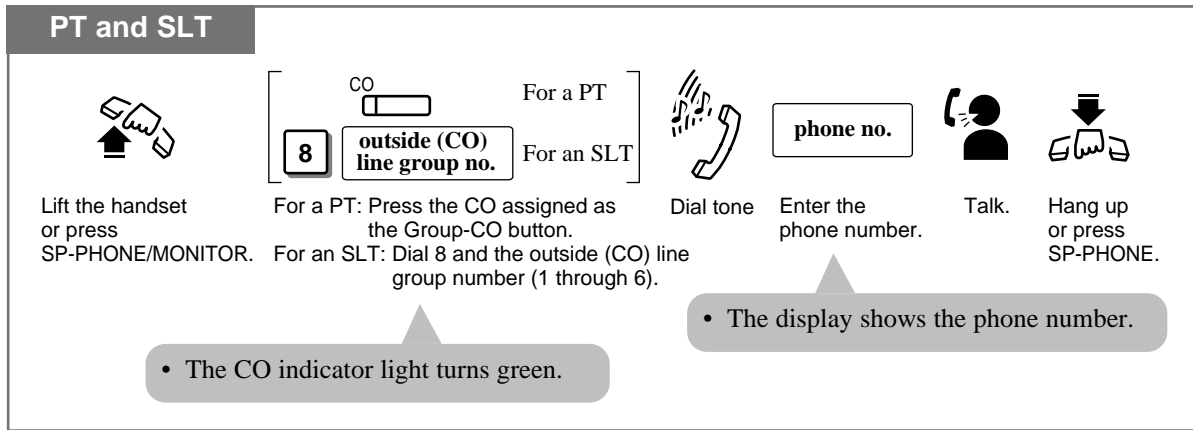

- !** PT • You may press the Group-CO button directly instead of going off-hook and dialing 8 and the outside (CO) line group number.

Flash

Allows you to disconnect the current call and make another call without hanging up.

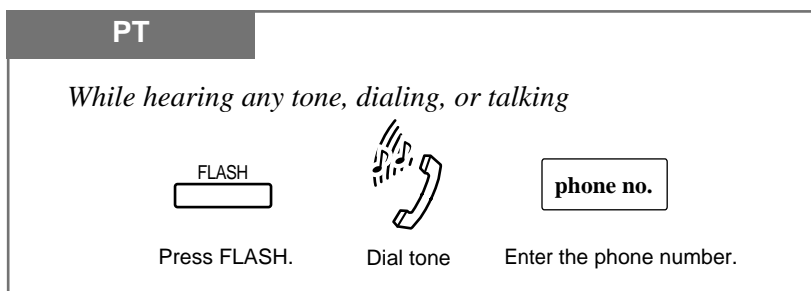

- !**
- System Programming may be required to perform this feature properly.
 - During an outside call, the FLASH button can be used as a External Feature Access button.

-  • 1.7 Useful Features, “External Feature Access”
• See the Installation Manual, Section 3, “Flash”.

1.3 Making Calls

Handsfree Operation

Allows you to dial and to talk to the other party without lifting the handset.

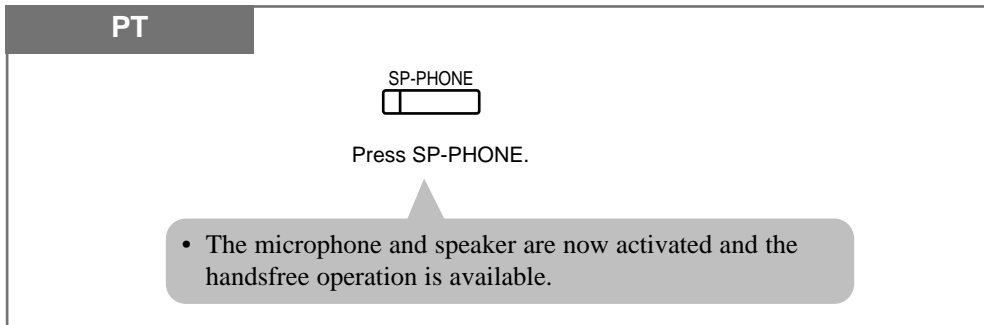

Switching from the handset to handsfree mode

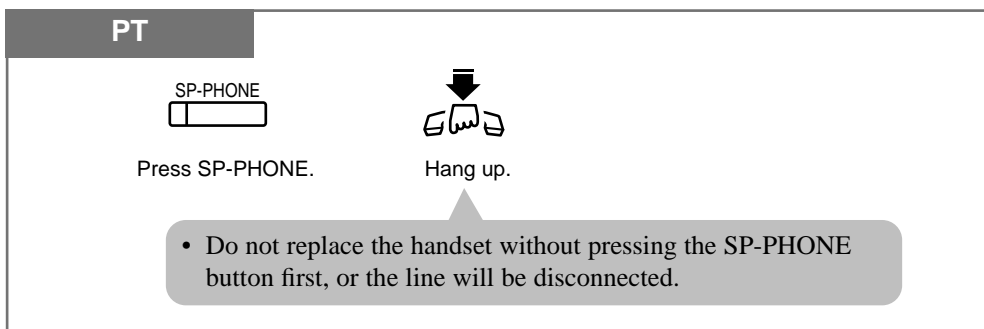

Switching from handsfree to the handset mode

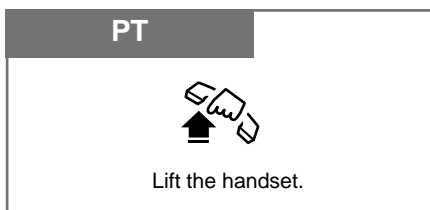

- PT • Helpful hints for the Handsfree operation:
 - Use this unit in a quiet room for best performance.
 - If you and the other party talk at the same time, parts of your conversation will be lost. To avoid this, talk alternately.
- PT • The handsfree mode is canceled if you do not start dialing within 10 seconds.
- PT • The KX-T7350/KX-T7050/KX-T7055 have MONITOR buttons instead of a SP-PHONE button. It can be used for handsfree dialing, etc., but it cannot be used for a handsfree conversation.
- PT • You can enable the handsfree mode by pressing a CO or INTERCOM button.



- See the Installation Manual, Section 3, “Handsfree Operation”.

1.3 Making Calls

Making Emergency Calls (Emergency Call)

Allows you to dial a pre-assigned emergency number after seizing an outside (CO) line. Up to 5 emergency dial numbers can be stored.

Dialing

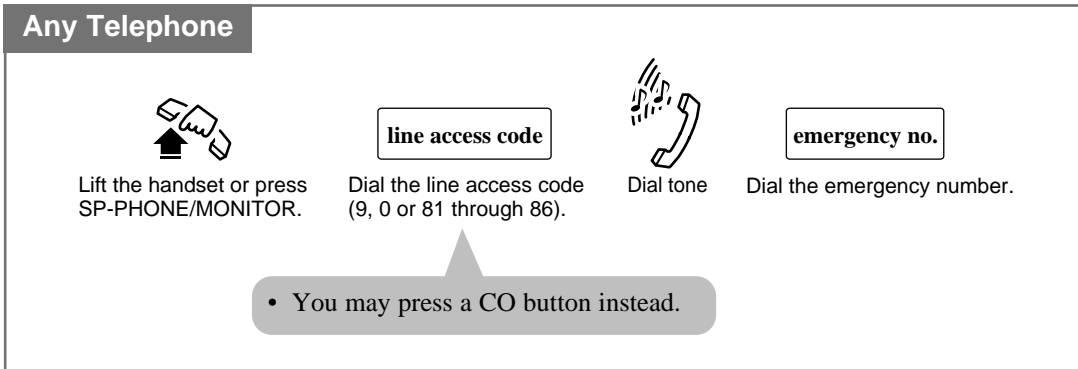

- An emergency call is allowed even in the following cases,
 - Account Code – Verify (All, Toll) modes
 - Any toll restriction COS number
 - Electronic Station Lockout
- If your telephone is connected to a host PBX, you must dial the host PBX line access code after the line access code.



- See the Installation Manual, Section 3, "Emergency Call".

1.3 Making Calls

Dialing by Simply Pressing a Button (One-Touch Dialing)

Allows you to call a number or access a system feature with the touch of a button. This is done by storing an extension number, telephone number or feature number (up to 16 digits) in a One-Touch Dialing button.

Dialing

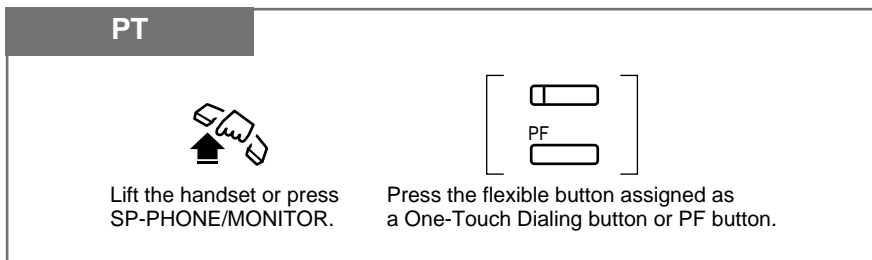

- PT** • The destination numbers are stored in Proprietary Telephone Settings.
- PT** • You may press a CO button to select a desired outside (CO) line before pressing the One-Touch Dialing button.
- PT** • “Speed Dialing”, “One-Touch Dialing” and manual dialing can be used together.
- PT** • You can store a number consisting of seventeen digits or more by dividing and storing it into 2 One-Touch Dialing buttons.
- PT** • A pause is automatically entered after the stored line access code, 9, 0 or 81 through 86, when dialing.
- PT** • To confirm the current status of the button, press the button while on-hook.



- 1.2 Proprietary Telephone Settings, “Customizing the Buttons on Your Telephone”, One-Touch Dialing Button
- See the Installation Manual, Section 3, “One-Touch Dialing”.

1.3 Making Calls

Dialing with System Speed Dialing (System Speed Dialing)

Allows you to make a call using pre-programmed speed dial numbers. This system supports 100 speed dial numbers which are available to all extension users.

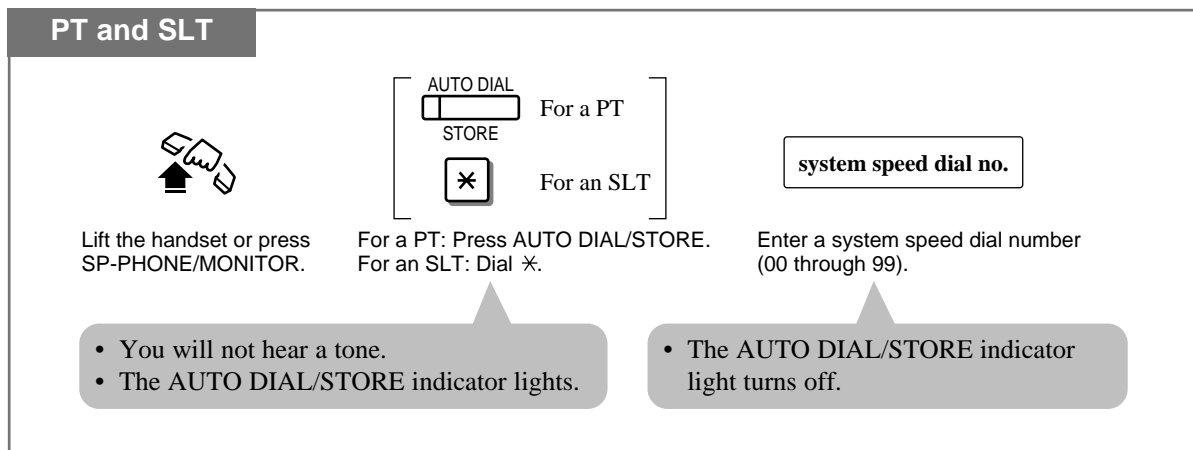

- System Speed Dial numbers must be stored by System Programming.
- “Speed Dialing”, “One-Touch Dialing” and manual dialing can be used together.
- You may press a CO button or dial a line access code to select a desired outside (CO) line before pressing the AUTO DIAL/STORE button or dialing *.
- It is possible to cancel toll restriction with this feature (Toll Restriction Override for System Speed Dialing). In this case, System Programming is necessary.

PT

- A System Speed Dial number can be divided when stored.

<Example>

If the number is divided and stored in System Speed Dial numbers 01 and 02,

Press: [AUTO DIAL/STORE] [0] [1] [AUTO DIAL/STORE] [0] [2].

PT

- The dialed number appears on the display.

SLT

- A rotary telephone cannot use this feature.



- See the Installation Manual, Section 3, “Toll Restriction for System Speed Dialing”.
- See the Installation Manual, Section 3, “System Speed Dialing”.

1.3 Making Calls

Dialing with Personal Speed Dialing (Personal Speed Dialing)

Allows you to store up to 10 speed dial numbers at your extension. These numbers are available for your extension only.

Storing a phone number

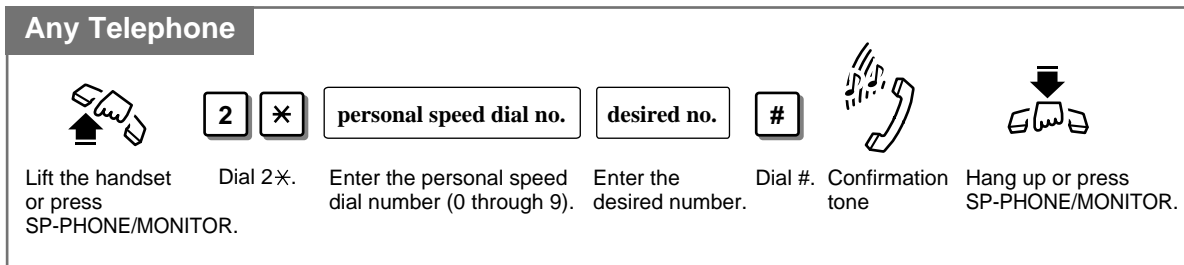

Dialing

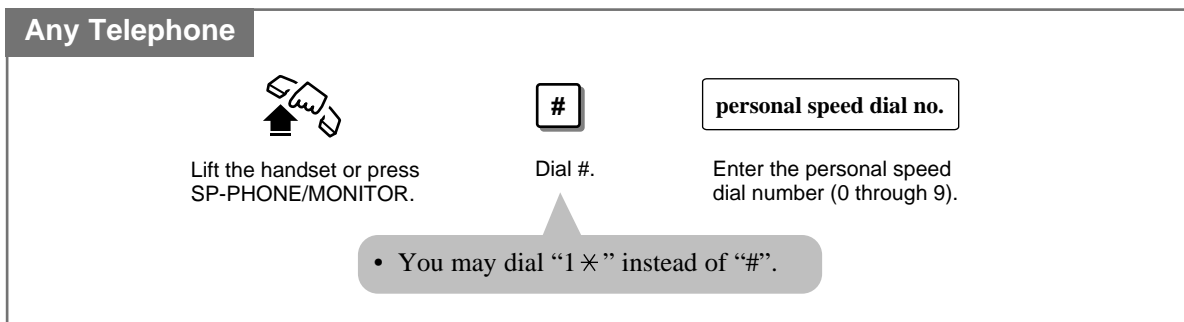

- An account code must be stored by pressing “* *” and entering the account code after the line access code.
- You can store an extension number, telephone number, or feature number of up to 16 digits. Valid digits are “0 through 9”.
- A pause can be stored by pressing the * key. However, in the account code verify-all, verify-toll and forced modes, “*” is not regarded as a pause.
- To store the telephone number of an external party, a line access code (9, 0 or 81 through 86) must be stored as the first digit.

PT

- The number of Personal Speed Dialing numbers corresponds to the number of PF buttons assigned as One-Touch Dialing. (PF buttons are on a proprietary telephone.) You cannot assign both the One-Touch Dialing and Personal Speed Dialing features to the same number. For example, if you assign One-Touch Dialing to the PF 1 button and then Personal Speed Dialing 0, only the Personal Speed Dialing 0 feature will be assigned.

SLT

- A rotary telephone cannot use this feature.







- 1.2 Proprietary Telephone Settings, “Customizing the Button on Your Telephone”, One-Touch Dialing Button
- See the Installation Manual, Section 3, “Personal Speed Dialing”.

1.3 Making Calls

Checking the stored personal speed dialing numbers

PT

 Lift the handset or press SP-PHONE/MONITOR.	 Dial 3*.	 Enter the personal speed dial number (0 through 9).	 Dial #.
---	---	--	--

1.3 Making Calls

Dialing by Simply Going Off-Hook (Pickup Dialing)

Allows you to make an outgoing call by just going off-hook (single line telephone only).

Storing a phone number

SLT

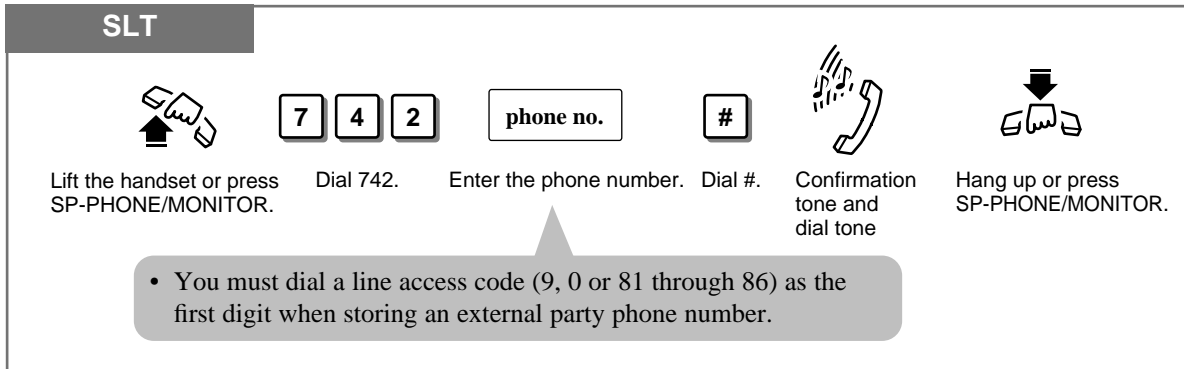

Lift the handset or press SP-PHONE/MONITOR. Dial 742. Enter the phone number. Dial #. Confirmation tone and dial tone. Hang up or press SP-PHONE/MONITOR.

- You must dial a line access code (9, 0 or 81 through 86) as the first digit when storing an external party phone number.

Setting / Canceling

SLT

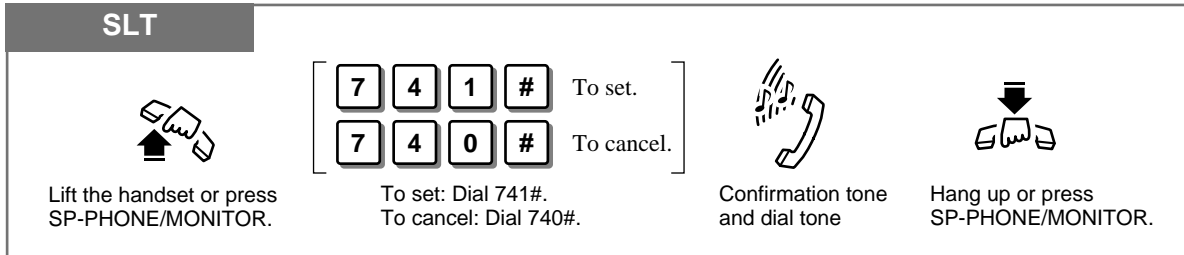

Lift the handset or press SP-PHONE/MONITOR. To set: Dial 741#. To cancel: Dial 740#. Confirmation tone and dial tone. Hang up or press SP-PHONE/MONITOR.

Dialing

SLT

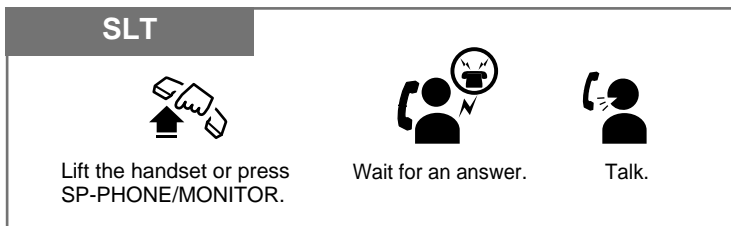

Lift the handset or press SP-PHONE/MONITOR. Wait for an answer. Talk.



- This feature will not work if you answer an incoming call or retrieve a call on hold.
- Up to 32 digits, consisting of “0 through 9” and “*”, can be stored. The “*” button is used as a PAUSE. However, in the account code verify-all, verify-toll and forced modes, “*” is not regarded as a pause.
- An account code must be stored by pressing “* *” and entering the account code after the line access code.
- During the waiting time after going off-hook, you can call another party and override this feature. You can change the waiting time between going off-hook and connecting with a called line by System Programming.
- A rotary telephone cannot use this feature.







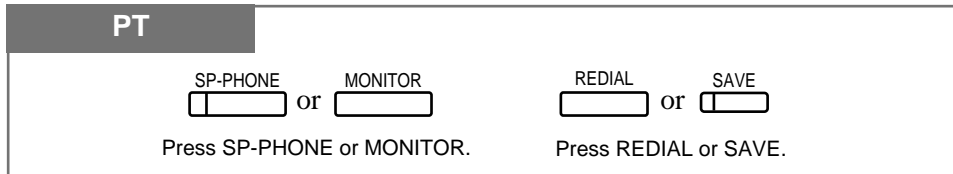

- See the Installation Manual, Section 3, “Pickup Dialing”.

1.3 Making Calls

Redialing Automatically (Automatic Redial)

PT users can redial the last number dialed and saved number automatically by going off-hook with the SP-PHONE/MONITOR button and pressing the corresponding button directly. Redial will be automatically repeated the pre-programmed number of times until the called party answers.



- !**  • The number of times can be changed by System Programming.
-  • If another operation is performed during automatic redial, this function will be canceled.
-  • To cancel automatic redial, press the FLASH button.
-  • This feature is not available for a KX-T7055.
-  • A flexible button can be assigned as the SAVE button.





- 1.3 Making Calls, “Redialing the Last Number Dialed (Last Number Redial)”
- 1.3 Making Calls, “Redialing the Saved Number (Saved Number Redial)”
- See the Installation Manual, Section 3, “Redial”.

Redialing the Last Number Dialed (Last Number Redial)

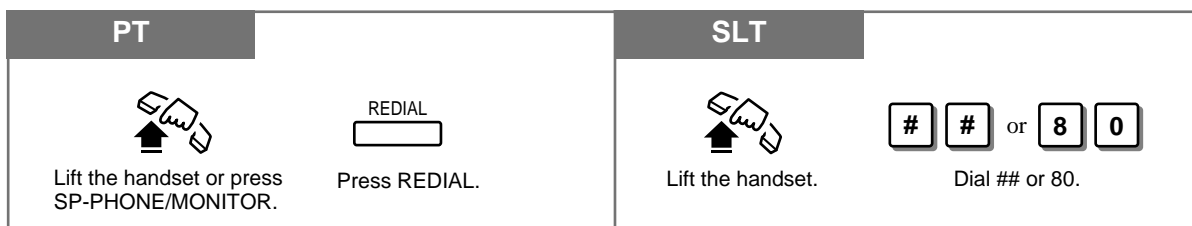
Automatically saves the last outside phone number dialed so that you can make a call to the same party later using a simple operation.



- !** • Up to 32 digits can be stored and redialed. This does not include an outside (CO) line access code.
- If you hear a busy tone when attempting to redial, select another line and press the REDIAL button or feature number.
-  • “*”, “#”, “PAUSE”, and “INTERCOM” (for secret dialing) are counted as 1 digit.
-  • While calling or during a conversation, pressing the REDIAL button will disconnect the current call and redial the stored number.
-  • You can check the stored number. Press the REDIAL button while on-hook, and the stored number will be displayed.

1.3 Making Calls



- 1.3 Making Calls, “Redialing Automatically (Automatic Redial)”
- See the Installation Manual, Section 3, “Redial”.



Redialing the Saved Number (Saved Number Redial)

Allows you to save the current external telephone number during a conversation, so that you can redial the same party later using a simple operation. The saved number can be redialed until another number is stored.

Storing



PT

During a conversation or while hearing a busy tone

	
Press AUTO DIAL/STORE.	Press SAVE.

Dialing

PT

	
Lift the handset or press SP-PHONE/MONITOR.	Press SAVE.



- PT** • Up to 32 digits can be stored and redialed. This does not include an outside (CO) line access code.
- PT** • “*”, “#”, “PAUSE”, and “INTERCOM” (for secret dialing) are counted as 1 digit.
- PT** • A flexible button can be assigned as the SAVE button.
- PT** • You can check the stored number. Press the SAVE button while on-hook, and the stored number will be displayed.
- PT** • You can change the outside (CO) line when dialing. You may press a CO button to select an outside (CO) line directly after going off-hook before pressing the SAVE button.



- 1.2 Proprietary Telephone Settings, “Customizing the Buttons on Your Telephone”, SAVE Button
- 1.3 Making Calls, “Redialing Automatically (Automatic Redial)”
- See the Installation Manual, Section 3, “Redial”.

1.3 Making Calls

Sending a Call Waiting Tone to a Busy Extension (Busy Station Signaling – BSS)

The busy extension that you called will hear the assigned Call Waiting tone and know that you are waiting.

Any Telephone

If you make an intercom call and hear a busy tone

2

Wait for an answer and talk.

Dial 2.



- To answer from the calling extension, see “Call Waiting” in this manual.
- If you hear a reorder tone when you set this feature, this feature cannot be operated with the called party. This feature is only available if the called extension has set the “Call Waiting” feature.



- 1.5 During a Conversation, “Call Waiting”
- See the Installation Manual, Section 3, “Busy Station Signaling (BSS)”.

1.3 Making Calls

Making Your Telephone Ring Back Automatically When a Line Becomes Free (Automatic Callback Busy – Camp-On)

Allows you to receive callback ringing when the dialed line becomes idle. When you answer the callback ringing;

For an extension: The called extension starts ringing without dialing.

For an outside (CO) line: The line is seized.

Setting

Any Telephone

If you hear a busy tone

 Dial 6.

 Confirmation tone and reorder tone

 Hang up or press SP-PHONE/MONITOR.

Wait for the Camp-On recall.

Answering an intercom recall

Any Telephone

If you hear the telephone ringing

 Lift the handset or press SP-PHONE/MONITOR.

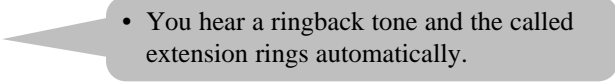
 • You hear a ringback tone and the called extension rings automatically.

Answering an outside (CO) line recall

Any Telephone

If you hear the telephone ringing

 Lift the handset or press SP-PHONE/MONITOR .

 Dial tone.

 Enter the phone number.

Canceling

Any Telephone

 Lift the handset or press SP-PHONE/MONITOR.



- If you do not answer before four callback ring signals (within 10 seconds), this feature will be canceled.



- See the Installation Manual, Section 3, “Automatic Callback Busy (Camp-On)”.

1.3 Making Calls

Interrupting an Existing Call (Executive Busy Override)

Executive Busy Override — Extension

Allows you to connect to an existing intercom (extension) call.
System Programming is required to use this feature.

Any Telephone

If you make an intercom call and while hearing a busy tone

3

Dial 3.



Confirmation tone (optional)

A three-party conference is now established.

To leave the conference

Any Telephone



Hang up or press SP-PHONE.

The other two parties continue their conversation.

To terminate one party and talk to the other

PT

CO or INTERCOM

Press the CO or INTERCOM of the party to remain connected.



Confirmation tone (optional)

- If all three parties are extensions, this operation is not available.



- This feature does not work when “Data Line Security” or “Executive Busy Override Deny” is set at either or both of the other parties.
- When a 2-party call is changed to a 3-party call or vice versa, a confirmation tone is sent to all parties. The tone can be disabled.





- 1.3 Making Calls, ‘Denying “Interrupting an Existing Call”(Executive Busy Override Deny)’
- 1.7 Useful Features, “Conference (3-party)”
- 1.7 Useful Features, “Data Line Security”
- See the Installation Manual, Section 3, “Executive Busy Override”.

1.3 Making Calls

Executive Busy Override — Outside (CO) Line

Allows you to connect to an existing outside call or add a third party to your existing conversation.



System Programming is required to use this feature.

PT		
 Lift the handset or press SP-PHONE/MONITOR.	 Press the desired CO whose indicator is lit red.	 Confirmation tone (optional)
A three-party conference is now established.		

To leave the conference

PT	
 Hang up or press SP-PHONE/MONITOR.	The other two parties continue their conversation.

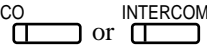
To terminate one party and talk to the other

PT	
 Press the CO or INTERCOM of the party to remain connected.	 Confirmation tone (optional)



- PT** • This feature does not work when “Data Line Security” or “Executive Busy Override Deny” is set at the extension engaged in the existing outside call.
- PT** • When a 2-party call is changed to a 3-party call or vice versa, a confirmation tone is sent to all parties. Eliminating the tone is programmable.



- 1.3 Making Calls, ‘Denying “Interrupting an Existing Call”(Executive Busy Override Deny)
- 1.7 Useful Features, “Conference (3-party)
- 1.7 Useful Features, “Data Line Security”
- See the Installation Manual, Section 3, “Executive Busy Override”.

1.3 Making Calls

Denying “Interrupting an Existing Call” (Executive Busy Override Deny)

Allows you to prevent other extension users from interrupting your conversation.

Setting / Canceling

Any Telephone

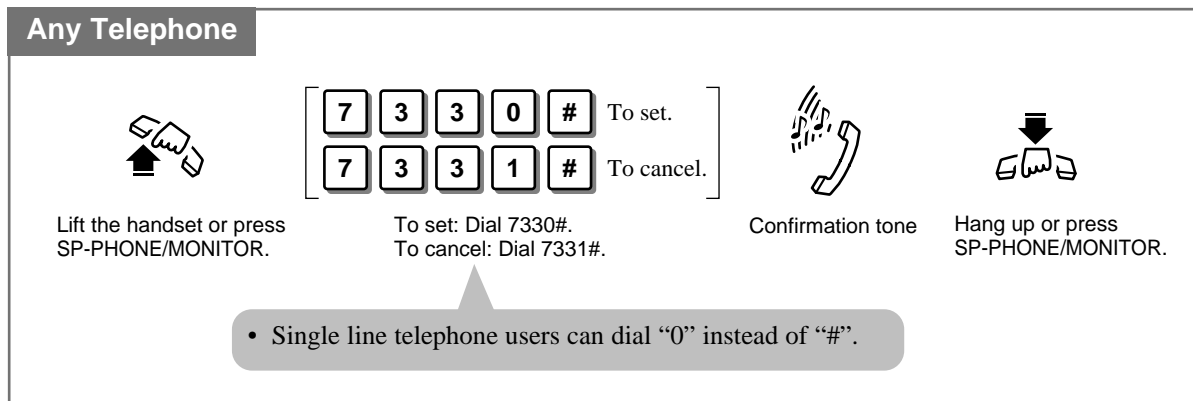

Lift the handset or press SP-PHONE/MONITOR.

7	3	3	0	#	To set.
7	3	3	1	#	To cancel.

To set: Dial 7330#.
To cancel: Dial 7331#.

Confirmation tone

Hang up or press SP-PHONE/MONITOR.

- Single line telephone users can dial “0” instead of “#”.



- 1.3 Making Calls. “Interrupting an Existing Call (Executive Busy Override)”, Executive Busy Override — Extension
- 1.3 Making Calls. “Interrupting an Existing Call (Executive Busy Override)”, Executive Busy Override — Outside (CO) Line
- See the Installation Manual, Section 3, “Executive Busy Override”.

1.4 Receiving Calls

Receiving Calls

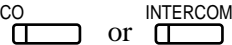
PT and SLT	PT
 <p>Lift the handset or press SP-PHONE.</p>	 <p>Press a rapid flashing CO or INTERCOM.</p> <div data-bbox="774 649 1332 739"><ul style="list-style-type: none">• The CO or INTERCOM indicator light turns steady green.</div>



- PT** • There are 3 types of Line Preference for incoming outside calls (— No Line/Prime Outside (CO) Line/Ringing Line). Each preference can be selected by Proprietary Telephone Settings.
- PT** • When receiving an incoming call, you may press the CO or INTERCOM button which is rapidly flashing red and talk (Handsfree mode).
- PT** • Helpful hints for the handsfree operation are noted in the “Handsfree Operation” feature.



- 1.2 Proprietary Telephone Settings, “Customizing Your Telephone Functions”, Preferred Line Assignment — Incoming
- 1.3 Making Calls, “Handsfree Operation”
- See the Installation Manual, Section 3, “Receiving Calls”.

1.4 Receiving Calls

Handsfree Answerback

Allows you to answer an intercom call without lifting the handset.

Setting

PT

When the SP-PHONE and the AUTO ANSWER/MUTE indicator are off

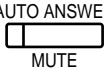

Press AUTO ANSWER/MUTE.

- The AUTO ANSWER/MUTE indicator turns on.

Canceling

PT

When the AUTO ANSWER/MUTE indicator is on

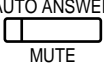

Press AUTO ANSWER/MUTE.

- The AUTO ANSWER/MUTE indicator light turns off.



- PT** • This feature does not work for incoming outside calls or doorphone calls.
- PT** • When an outside call is transferred to your extension, this feature is overridden and a ring tone is heard.



- 1.2 Proprietary Telephone Settings, “Customizing Your Telephone Functions”, Intercom Alert Assignment
- 1.7 Useful Features, “Room Monitor”
- See the Installation Manual, Section 3, “Handsfree Answerback”.

1.4 Receiving Calls

Picking up a Call Ringing at Another Extension (Call Pickup)

Directed Call Pickup

Allows you to answer an incoming call ringing at any other extension.

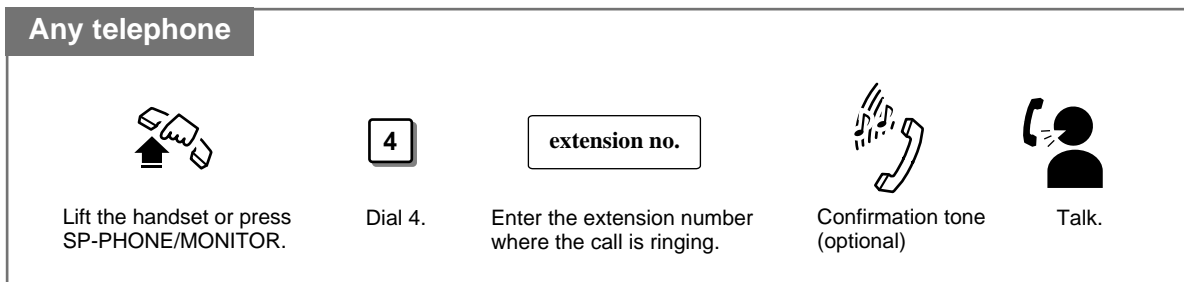

- Doorphone calls can be picked up from extensions that are not programmed to answer doorphone calls.
- You can hear a confirmation tone when the call is picked up. The tone can be disabled.
- If a ringing extension sets the Call Pickup Deny feature, you will hear a reorder tone.



- 1.4 Receiving Calls, “Picking up a Call Ringing at Another Extension (Call Pickup)”, Denying/allowing your call to be picked up (Call Pickup Deny)
- See the Installation Manual, Section 3, “Call Pickup”.

Group Call Pickup

Allows you to answer a call that is ringing at another telephone within your extension group.

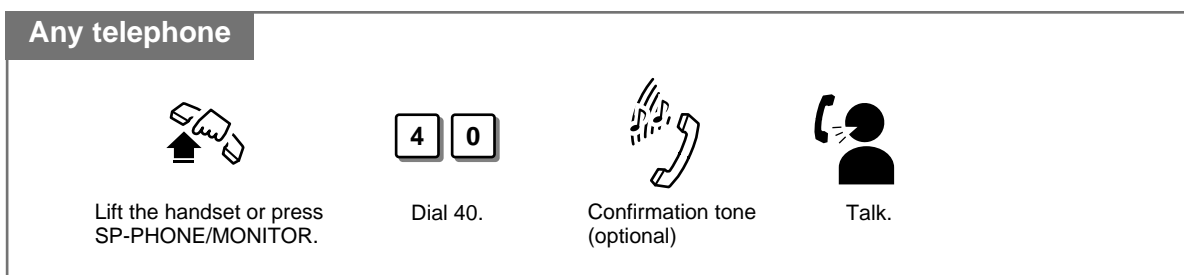

- You can pick up an incoming outside, intercom or doorphone call, but you cannot pickup a Camp-On recall and hold recall.
- You can hear a confirmation tone when the call is picked up. The tone can be disabled.
- If a ringing extension sets the Call Pickup Deny feature, you will hear a reorder tone.



- 1.4 Receiving Calls, “Picking up a Call Ringing at Another Extension (Call Pickup)”, Denying/allowing your call to be picked up (Call Pickup Deny)
- See the Installation Manual, Section 3, “Extension Group”.
- See the Installation Manual, Section 3, “Call Pickup”.

1.4 Receiving Calls

Call Retrieving from a TAM (Telephone Answering Machine)

Allows you to answer an incoming call received by a TAM.
System Programming is required to use this feature.

Any telephone

While the TAM is answering a call

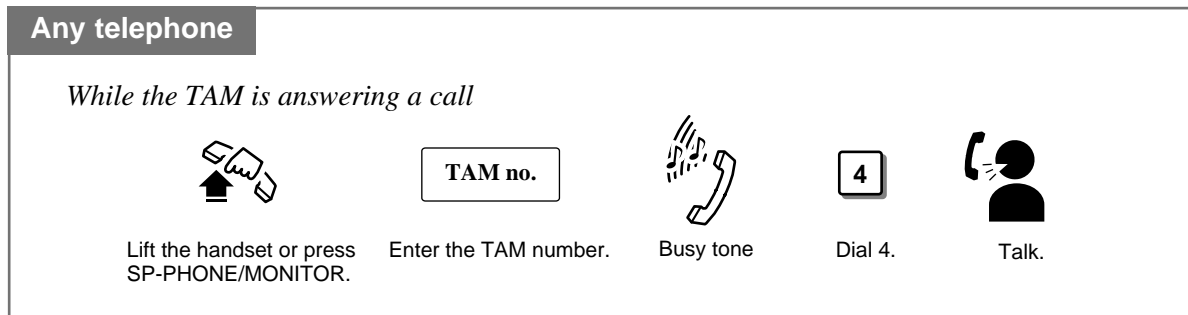

Lift the handset or press SP-PHONE/MONITOR. Enter the TAM number. Busy tone Dial 4. Talk.



- When you try to pick up a call and hear a reorder tone, the TAM is not answering the call or the dialed extension is not the TAM extension.
- A TAM number is the 3-digit extension number of the TAM.



- See the Installation Manual, Section 3, “Call Pickup”.

Denying/allowing your call to be picked up (Call Pickup Deny)

Allows you to prevent another extension from picking up your calls with the “Call Pickup” feature.

Setting / Canceling

Any Telephone

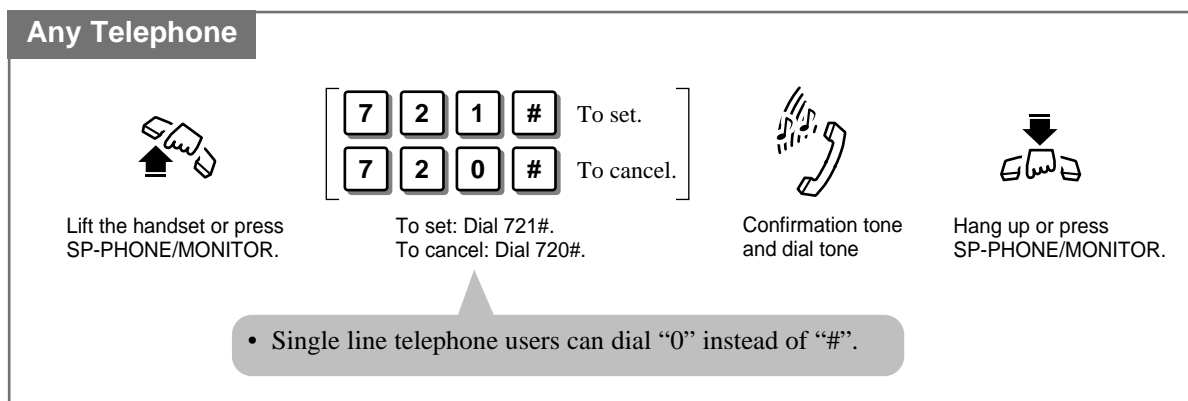

Lift the handset or press SP-PHONE/MONITOR. To set: Dial 721#. To cancel: Dial 720#. Confirmation tone and dial tone Hang up or press SP-PHONE/MONITOR.

• Single line telephone users can dial “0” instead of “#”.



- 1.4 Receiving Calls, “Picking up a Call Ringing at Another Extension (Call Pickup)”, Directed Call Pickup
- 1.4 Receiving Calls, “Picking up a Call Ringing at Another Extension (Call Pickup)”, Group Call Pickup
- See the Installation Manual, Section 3, “Call Pickup”.

1.5 During a Conversation

Placing a Call on Hold (Call Hold)

Allows you to place a call on hold.

Placing a call on hold

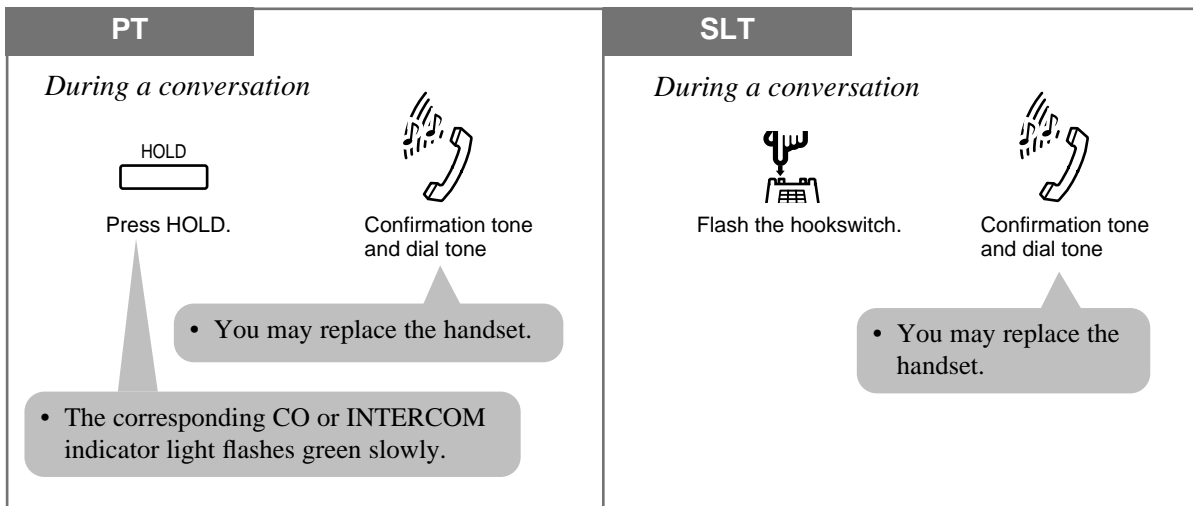

Retrieving a call on hold

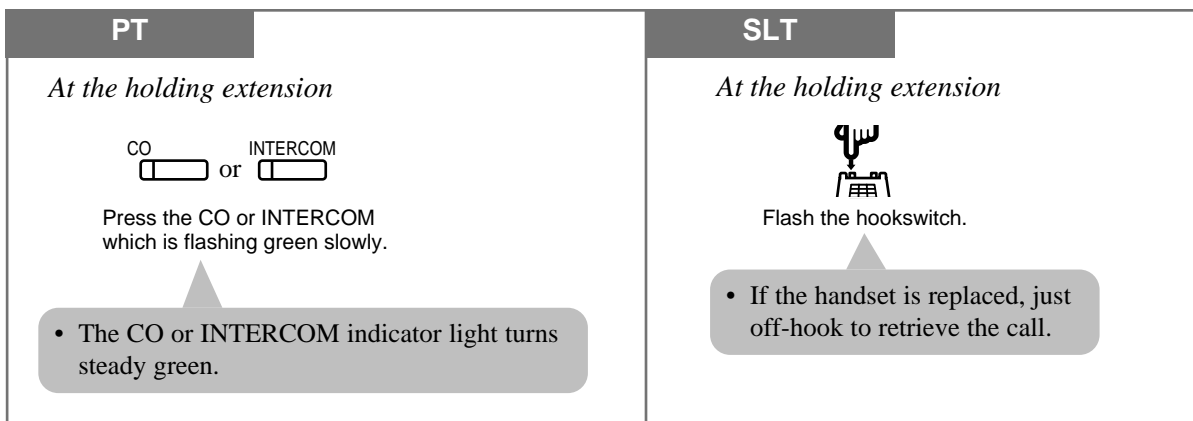

- To retrieve a call on hold at another extension, refer to “Retrieving a Call on Hold (Call Hold Retrieve)”.
- If a held call is not retrieved within a pre-determined time (default: 30 sec.), ringing or an alarm tone will be heard (Hold Alarm/Hold Recall). If the hold recall time is set to “Disable”, it will not be recalled.
- If a held outside call is not answered within 30 minutes, it will be automatically disconnected.
- When going off-hook:
 - Before recalling: A dial tone will be heard while the call is on hold. You may dial another telephone number.
 - While recalling: Only the first call on hold will be released and enter the conversation mode.
- You cannot hold a doorphone call.

1.5 During a Conversation

- PT** • During a 5-party conference, you cannot use this feature.
- PT** • With outside calls, you can put multiple calls on hold. However, with intercom calls, you can put only one call on hold.
- PT** • If a call is placed on hold for more than the programmed time, ringing or an alarm tone will be heard (Hold Alarm/Hold Recall) and the LCD will flash the following display.
Example:
 - When holding extension 111, Mr. Brown: “111: Brown” will flash.
 - When holding outside (CO) line, CO 1: “Call on CO 1” will flash.
- SLT** • If “Hold-2” or “Hold-3” is assigned by System Programming, you must dial “20” after flashing the hookswitch.
- SLT** • Only an outside or intercom call can be placed on hold at one time. If you want to hold both calls, use the Call Park feature.



- 1.5 During a Conversation, “Retrieving a Call on Hold (Call Hold Retrieve)”
- 1.5 During a Conversation, “Placing a Call in System Parking Area (Call Park)”
- 1.7 Useful Features, “Conference (5-party)”
- See the Installation Manual, Section 3, “Hold”.

Placing a Call on Hold Exclusively (Exclusive Hold)

Prevents other extension users from retrieving your held call. Only the user who held the call can retrieve it.

Placing a call on exclusive hold

PT

During a conversation

HOLD

Press HOLD.

HOLD

Press HOLD again.

- The CO or INTERCOM indicator light flashes green slowly.
- The current call is placed on hold.

- The CO or INTERCOM indicator light flashes green moderately.
- The current call is placed on exclusive hold.

Retrieving a call on exclusive hold

PT

CO or INTERCOM

Press the CO or INTERCOM which is on exclusive hold.

- The CO or INTERCOM indicator light turns steady green.
- The held call is released.

1.5 During a Conversation

- !** PT • During a 5-party conference, you cannot use this feature.
- PT • If a held call is not retrieved within a pre-determined time (default: 30 sec.), ringing will be heard (Hold Recall).
- PT • If an outside call is placed on hold and not retrieved within 30 minutes, it will be automatically disconnected.
- PT • With outside calls, you can put multiple calls on exclusive hold. However, with intercom calls, you can put only one call on exclusive hold.





- 1.5 During a Conversation, “Placing a Call on Hold (Call Hold)”
- 1.7 Useful Features, “Conference (5-party)”
- See the Installation Manual, Section 3, “Hold”.



Retrieving a Call on Hold (Call Hold Retrieve)

Allows you to retrieve a call that has been placed on hold by another extension.

Retrieving an outside call on hold

PT and SLT	PT
<p><i>At the other extension</i></p> <div style="display: flex; justify-content: space-around; align-items: center;"> <div style="text-align: center;">  Lift the handset or press SP-PHONE/MONITOR. </div> <div style="text-align: center;"> <div style="border: 1px solid black; padding: 2px 5px;">5</div> <div style="border: 1px solid black; padding: 2px 5px;">3</div> Dial 53. </div> <div style="text-align: center;"> <div style="border: 1px solid black; padding: 2px 5px;">outside (CO) line no.</div> Enter the held outside (CO) line number (1 through 6). </div> <div style="text-align: center;">  Confirmation tone </div> </div>	<p><i>At the other extension</i></p> <div style="text-align: center;"> <div style="border: 1px solid black; padding: 2px 5px;">CO</div>  Press the CO whose indicator is flashing red slowly. </div> <div style="background-color: #cccccc; border: 1px solid black; padding: 5px; margin-top: 10px;"> <ul style="list-style-type: none"> The CO indicator light turns steady green. </div>

Retrieving an intercom call on hold

PT and SLT
<p><i>At the other extension</i></p> <div style="display: flex; justify-content: space-around; align-items: center;"> <div style="text-align: center;">  Lift the handset or press SP-PHONE/MONITOR. </div> <div style="text-align: center;"> <div style="border: 1px solid black; padding: 2px 5px;">5</div> Dial 5. </div> <div style="text-align: center;"> <div style="border: 1px solid black; padding: 2px 5px;">extension no.</div> Enter the holding extension number (100 through 199). </div> <div style="text-align: center;">  Confirmation tone </div> </div>

- !** • “Call Park” and “Exclusive Hold” cannot be retrieved by this feature.
- You can hear a confirmation tone when the call is retrieved by entering the feature number.



- 1.5 During a Conversation, “Placing a Call on Hold (Call Hold)”
- See the Installation Manual, Section 3, “Hold”.

1.5 During a Conversation

Placing a Call in System Parking Area (Call Park)

Allows you to place a held call into a system parking area. You can release from the parked call to perform other operations. The parked call can be retrieved by any extension user. Up to 10 calls can be parked.

PT and SLT

During a conversation

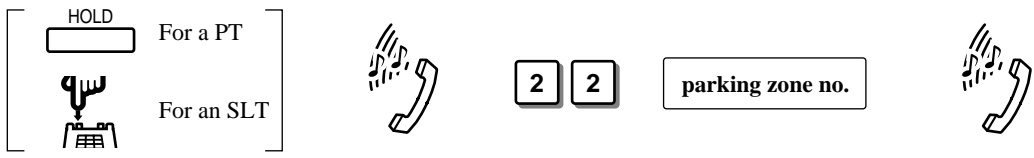

For a PT: Press HOLD.
For an SLT: Flash the hookswitch.

Confirmation tone and dial tone

Dial 22.

Enter a parking zone number (0 through 9).

Confirmation tone and dial tone

- If you hear a busy tone, it indicates the specified parking zone is unavailable.
- You do not need to redial the feature number to change the parking zone. Just enter the parking zone number while hearing the busy tone.

Retrieving a parked call

PT and SLT

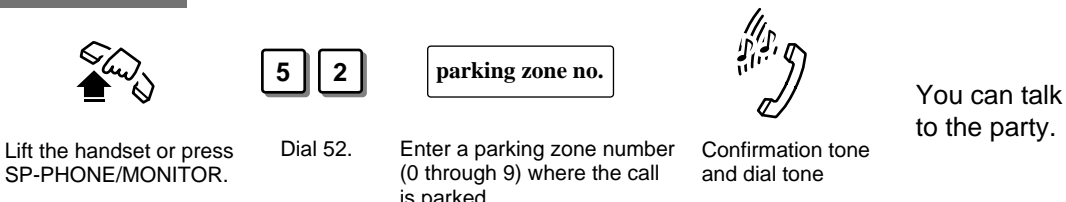

Lift the handset or press SP-PHONE/MONITOR.

Dial 52.

Enter a parking zone number (0 through 9) where the call is parked.

Confirmation tone and dial tone

You can talk to the party.

- If there is no held call, you will hear a reorder tone.



- If a parked call is not retrieved within a pre-determined time (default: 30 seconds), ringing will be heard (Hold Recall).
 - If a parked call is not retrieved within 30 minutes, it will be automatically disconnected.
 - This feature is useful when you want to hold more than one intercom call with a PT, or more than one intercom or outside call with an SLT.
- PT**
- During a 5-party conference, you cannot use this feature.



- 1.7 Useful Features, “Conference (5-party)”
- See the Installation Manual, Section 3, “Call Park”.

1.5 During a Conversation

Transferring a Call to an Extension (Call Transfer – to Extension)

Allows you to transfer a received call to another extension. There are 2 ways.

Screened Call Transfer: The destination confirms the transfer before sending.

Unscreened Call Transfer: The line is released after transferring the call without confirmation.

Screened Call Transfer

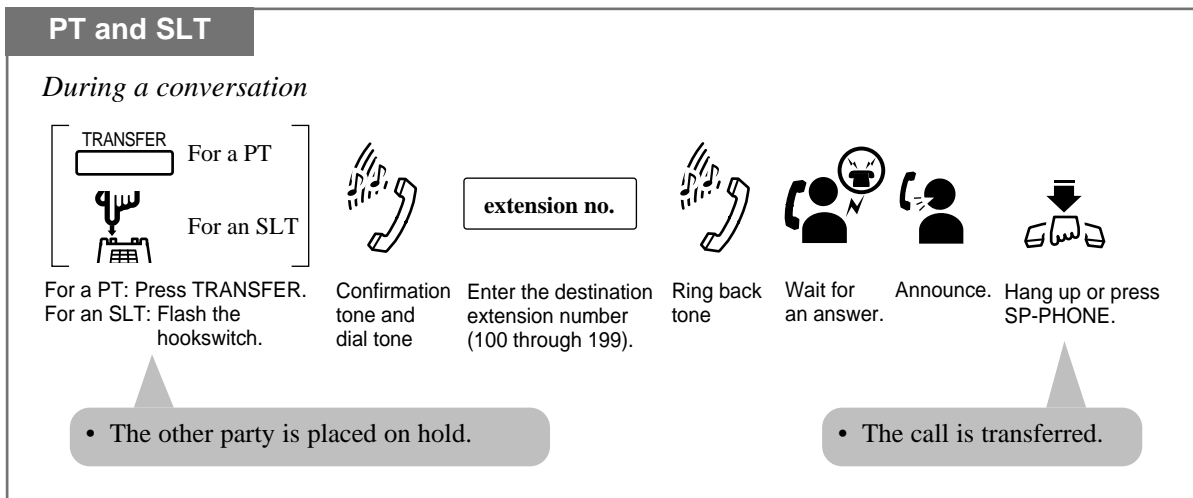

Unscreened Call Transfer

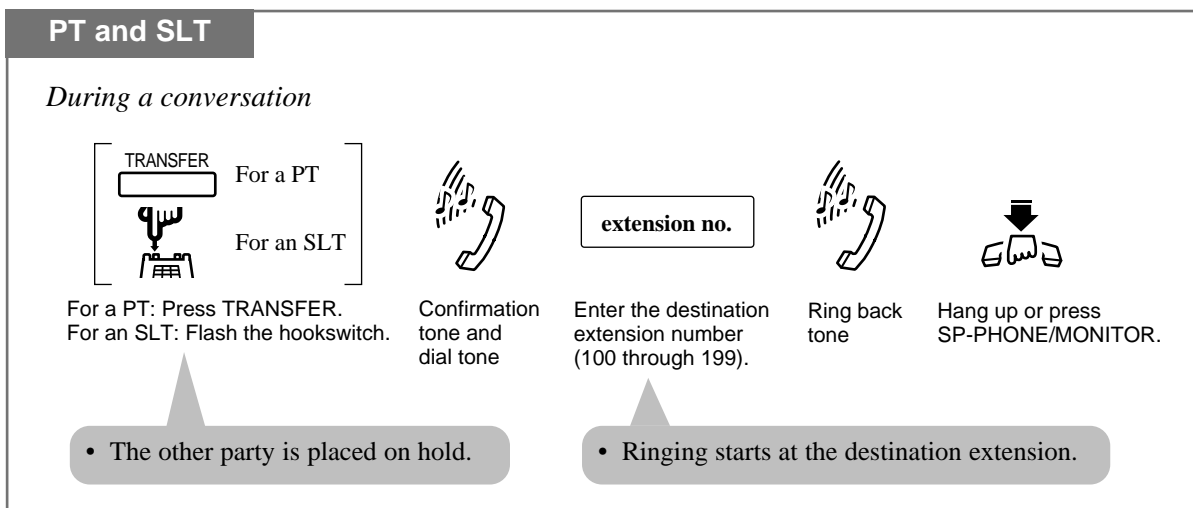

1.5 During a Conversation

Call Transfer using a DSS button

Allows you to perform a Screened or Unscreened Call Transfer by using a DSS button. There are 2 operations, depending on whether or not One-Touch Transfer* is set.

* **One-Touch Transfer** allows you to hold an outside call and transfer it to an extension by pressing one key. This feature provides automatic hold and transfer, without pressing the TRANSFER button. System Programming is required to use this function.

“With Transfer” mode

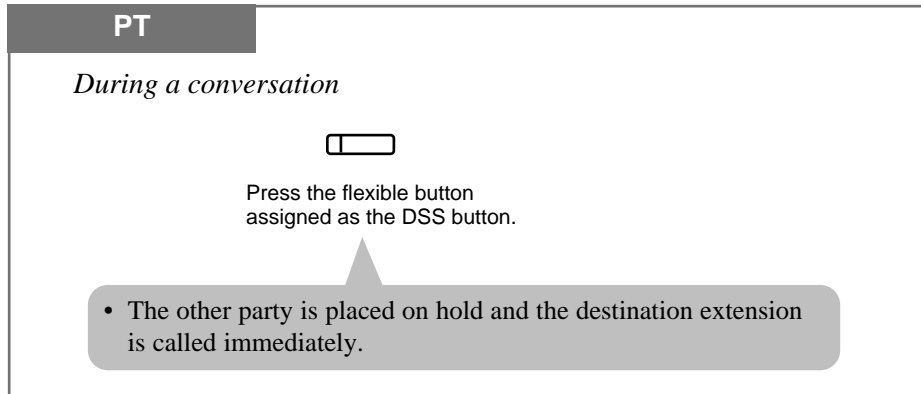

“Without Transfer” mode

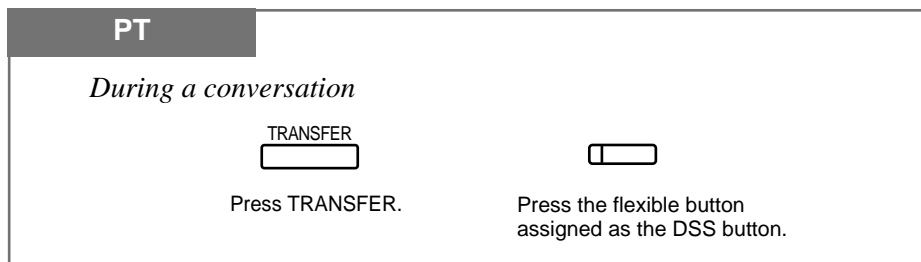

- If the destination extension does not answer the call within a pre-determined time (default: 30 sec.), the call will return to you (Transfer Recall).
- If there is no answer within 30 minutes after “Transfer Recall” starts, the line will be disconnected.
- When the dialed extension is busy, you may access the extension by dialing “2” (Busy Station Signaling) or “3” (Executive Busy Override) and going on-hook.

- PT** • If you want to return to the held call, press the TRANSFER button or corresponding CO or INTERCOM button before the destination extension answers.
- PT** • A flexible CO button can be assigned as a DSS button.
- PT** • To use “One-Touch Transfer”, System Programming is required.
- PT** • During a 5-party conference, you cannot transfer a call.
- SLT** • If you want to return to the held call, flash the hookswitch before the destination extension answers.
- SLT** • If “Hold-3” is assigned in System Programming, you must dial “20” after flashing the hookswitch.



- 1.2 Proprietary Telephone Settings, “Customizing the Buttons on Your Telephone”, DSS (Direct Station Selection) Button
- See the Installation Manual, Section 3, “Call Transfer – to Extension”.

1.5 During a Conversation

Transferring a Call to an Outside (CO) Line (Call Transfer – to Outside (CO) Line)

Allows you to transfer a received call to an external party.
System Programming is required to execute this feature.

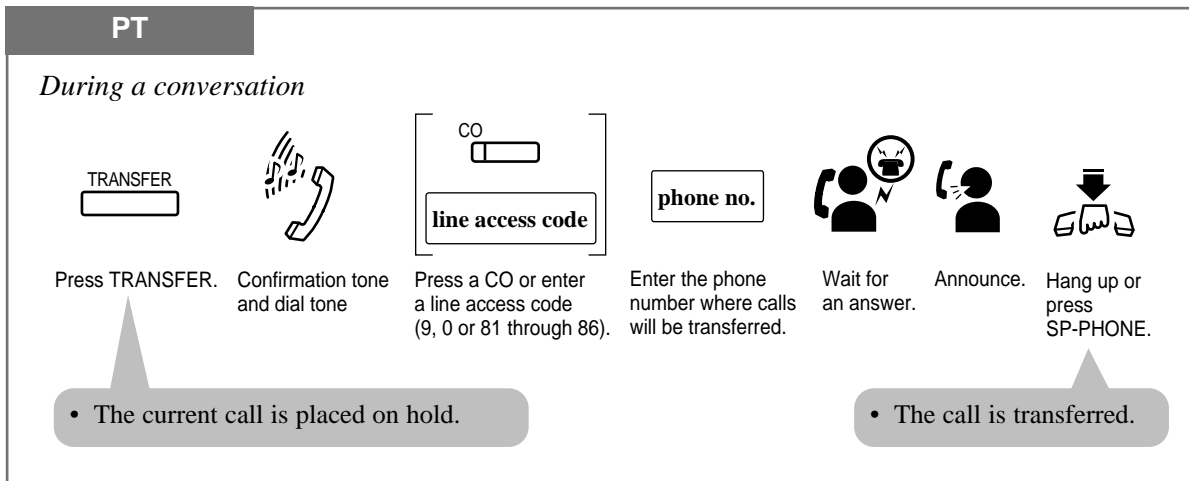

- !** **PT** • If a CPC or reverse signal is sent to an outside (CO) line before the assigned time limit, a call between two external parties will be disconnected.
- PT** • If a call between two external parties is established, an alarm tone is sent to both parties 15 seconds before the assigned time limit (default: 10 min.). “Hold Recall” is sent to the transferring extension 50 seconds before time out.
- PT** • If you want to return to the held call, press the TRANSFER button or corresponding CO or INTERCOM button before the destination party answers.
- PT** • If you want to join the conversation after transferring the call, press the corresponding CO button. A conference call is established.
- PT** • To change the party where the call is transferred before hanging-up, press the CO button whose indicator is flashing slowly to retrieve the call, then repeat the Call Transfer procedure.



- See the Installation Manual, Section 3, “Call Transfer – to Outside (CO) Line”.

1.5 During a Conversation

Call Waiting

During a conversation, a Call Waiting tone informs you that there is a call waiting. You can answer the second call by disconnecting the first call or placing it on hold.

Setting / Canceling for outside calls

Any Telephone



Lift the handset or press SP-PHONE/MONITOR.

7	3	1	1	#
To set.				
7	3	1	0	#
To cancel.				

To set: Dial 7311#.
To cancel: Dial 7310#.



Confirmation tone and dial tone



Hang up or press SP-PHONE/MONITOR.

- Single line telephone users can dial “0” instead of “#”.

Setting / Canceling for intercom calls

Any Telephone



Lift the handset or press SP-PHONE/MONITOR.

7	3	2	1	#
To set.				
7	3	2	0	#
To cancel.				

To set: Dial 7321#.
To cancel: Dial 7320#.







Confirmation tone and dial tone



Hang up or press SP-PHONE/MONITOR.

- Single line telephone users can dial “0” instead of “#”.

To talk to the new caller by terminating the current call

PT	SLT
<p><i>While hearing a Call Waiting tone</i></p> <div style="display: flex; justify-content: space-around; align-items: center;"> <div style="text-align: center;"> <p>CO <input type="checkbox"/> or INTERCOM <input type="checkbox"/></p> <p>Press the flashing CO or INTERCOM.</p> </div> <div style="text-align: center;">  <p>Talk to the new caller.</p> </div> </div> <div style="text-align: center; margin-top: 10px;"> <ul style="list-style-type: none"> • The current call is disconnected. </div>	<p><i>While hearing a Call Waiting tone</i></p> <div style="display: flex; justify-content: space-around; align-items: center;"> <div style="text-align: center;">  <p>Hang up.</p> </div> <div style="text-align: center;">  <p>Lift the handset.</p> </div> <div style="text-align: center;">  <p>Talk to the new caller.</p> </div> </div> <div style="text-align: center; margin-top: 10px;"> <ul style="list-style-type: none"> • The current call is disconnected. </div>

1.5 During a Conversation

To talk to the new party by holding the current call

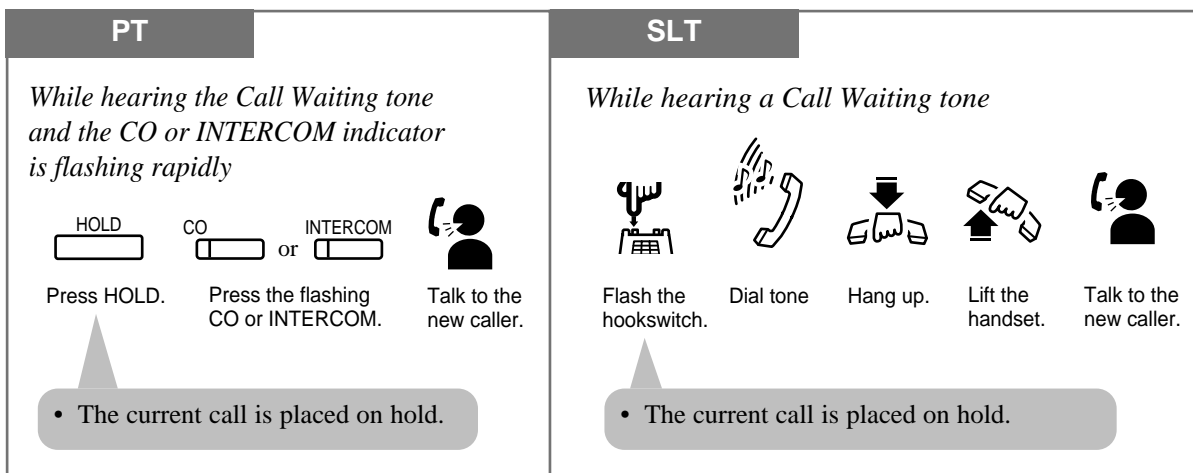

— If both the current call and new call are extension calls, you do not have to press the INTERCOM button.



- The default is “OFF”.
- When Call Waiting is enabled, a Call Waiting tone is sent to the user under the following conditions.
 - When an outside call (except a doorphone call) is received, or
 - When another extension executes the “Busy Station Signaling (BSS)” feature.

Setting “Data Line Security” temporarily cancels this feature.

You can change the desired Call Waiting tone (Tone 1 or Tone 2).

PT • If a Call Waiting tone is heard and the CO or INTERCOM indicator does not flash, this tone indicates Call Waiting from the Central Office. In this case, see “External Feature Access”.

SLT • If “Hold-2” or “Hold-3” is assigned in System Programming, you must dial “20” after flashing the hookswitch.

SLT • You cannot transfer the new call while holding the current call. If you want to do so, first park call the original call using the Call Park feature; then hang up; then take the new call.



- 1.2 Proprietary Telephone Settings, “Customizing Your Telephone Functions”, Call Waiting Tone Selection
- 1.3 Making Calls, “Sending a Call Waiting Tone to a Busy Extension (Busy Station Signaling – BSS)”
- 1.5 During a Conversation, “Placing a Call in System Parking Area (Call Park)”
- 1.7 Useful Features, “Data Line Security”
- 1.7 Useful Features, “External Feature Access”
- See the Installation Manual, Section 3, “Call Waiting”.

1.5 During a Conversation



Call Splitting

Allows you to talk to two different parties alternately. If a call is received while you are already on the line, you can place the current call on hold and have a conversation with the other party.

Having a conversation while another call is on (exclusive) hold



PT

Between one extension and one outside line

  or 
Press HOLD. Press CO or INTERCOM.

- Repeating these operations (steps 1 and 2) alternates between the callers.

Between two outside lines

 
Press HOLD. Press CO.

- Repeating these operations (steps 1 and 2) alternates between the callers.

Between two extensions

Press HOLD.

- Pressing the HOLD button alternates between the callers.

SLT

Flash the hookswitch.

- The first held call is released.
- Flashing this switch alternates between the callers.



PT

- This feature does not work during a doorphone call or paging.
- During a 5-party conference, you cannot use this feature.



- 1.5 During a Conversation, “Placing a Call on Hold (Call Hold)”
- 1.5 During a Conversation, “Placing a Call on Hold Exclusively (Exclusive Hold)”
- See the Installation Manual, Section 3, “Call Splitting”.

1.5 During a Conversation

Paging

Allows you to make a voice announcement to several people at the same time. Your message is announced over built-in speakers of proprietary telephones and/or the external pager. The paged person can answer your page from any telephone. You can also transfer a call after paging or denying to be paged.

All extensions

Allows you to make a voice announcement to all extensions.

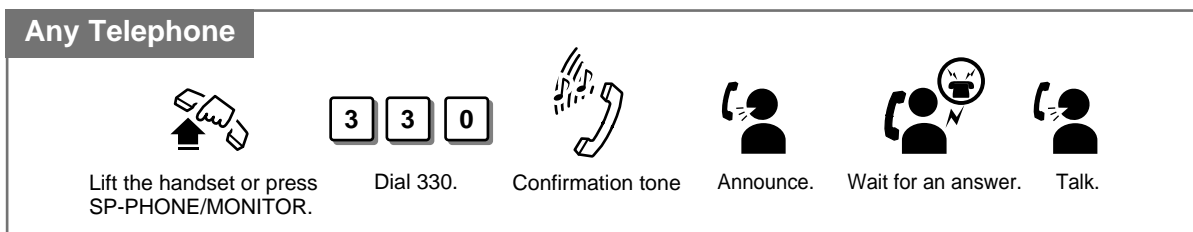

Group

Allows you to select an extension group and make a voice announcement. The announcement can only be heard through the extensions' built-in speakers.

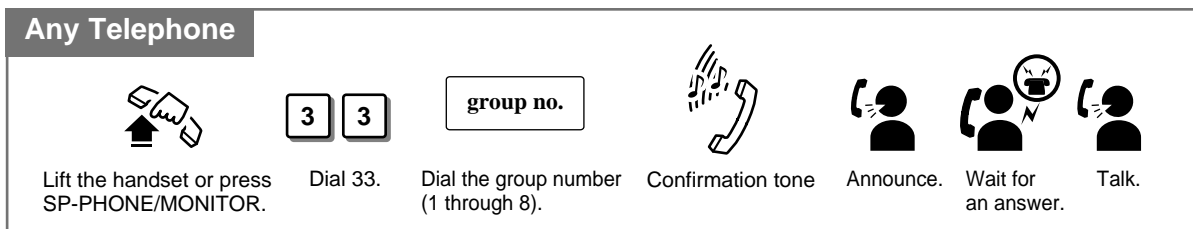

External

Allows you to make a voice announcement over the external pager.

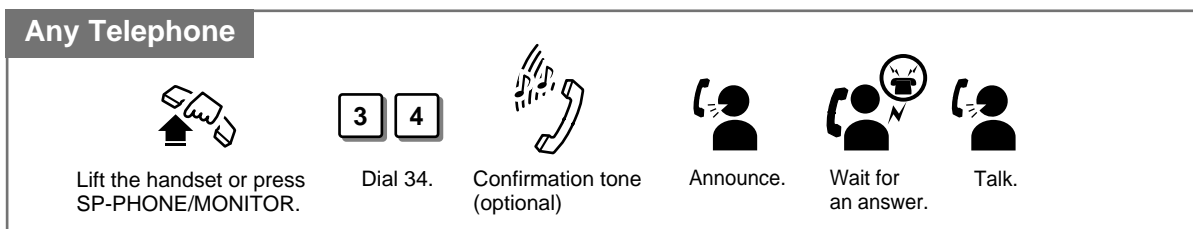

1.5 During a Conversation

All extensions & External

Allows you to make a voice announcement to all extensions. Your message is announced over the built-in speakers of proprietary telephones (PT) and the external pager.

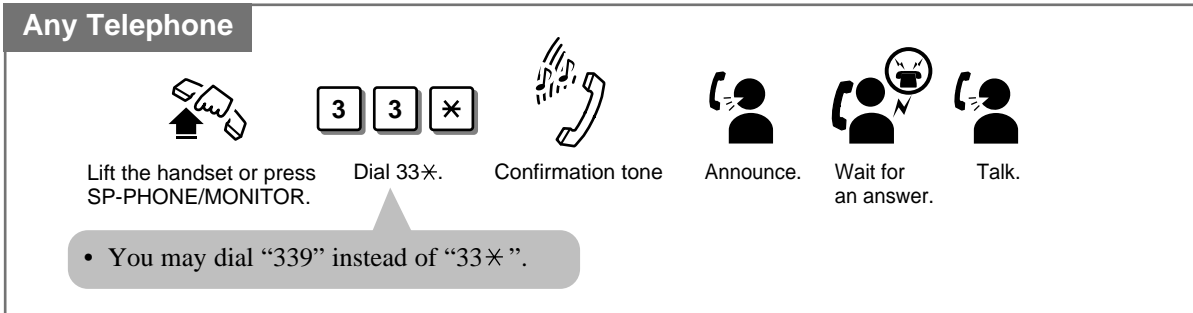

- If the pager is in use, a busy tone will be heard.
- The paged extension users hear a confirmation tone before the voice announcement.
- You can hear a confirmation tone from the external pager (External Pager Confirmation Tone) at the paged side before the voice announcement. The tone can be disabled.
- You can hear a confirmation tone before making the voice announcement.
- More than one person cannot use the paging feature at the same time.
- You cannot page extensions which have set the DND or Paging-Deny feature, or which are in use.



- 1.7 Useful Features, “Rejecting Incoming Calls (Do Not Disturb — DND)”
- See the Installation Manual, Section 3, “Paging”.

Answering a Page

Allows you to answer an announced page at any extension within the system.

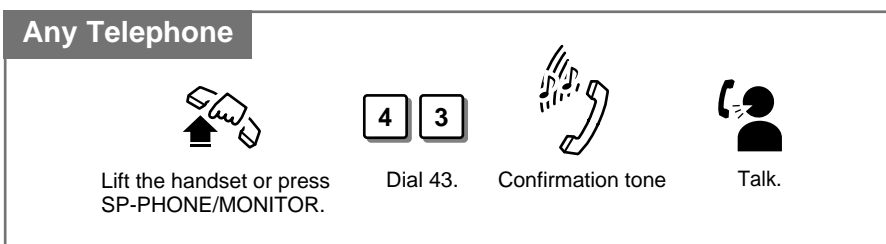

PT

- You can hear a confirmation tone when the page is answered.
- If an outside call has been paged and transferred, you can answer the call by pressing the corresponding CO button whose indicator is flashing slowly.



1.5 During a Conversation

Transferring after paging (Paging and Transfer)

You can transfer a call using the paging function (All Extensions, Group, External, or All Extensions & External).

PT and SLT

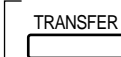
During a conversation

 For a PT
 For an SLT





Dial tone

3	3	0	For all extensions.
3	3	group no.	For a group.
3	4		For external.
3	3	*	For all extensions & external.

For all extensions: Dial 330.
 For an extension group: Dial 331 through 338.
 For external: Dial 34
 For all extensions & external: Dial 33* or 339.

- The other party is placed on hold.
- You may dial “339” instead of “33*”.

 Confirmation tone

 Announce.

 Wait for an answer.

 Confirmation tone

 Hang up or press
 SP-PHONE/MONITOR.

- The held party and the paged extension are connected and can start a conversation.



- If the external paging access tone is set to “Disable”, a confirmation tone from the external paging equipment will not be heard after accessing external paging. Refer to System Programming, “External Paging Access Tone”.

SLT



- If “Hold-3” is assigned in System Programming, you must dial “20” after flashing the hookswitch.

1.5 During a Conversation

Paging Deny

A page sent to a built-in speaker can be denied by any extension in the system.

Setting / Canceling

PT														
	<div style="border: 1px solid black; padding: 5px; display: inline-block;"> <table border="1" style="border-collapse: collapse;"> <tr> <td style="padding: 2px 10px;">7</td> <td style="padding: 2px 10px;">3</td> <td style="padding: 2px 10px;">4</td> <td style="padding: 2px 10px;">1</td> <td style="padding: 2px 10px;">#</td> <td style="padding: 0 10px;">To set.</td> </tr> <tr> <td style="padding: 2px 10px;">7</td> <td style="padding: 2px 10px;">3</td> <td style="padding: 2px 10px;">4</td> <td style="padding: 2px 10px;">0</td> <td style="padding: 2px 10px;">#</td> <td style="padding: 0 10px;">To cancel.</td> </tr> </table> </div>	7	3	4	1	#	To set.	7	3	4	0	#	To cancel.	
7	3	4	1	#	To set.									
7	3	4	0	#	To cancel.									
Lift the handset or press SP-PHONE/MONITOR.	To set: Dial 7341#. To cancel: Dial 7340#.	Hang up or press SP-PHONE/MONITOR.												

Turning off the Microphone (Microphone Mute)

Allows you to turn off the microphone so you can consult privately with others in the room. You will still be able to hear the other party.

Setting

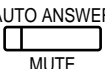
PT	
<i>During a conversation in the handsfree mode</i>	
	<ul style="list-style-type: none"> The AUTO ANSWER/MUTE indicator light flashes red slowly.
Press AUTO ANSWER/MUTE.	

Canceling

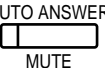
PT	
<i>When microphone mute is established</i>	
	<ul style="list-style-type: none"> The AUTO ANSWER/MUTE indicator light turns off.
Press AUTO ANSWER/MUTE.	



PT • This feature is only available during a handsfree conversation.



• See the Installation Manual, Section 3, “Microphone Mute”.

1.6 Before Leaving Your Desk

Forwarding a Call (Call Forwarding)

Automatically transfers incoming calls to another extension or to an external destination. The following types are available.

TYPE	DESCRIPTION
All Calls	All incoming calls are forwarded to another extension.
Busy or No Answer	All incoming calls are forwarded to another extension when you do not answer or when your extension is busy.
To Outside (CO) Line	All incoming calls are forwarded to an outside (CO) line.
Follow Me	Allows you to set “Call Forwarding — All Calls” feature from another extension.

Note: You can also set Voice Mail as the forwarding destination. Refer to “Voice Mail Integration” in this manual.



- To cancel the Call Forwarding features, refer to “Cancel” in this feature.
- Call Forwarding can only be extended to one target telephone. For example, extension A is forwarded to extension B, and if extension B tries to set Call Forwarding to extension C, an alarm tone is heard and the setting is rejected. If extension B has already set Call Forwarding to extension C, and extension A tries to set Call Forwarding to extension B, the setting will be also rejected.



- If the destination extension has already set “Do Not Disturb”, you cannot forward any calls to the extension.
- There should be at least one extension that can receive calls in the same UCD group.
- When a UCD extension which sets “Call Forwarding” function receives a call, the call will not be forwarded and the system will search for an idle extension in the UCD group first. But if the UCD extension is the last one that can receive the call, it will be forwarded to the assigned extension by “Call Forwarding”.
- Setting a new “Call Forwarding” function (All Calls, Busy or No Answer, etc.) cancels any other “Call Forwarding” functions or the “Do Not Disturb (DND)” function.
- If your entry is valid, confirmation tone 1 (1 beep) is sent. If your entry is the same as previously programmed data, confirmation tone 2 (2 beeps) is sent. Refer to the “Tone List” in the Appendix (Section 2).
- You can call the original extension from the Call Forwarding destination extension (for example, Boss Secretary).
- Camp-On recall and Hold recall are not forwarded.

1.6 Before Leaving Your Desk

- PT** • A flexible CO button on a proprietary telephone which is not provided with FWD/DND button can be assigned as the FWD/DND button.
- PT** • The lighting patterns of the FWD/DND button are as follows.
 - Off: Both functions are not set.
 - Red: DND mode
 - Flashing red slowly: FWD mode
- PT** • You can check the assignment by pressing the FWD/DND button while on-hook.



- 1.2 Proprietary Telephone Settings, “Customizing the Buttons on Your Telephone”, FWD/DND Button
- 1.7 Useful Features, “Rejecting Incoming Calls (Do Not Disturb — DND)”
- 1.7 Useful Features, “Voice Mail Integration”
- See the Installation Manual, Section 3, “Call Forwarding”.

All Calls

You can re-direct all of your calls to another extension.

Setting

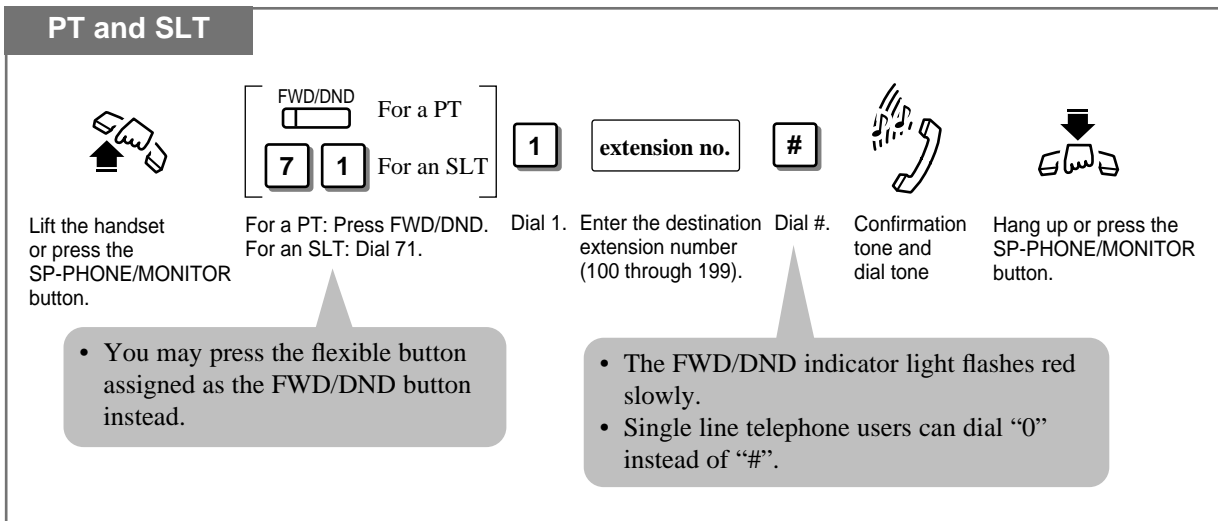

1.6 Before Leaving Your Desk

Busy or No Answer

You can forward your calls to another extension when your extension is busy or if you do not answer the call within a pre-determined time.

Setting

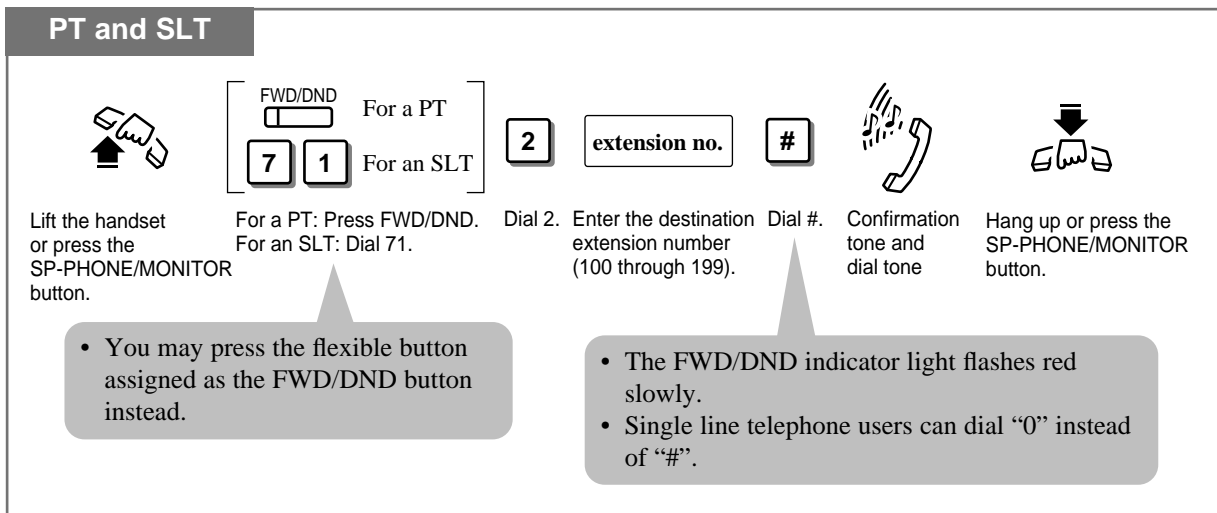

! **PT** • “Voice Call” and “Handsfree Answerback” do not work when Call Forwarding — Busy or No Answer is set.

☞ • 1.2 Proprietary Telephone Settings, “Customizing Your Telephone Functions”, Intercom Alert Assignment

To Outside (CO) Line

You can forward calls to an external party.
System Programming is required to execute this feature.

Setting

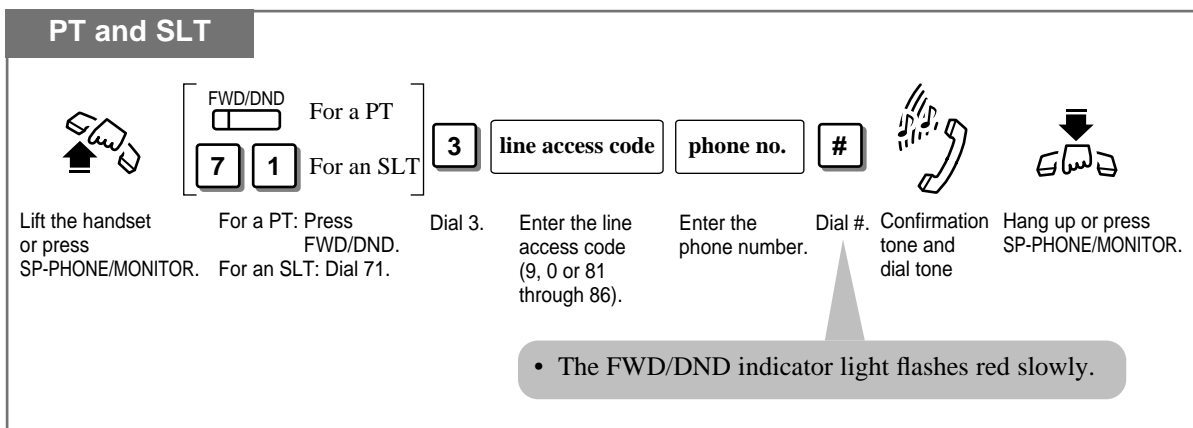

1.6 Before Leaving Your Desk



- If an incoming outside call is forwarded to an outside (CO) line, the “Outside-to-Outside (CO-to-CO) Line Call Duration Time” is applied to the call and the line will be disconnected when it expires (default: 10 min.). An alarm tone is sent to both parties 15 seconds before the assigned duration time limit.
- Up to 32 digits (including the line access code) can be programmed.
- If a CPC or reverse signal is sent to an outside (CO) line before the assigned duration time limit, a call between two external parties will be disconnected.
- This feature cannot be used for incoming outside calls from lines assigned as “Normal”, by System Programming.
- In the account code verify-all, verify-toll and forced modes, an account code must be stored by pressing “* *” and entering the account code after the line access code (“*” is not regarded as a pause).

Follow Me

You can set the “Call Forwarding” feature from the destination extension. This is useful if you forget to set “Call Forwarding — All Calls” before you leave your desk.

Setting

PT and SLT

At the destination extension



Lift the handset or press the SP-PHONE/MONITOR button.

FWD/DND
7 1

For a PT: Press FWD/DND.
For an SLT: Dial 71.

5

Dial 5.

extension no.

Enter your extension number (100 through 199).

#

Dial #.



Confirmation tone and dial tone



Hang up or press the SP-PHONE/MONITOR button.

- You may press the flexible button assigned as the FWD/DND button instead.
- The FWD/DND indicator light flashes red slowly.
- Single line telephone users can dial “0” instead of “#”.



- This feature can be canceled at your extension or the destination extension.

1.6 Before Leaving Your Desk

Cancel

There are two canceling methods for “Call Forwarding”. The canceling depends on the Call Forwarding type that has been assigned.

Canceling Call Forwarding at your (original) extension

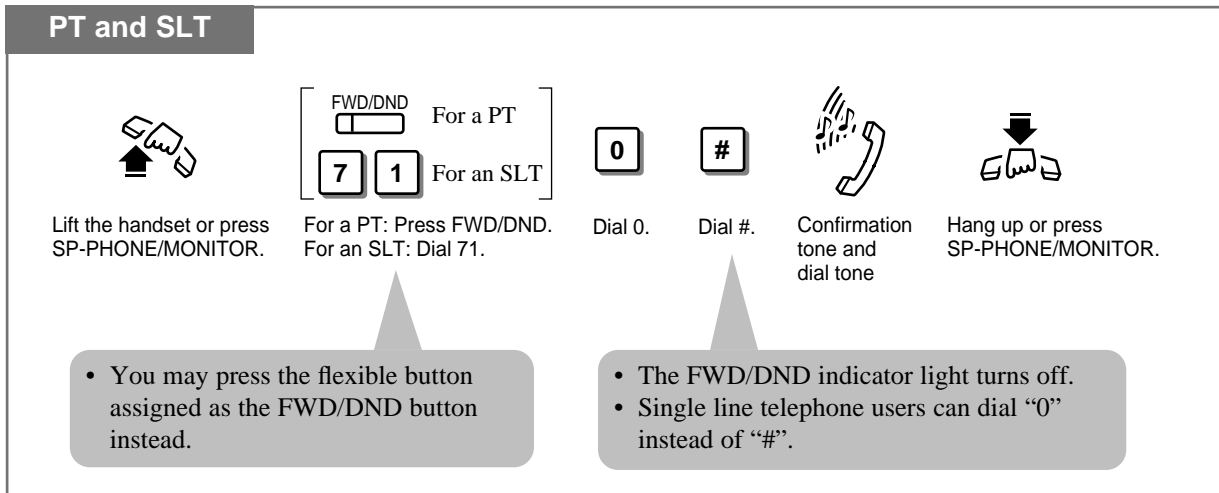

Canceling Call Forwarding at the destination extension — “Follow Me (All Calls)” only

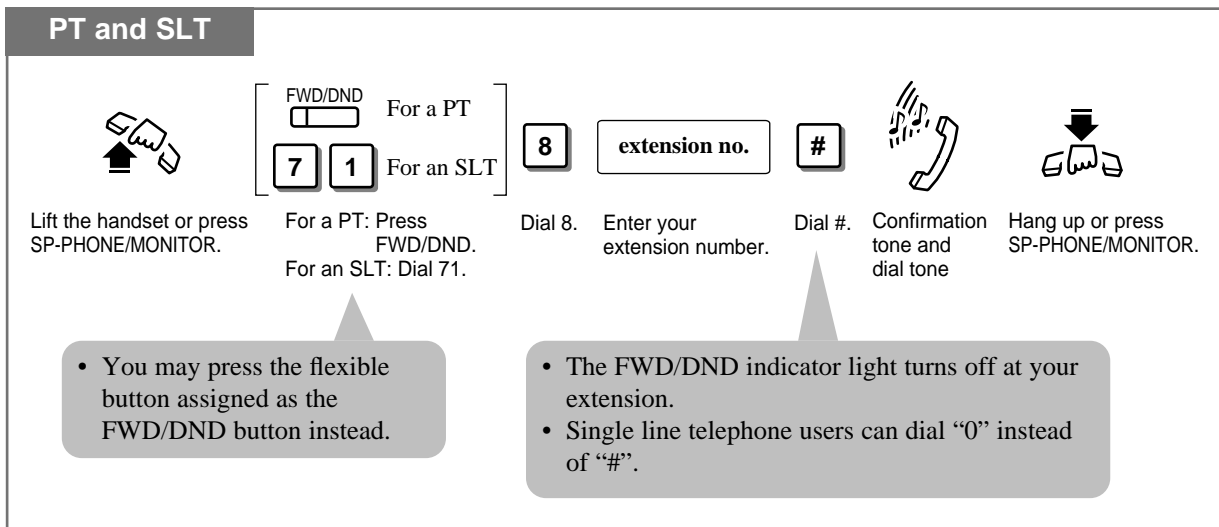

1.6 Before Leaving Your Desk

Locking Your Telephone (Electronic Station Lockout)

Allows you to lock your extension so that other users cannot make outside calls from your extension.

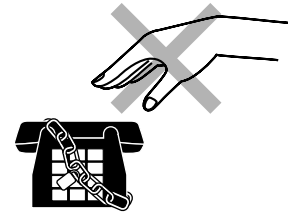

Locking

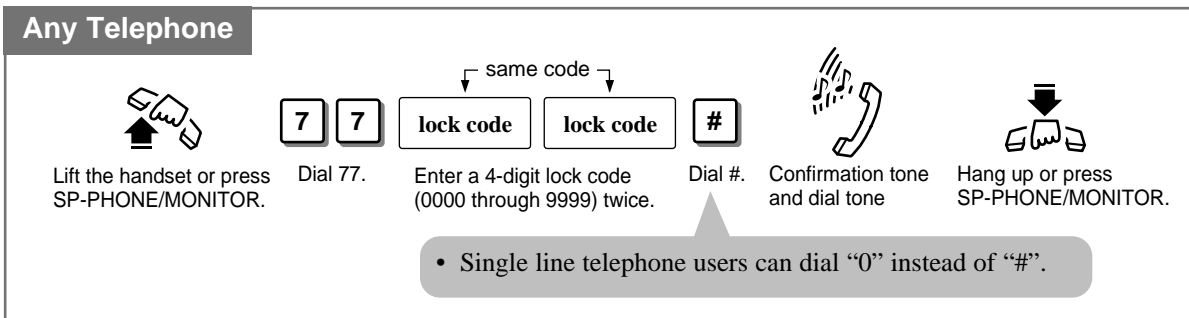

Unlocking

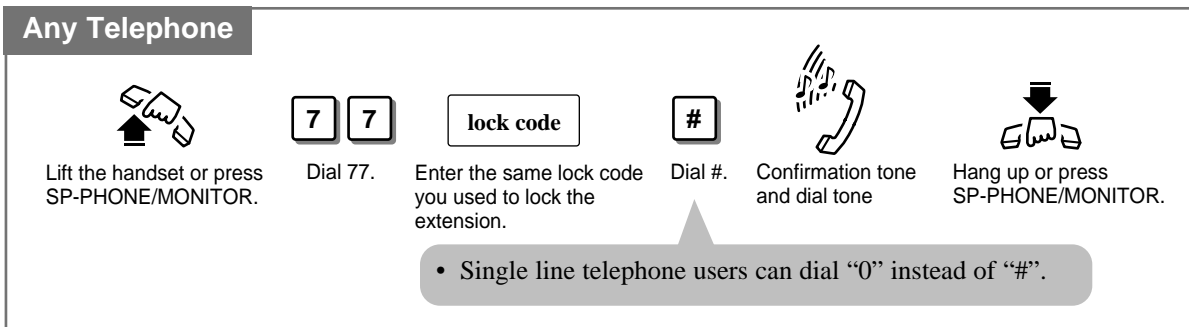

- If another user tries to access an outside (CO) line from a locked extension, the user will hear a reorder tone and for PT users “Restricted” is shown on the display. However, calls can be made at a locked extension depending on system programming. System programming determines which COS number applies to calls at the locked extension.
- An extension assigned as an operator or manager can cancel this function for all extensions (Electronic Station Lockout — CANCEL ALL).
- “Remote Station Lock Control” overrides this feature. If the operator or manager sets Remote Station Lock on the extension you have already locked, you cannot unlock it.
- The lock code must be 4 digits except for the “#” and “*” buttons.
- You can make intercom calls and receive intercom or outside calls at a locked extension.
- You can make outside calls depending on the toll restriction class.



- 1.8 Operator/Manager Service Features, “Electronic Station Lockout — CANCEL ALL”
- 1.8 Operator/Manager Service Features, “Remote Station Lock”
- See the Installation Manual, Section 3, “Toll Restriction — Station Lock Boundary Class”.
- See the Installation Manual, Section 3, “Station Lock”.

1.6 Before Leaving Your Desk

Showing Your Message on the Calling Party's Display (Absent Message Capability)

When a caller using a proprietary telephone with a LCD dials another extension, a programmed Absent Message (Message 1 through 6) will be displayed on the calling party's LCD. Absent Messages can be programmed at any telephone (SLT or PT).

Setting the absent message

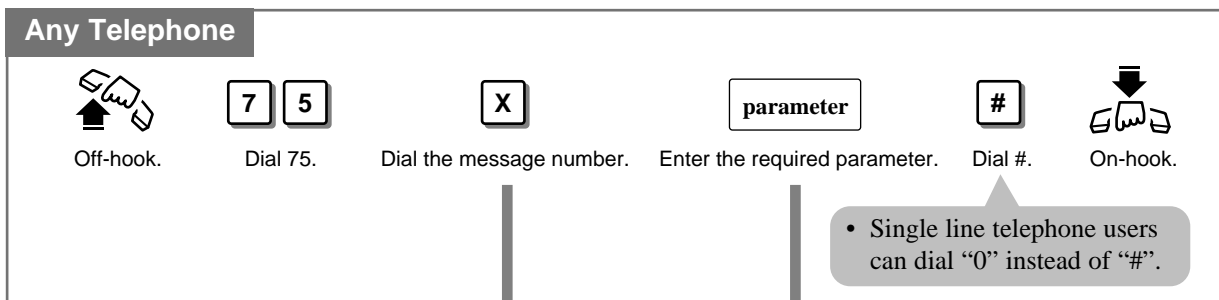

DISPLAY MESSAGE	MESSAGE NO.	PARAMETER
Will Return Soon	<input type="text" value="1"/>	
Gone Home	<input type="text" value="2"/>	
At Ext %%% (extension number)	<input type="text" value="3"/>	<input type="text" value="extension no."/> Enter the extension number (100 though 199).
Back at %:%: AM (or PM) (hour:minute)	<input type="text" value="4"/>	<input type="text" value="hour"/> <input type="text" value="minute"/> <input type="text" value="0"/> or <input type="text" value="1"/> Enter the hour (01 through 12). Enter the minute (00 through 59). For AM: press 0. For PM: press 1.
Out Until %%/%% (month/day)	<input type="text" value="5"/>	<input type="text" value="month"/> <input type="text" value="day"/> Enter the month (01 through 12). Enter the day (01 through 31).
In a Meeting	<input type="text" value="6"/>	
Cancel	<input type="text" value="0"/>	

Note: % indicates where you enter the desired parameter.



• To confirm the message, go off-hook. It will be displayed.



• See the Installation Manual, Section 3, "Absent Message Capability".

1.7 Useful Features

Conference (3-party)

During a 2-party conversation, you can add a third party to make a 3-party conference. The maximum number of extensions and outside (CO) lines in a conference can be changed by System Programming.

Establishing a conference

PT

During a 2-party conversation

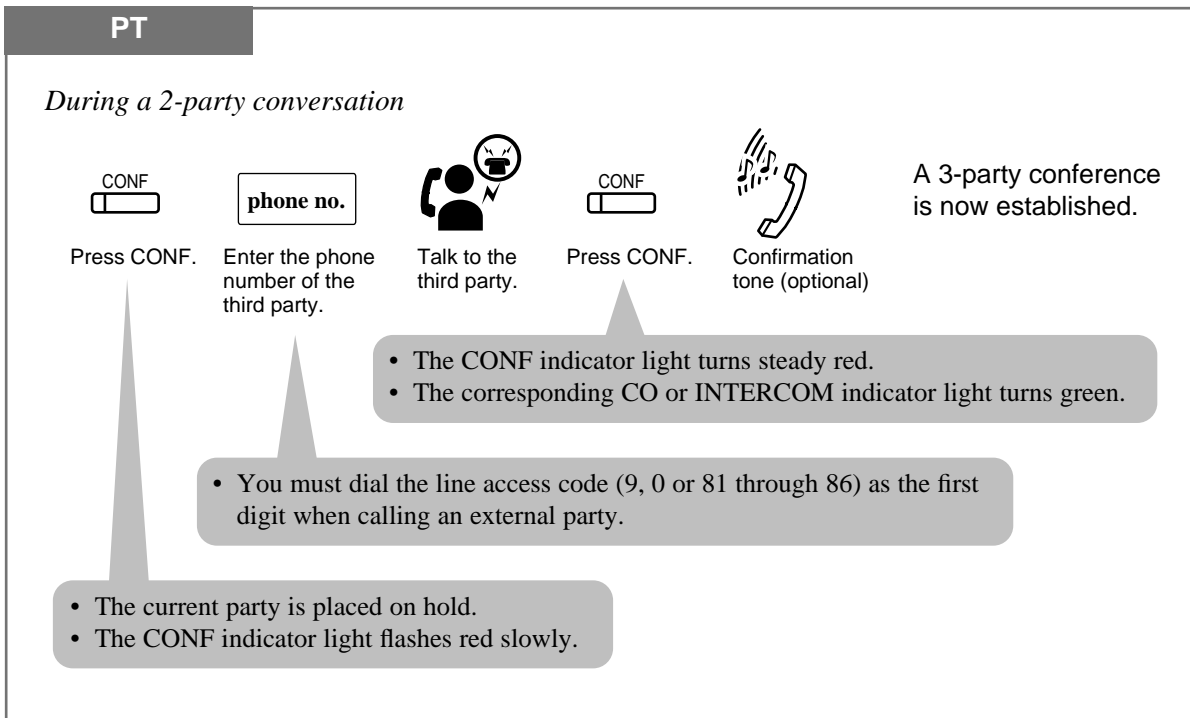

CONF

phone no.

CONF

CONF

A 3-party conference is now established.

Press CONF. Enter the phone number of the third party. Talk to the third party. Press CONF. Confirmation tone (optional)

- The current party is placed on hold.
• The CONF indicator light flashes red slowly.
- The CONF indicator light turns steady red.
• The corresponding CO or INTERCOM indicator light turns green.
- You must dial the line access code (9, 0 or 81 through 86) as the first digit when calling an external party.

SLT

During a 2-party conversation

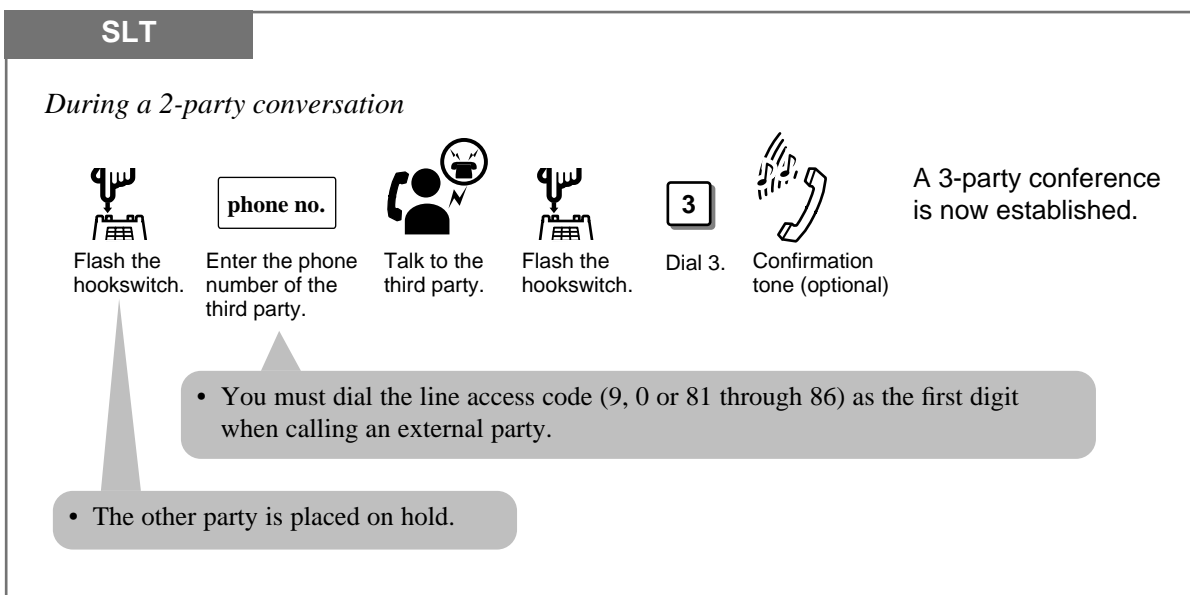

Flash the hookswitch. Enter the phone number of the third party. Talk to the third party. Flash the hookswitch. Dial 3. Confirmation tone (optional)

A 3-party conference is now established.

- The other party is placed on hold.
- You must dial the line access code (9, 0 or 81 through 86) as the first digit when calling an external party.

1.7 Useful Features

To leave the conference

Any telephone



Hang up or press SP-PHONE.

- The other two parties may continue their conversation.
- If the other two parties are both outside (CO) lines, they will be disconnected.

To talk to the original party while holding the third party

SLT



Flash the hookswitch.



Confirmation tone (optional)



Talk to the original party.

To terminate one party and talk to the other

PT

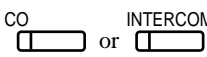

Press the CO or INTERCOM of the party to remain connected.



Confirmation tone (optional)



Talk.

- A conversation with the desired party is established and the other party is disconnected.



- A conference call can also be established by “Executive Busy Override”.
- When a 2-party call is changed to a 3-party call or vice versa, a confirmation tone is sent to all parties. The tone can be disabled.
- PT** • Pressing a CO button which is not in the conference allows you to exit from the conference, leaving the other two parties connected unless they are both outside (CO) lines. If the other parties are both outside (CO) lines, they will be disconnected.
- PT** • If the third party does not answer, press the CO button or INTERCOM button to return to the second party.
- PT** • To change a 3-party conference to a 5-party conference, refer to “Conference (5-party)”.
- SLT** • You can return to the original party before the third party answers by flashing the hookswitch.
- SLT** • If “Hold-2” or “Hold-3” is assigned in System Programming, you must dial “20” after flashing the hookswitch.

1.7 Useful Features



- 1.2 Proprietary Telephone Settings, “Customizing the Buttons on Your Telephone”, CONF (Conference) Button
- 1.3 Making Calls, “Interrupting an Existing Call (Executive Busy Override)”, Executive Busy Override — Extension
- 1.3 Making Calls, “Interrupting an Existing Call (Executive Busy Override)”, Executive Busy Override — Outside (CO) Line”
- 1.7 Useful Features, “Conference, Unattended”
- See the Installation Manual, Section 3, “Conference (3-party)”.

Conference, Unattended

When you are in a conference with two outside parties, you can leave the conference call allowing the other two parties to continue their conversation.

To establish an Unattended Conference

PT

During a conversation with two outside parties

CONF

Press CONF to leave the conference.

• An outside-to-outside (CO-to-CO) line call between the other two parties is established.

To return to the conference

PT

CO

Press the CO flashing green moderately.



- PT** • System programming is required to execute this feature.
- PT** • During a 5-party conference, you cannot use this feature.
- PT** • When an Unattended Conference is established, an alarm tone is sent to both outside parties 15 seconds before the assigned time limit (default: 10 min.). “Hold Recall” is activated at the extension that leaves the conference 50 seconds before the time out. The call is disconnected when the time out expires unless the extension returns to the conference.
- PT** • For example, if you are on-hook and hear “Hold Recall” during the Unattended Conference mode, the display will show “CO 2 & CO 3” for 50 seconds before the time out.



- 1.7 Useful Features, “Conference (3-party)”
- See the Installation Manual, Section 3, “Conference (3-party)”.

1.7 Useful Features

Conference (5-party)

Allows you to establish a 5-party conference. The members of a conference may be up to 5 extensions, or 3 extensions and 2 outside (CO) lines.

Establishing a conference

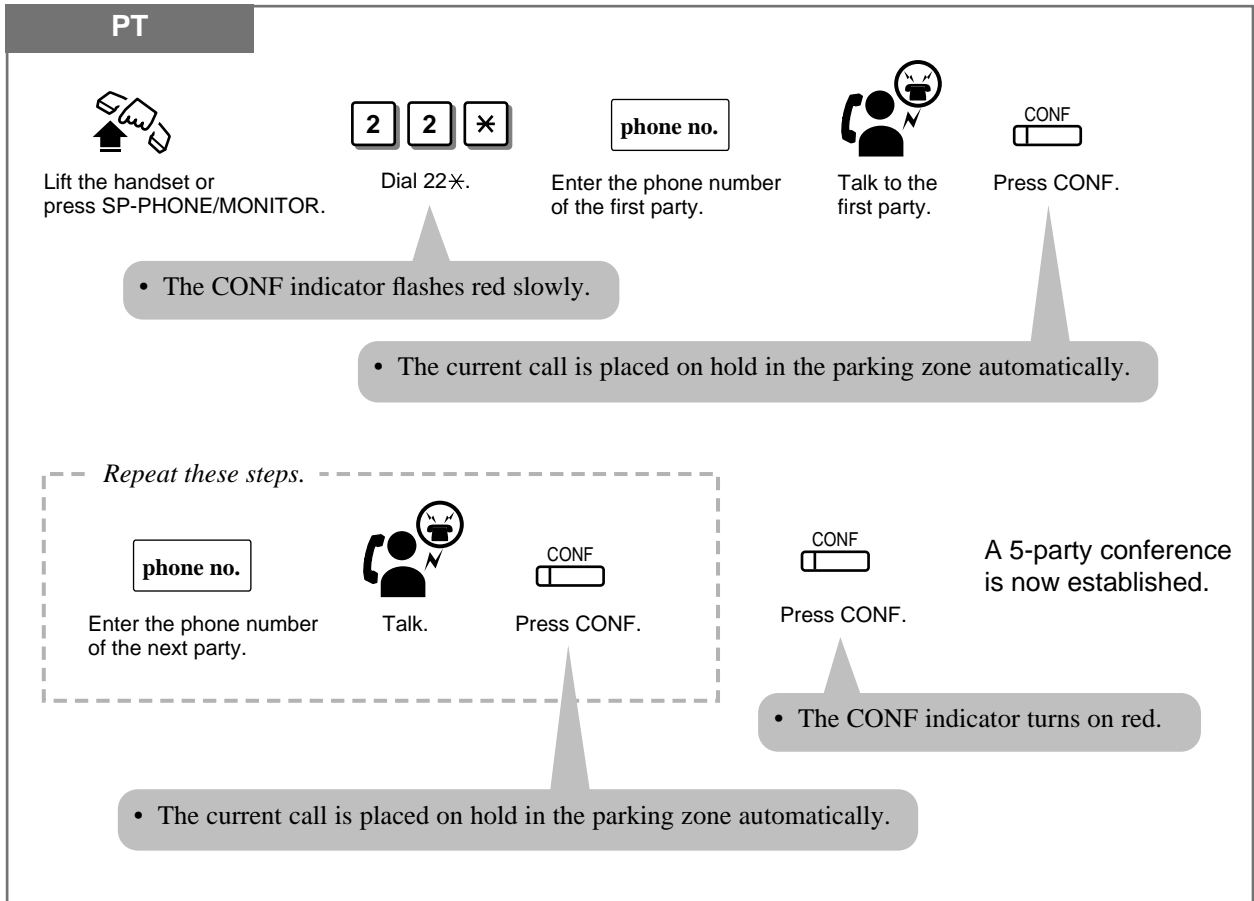

1.7 Useful Features

To change to a 5-party conference during a 3-party conference

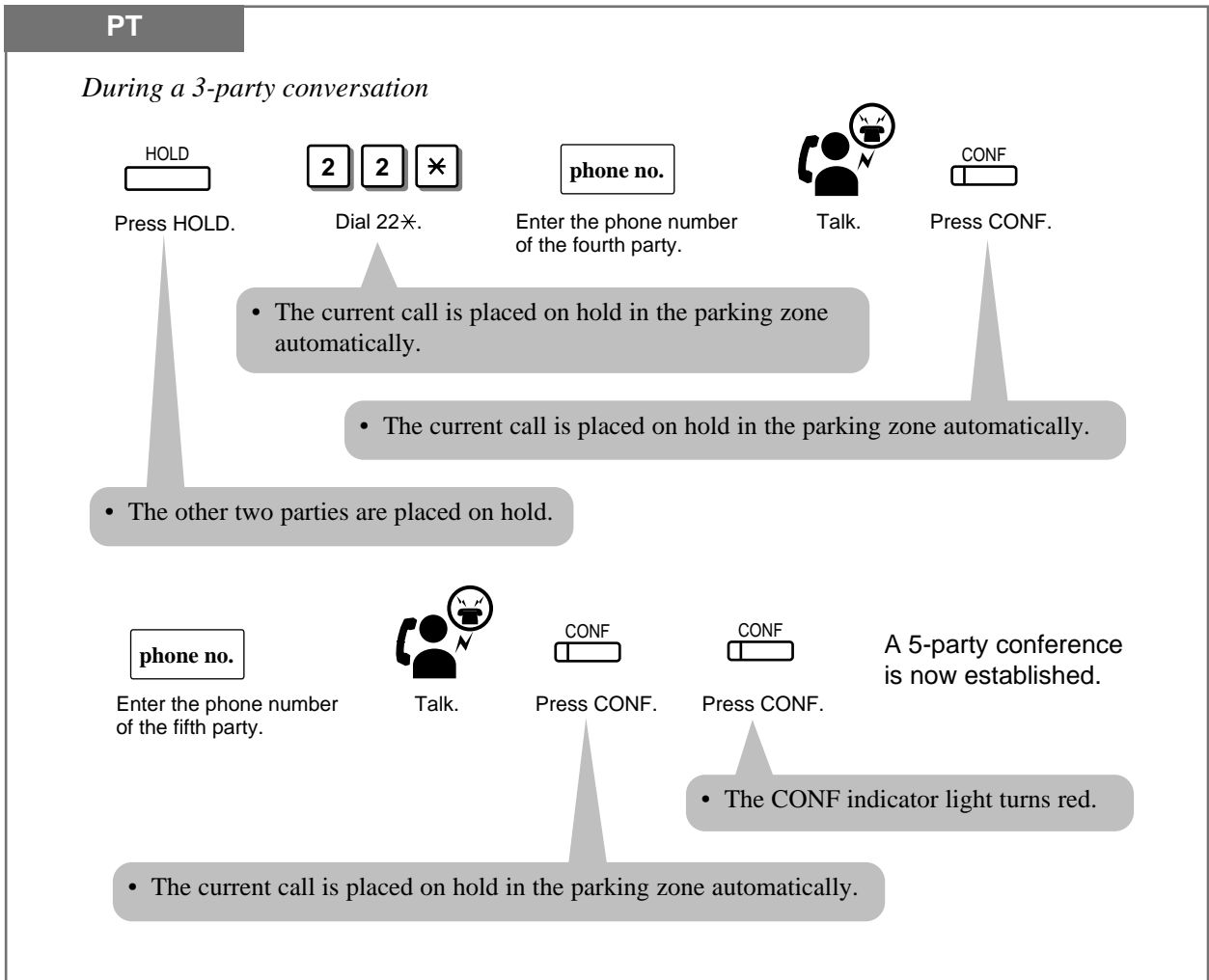

1.7 *Useful Features*



- PT • System programming is required to execute this feature.
- PT • Up to 2 outside (CO) lines can join a conference.
- PT • When a 5-party conference is changed to a 4-party conference, a confirmation tone is sent to all parties. The tone can be disabled.
- PT • A 3-party conference between 3 extensions cannot be changed to a 5-party conference. (The HOLD button cannot be used.)
- PT • When a 5-party conference is established, a confirmation tone is sent to all parties. The tone can be disabled.
- PT • More than one 5-party conference cannot be established at the same time.
- PT • The Unattended Conference and Executive Busy Override features are not available during a 5-party conference.
- PT • During a 5-party conference, the Call Park feature cannot be used by another extension.
- PT • If parked calls are not retrieved within 5 minutes during a 5-party conference, ringing or an alarm tone will be heard (Call Park Recall).
- PT • When the extension who started the 5-party conference goes on-hook, the 5-party conference is terminated.
- PT • When an incoming call is received, a Call Waiting tone is heard. You can answer the call after leaving the conference by going off-hook.
- SLT • This feature cannot be used with a single line telephone.



- 1.3 Making Calls, “Interrupting an Existing Call (Executive Busy Override)”
- 1.5 During a Conversation, “Call Waiting”
- 1.7 Useful Features, “Conference (3-party)”
- 1.7 Useful Features, “Conference, Unattended”
- See the Installation Manual, Section 3, “Conference (5-party)”.

1.7 Useful Features

Leaving a Message Notification (Message Waiting)

When the called extension is busy or does not answer your call, you can leave a notification so that the called party may call you back.

As a message receiver, the MESSAGE button light lets you know that a call has been received. If you receive notification, you can call back the original party by a simple operation. This feature is available only for proprietary telephones with MESSAGE buttons.

Leaving a message notification

Any Telephone

Lift the handset or press SP-PHONE/MONITOR. Dial 701. Enter the extension number (100 through 199) where the calls will be left. Dial #. Confirmation tone and dial tone Hang up or press SP-PHONE/MONITOR.

- Single line telephone users can dial “0” instead of “#”.

PT

If the called extension is busy or does not answer

Press MESSAGE. Confirmation tone and dial tone Hang up or press SP-PHONE/MONITOR.

Canceling a message notification

Any Telephone

Lift the handset or press SP-PHONE/MONITOR. Dial 702. Enter the extension number (100 through 199) where you left a message. Dial #. Confirmation tone and dial tone Hang up or press SP-PHONE/MONITOR.

- Single line telephone users can dial “0” instead of “#”.

Canceling using the MESSAGE button

PT

Lift the handset or press SP-PHONE/MONITOR. Enter the extension number (100 through 199) where you left a message. Press MESSAGE twice. Confirmation tone and dial tone Hang up or press SP-PHONE/MONITOR.

1.7 Useful Features

Checking and Selecting a message notification by the message receiver

If there is a message, the message waiting lamp (MESSAGE indicator) light will be on.

PT

When the telephone is idle and on-hook

MESSAGE 

Press MESSAGE repeatedly until the desired message appears.

- The stored messages are shown on the display in the order they were received.

Calling back the message notification sender

PT

 Lift the handset or press SP-PHONE/MONITOR.

MESSAGE  Press MESSAGE.

 Talk.

- If you have more than one message at your extension, the line connects you to the selected message sender.
- The message is cleared after the conversation.

Clearing all message notifications by the message receiver

PT

 Lift the handset or press SP-PHONE/MONITOR.

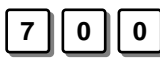
 Dial 700.

 Dial #.

 Hang up or press SP-PHONE/MONITOR.

- All messages are cleared.



- PT** • Each extension can have a maximum of 8 simultaneous messages. If you try to set the ninth message, you will hear a reorder tone.
- PT** • If the MESSAGE indicator does not go out after calling the extension which left the message, another message is waiting.
- PT** • If multiple message notifications are left at your extension, call back is executed in the order received.
- PT** • If you select a specific message to call back, the other call backs will be executed in the order received, starting with the one selected.
(e.g.) 5 → 6 → 7 → 8 → 1 → 2 → 3 → 4



- 1.2 Proprietary Telephone Settings, “Customizing the Buttons on Your Telephone”, Restoring the MESSAGE Button
- See the Installation Manual, Section 3, “Message Waiting”.

1.7 Useful Features

Calling with Account Codes (Account Code Entry)

An account code is used to identify outside calls for accounting and billing purposes. The account code is appended to the “Station Message Detail Recording (SMDR)” call record. For incoming outside calls, account codes are not required. For outgoing outside calls, account codes are often required. You can enter account codes in the following 4 modes.

Verify - All mode: You must always enter the pre-assigned account code.

Verify - Toll mode: You must always enter the pre-assigned account code. You can enter your extension password so that you can override toll restriction.

Option mode: An account code can be entered when a record of the account code is required. It can be any number.

Forced mode: You must always enter an account code. It can be any number.

Making calls with account codes except in the Option mode

PT and SLT

Lift the handset or press SP-PHONE/MONITOR.

Press CO or enter a line access code (9, 0 or 81 through 86).

For a PT: Press FWD/DND or PAUSE.
For an SLT: Dial 49 or *.*

Enter an account code (4 digits).

Dial tone

Enter the phone number.

Making calls with account codes in the Option mode and receiving calls

PT

During a conversation or while hearing a reorder tone after the other party hangs up (within 30 seconds)

Press FWD/DND.

Enter an account code (4 digits).

• You can keep talking.

1.7 *Useful Features*



- In the Verify-All and Verify-Toll modes, you must always enter a pre-assigned account code.
- You do not need to make an account code entry when receiving incoming calls.
- You can clear and re-enter a number by pressing “* *” or the FWD/DND button while entering an account code.
- An account code can be stored into Memory Dialing (“One-Touch Dialing”, “Pickup Dialing”, “System/Personal Speed Dialing”, “Call Forwarding — to Outside (CO) Line”). The sequence to enter an account code into Memory Dialing is as follows.
— **[Feature Number] [Line Access Code] [* *] [Account Code] [Phone Number]**
- If an entered account code does not match the pre-assigned account code in the verify-all mode or the verify-toll mode, when making an outside call, a reorder tone is heard.

PT

- An account code has 4 digits (0 through 9). FLASH, PAUSE, etc. cannot be used.



- 1.8 Operator/Manager Service Features, “Extension Password Set (Manager only)”
- See the Installation Manual, Section 3, “Station Message Detail Recording (SMDR)”.
- See the Installation Manual, Section 3, “Account Code Entry”.
- See the Installation Manual, Section 3, “Toll Restriction Override by Extension Password”.

1.7 Useful Features

Rejecting Incoming Calls (Do Not Disturb — DND)

Allows you to prevent other parties from disturbing you. Your extension will not receive intercom or outside calls.

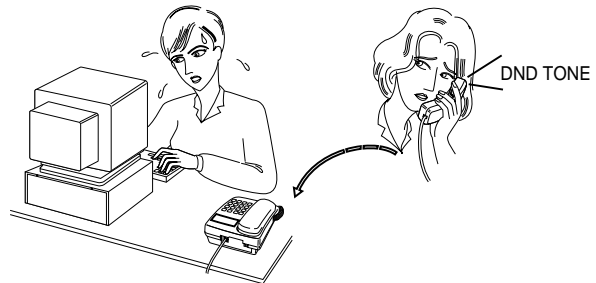



Setting / Canceling

PT and SLT

 Lift the handset or press SP-PHONE/MONITOR.

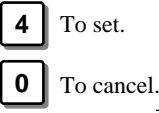
 For a PT: Press FWD/DND. For an SLT: Dial 71.

 To set: Dial 4. To cancel: Dial 0.

 Dial #.

 Confirmation tone and dial tone

 Hang up or press SP-PHONE/MONITOR.

• Single line telephone users can dial “0” instead of “#”.



- A calling extension that has “Do Not Disturb (DND) Override” enabled can override your extension when the “Do Not Disturb (DND)” mode is set.
- DND also inhibits for paging.
- If the Call Forwarding feature has already been set, setting the DND feature will cancel Call Forwarding.
- The Timed Reminder alarm and Hold Recall features override this feature.
- PT** • A flexible CO button on a proprietary telephone which is not provided with FWD/DND button can be assigned as the FWD/DND button.
- PT** • If the “Do Not Disturb (DND)” mode is set, you can still answer a call by pressing the CO button.
- PT** • The lighting patterns of the FWD/DND button are as follows.
 - Off: Both functions are not set.
 - Red: DND mode
 - Flashing red slowly: FWD mode



- 1.2 Proprietary Telephone Settings, “Customizing the Buttons on Your Telephone”, FWD/DND Button
- 1.6 Before Leaving Your Desk, “Forwarding a Call (Call Forwarding)”
- 1.7 Useful Features, “Calling an Extension which Denies Receiving Calls (Do Not Disturb Override)”
- See the Installation Manual, Section 3, “Do Not Disturb (DND)”.

1.7 Useful Features

Calling an Extension which Denies Receiving Calls (Do Not Disturb Override)

Allows you to call an extension even though the “Do Not Disturb — DND” feature is set. System Programming is required to use this feature.

Any Telephone

If you make an intercom call and hear a Do Not Disturb (DND) tone



DND tone



Dial 2.



Wait for an answer.



- If you hear a reorder tone after dialing 2, the “Do Not Disturb Override” feature is not set at your extension.
- If you hear a busy tone after dialing 2, the line is busy. You can use the Automatic Callback Busy feature.



- 1.7 Useful Features, “Rejecting Incoming Calls (Do Not disturb — DND)”
- See the Installation Manual, Section 3, “Do Not Disturb (DND)”.

1.7 Useful Features

Secret Dialing

Allows you to conceal all or part(s) of a “System Speed Dialing number” or “One-Touch Dialing number” assigned to a flexible button, both which normally appear on the display.

PT

When storing the phone number

INTERCOM



Press INTERCOM before and after the part you wish to conceal.

<PT Display Example>

9-1-[201] . . . — “201” is not shown on the display when you dial.

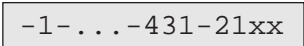

- PT** • A secret code, “[” or “]” (pressing the INTERCOM button), are counted as 1 digit.
- PT** • You can conceal one or more parts of a telephone number.
- PT** • If the phone number “9-1-[201]-431-21xx” has been stored, the display will show the following when the call is made.

- PT** • You can program whether to print out the concealed number(s) on the SMDR or not by System Programming.
- PT** • Do not press the INTERCOM button before a line access number (9, 0 or 81 through 86).



- 1.2 Proprietary Telephone Settings, “Customizing the Buttons on Your Telephone”, One-Touch Dialing Button
- 1.3 Making Calls, “Dialing by Simply Pressing a Button (One-Touch Dialing)”
- 1.3 Making Calls, “Dialing with a System Speed Dialing Button (System Speed Dialing)”
- See the Installation Manual, Section 3, “Secret Dialing”.

1.7 Useful Features

Alarm Setting (Timed Reminder)

You can receive a ringback at your telephone to remind you of a meeting or appointment. Either one time or daily (everyday until canceled) is available at a pre-set time. At home, you can also use this feature as a wake-up call.



Setting

Any Telephone

 Lift the handset or press SP-PHONE/MONITOR.

7 **6** Dial 76.

hour Enter the hour (01 through 12).

minute Enter the minute (00 through 59).

0 or **1** For AM: Dial 0. For PM: Dial 1.

1 or **2** For a one time alarm*¹: Dial 1. For a daily alarm*²: Dial 2.

Dial #.

 Hang up or press SP-PHONE/MONITOR.

- Single line telephone users can dial “0” instead of “#”.

*¹ An alarm will be heard at the preset time and then the setting is cleared.
*² An alarm will be heard daily at the preset time until the setting is changed or canceled.

Canceling

Any Telephone

 Lift the handset or press SP-PHONE/MONITOR.

7 **6** **2** **#** Dial 762#.

 Confirmation tone and dial tone

 Hang up or press SP-PHONE/MONITOR.

- Single line telephone users can dial “0” instead of “#”.

1.7 Useful Features

Checking the set time (with a display PT only)

PT



Lift the handset or press SP-PHONE/MONITOR.



Dial 763#.



Hang up or press SP-PHONE/MONITOR.

Stopping the alarm

Any Telephone



Lift the handset.

- Pressing any key also stops the alarm.



- Be sure the system clock is set correctly.
- The alarm continues for 30 seconds.
- If you receive an incoming call during the alarm, ringing starts after the alarm stops.
- If the alarm is set to sound during a conversation, the alarm will start after the conversation.
- If you set a new time, the preset time will be cleared.



- See the Installation Manual, Section 3, “Timed Reminder”.

1.7 Useful Features

Time (Day/Night/Lunch) Service

This system supports the Day, Night and Lunch modes. The system operation for originating and receiving calls can be different in the day, night and lunch modes. “Time Service” can only be set by the operator and manager. For a PT user, even if your extension is not assigned as the operator or manager, you can use your display to check the current mode.

Confirming the current mode (with a display PT only)

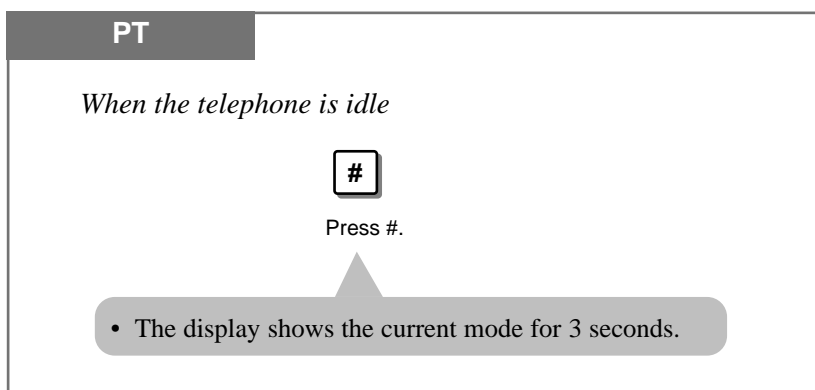

- The Day/Night/Lunch mode is automatically switched at a predetermined time (default: 9:00 a.m. for every day, 5:00 p.m. for every night), if the automatic mode is selected.



- 1.8 Operator/Manager Service Features, “Time(Day/Night/Lunch) Service Setting”
- See the Installation Manual, Section 3, “Time (Day/Night/Lunch) Service”.

1.7 Useful Features

Joining or Leaving a Call Distribution Group (Log-In/Log-Out)

Allows you to assign the Log-In mode or Log-Out mode within a hunting, DISA ring or UCD group. When in the Log-Out mode, you can leave the group temporarily, preventing hunting calls from being sent to your extension. The lighting patterns of the Log-In/Log-Out button on a proprietary telephone and status are as follows.

Off: Log-In mode
Red: Log-Out mode

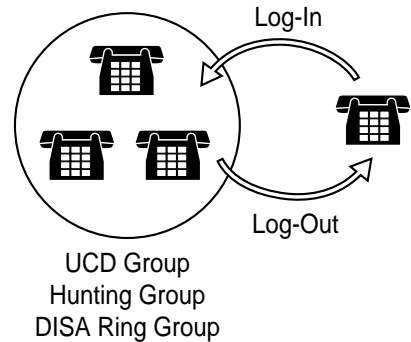

Log-In / Log-Out (Using the Log-In/Log-Out button)

PT

Lift the handset or press SP-PHONE/MONITOR.

Press the flexible button assigned as the Log-In/Log-Out button.

Confirmation tone and dial tone

Hang up or press SP-PHONE/MONITOR.

- The indicator light turns off in Log-In mode or turns steady red in Log-Out mode.

Log-In / Log-Out (Using the feature number)

Any Telephone

Lift the handset or press SP-PHONE/MONITOR.

[7 3 6 0 # To Log-In.
7 3 6 1 # To Log-Out.]

For Log-In mode: Dial 7360#.
For Log-Out mode: Dial 7361#.

Confirmation tone and dial tone

Hang up or press SP-PHONE/MONITOR.

- Single line telephone users can dial "0" instead of "#".



- The default is "Log-In" mode.
 - There should be at least one extension in the group that is in the Log-In mode.
 - When in the Log-Out mode, the last extension in a UCD group cannot leave the group.
- PT**
- The Log-In/Log-Out button can be assigned to a flexible CO button.



- 1.2 Proprietary Telephone Settings, "Customizing the Buttons on Your Telephone", Log-In/Log-Out Button
- See the Installation Manual, Section 3, "Station Hunting".
- See the Installation Manual, Section 3, "Direct Inward System Access (DISA)".
- See the Installation Manual, Section 3, "Uniform Call Distribution (UCD)".
- See the Installation Manual, Section 3, "Log-In/Log-Out".

1.7 Useful Features

Room Monitor

Allows you to monitor a room through a proprietary telephone with an AUTO ANSWER/MUTE button (AUTO ANS/MUTE button on a KX-T7300 series). The proprietary telephone you want to monitor should be prepared for monitoring beforehand. You can also monitor through a doorphone. You can use a proprietary telephone with an AUTO ANSWER/MUTE button (AUTO ANS/MUTE button on a KX-T7300 series) and single line telephone with a MUTE button for monitoring.

Setting a monitor by PT

PT

At the monitored telephone

Lift the handset or press SP-PHONE/MONITOR.

Dial 7351#.

Confirmation tone

Hang up or press SP-PHONE/MONITOR.

Press AUTO ANSWER/MUTE.

- The AUTO ANSWER/MUTE indicator is flashing moderately.

Monitoring

PT and SLT

SP-PHONE AUTO ANSWER/MUTE For a PT

MUTE

MUTE

MUTE For an SLT

extension no.

Room monitoring starts.

For a PT: Press SP-PHONE and AUTO ANSWER/MUTE.
For an SLT: Lift the handset and press the MUTE button.

Enter the monitored extension number (100 through 199).

Paging a monitored room

PT

AUTO ANSWER/MUTE or

MUTE

Press AUTO ANSWER/MUTE or lift the handset.

Talk.

Canceling a monitor temporarily

PT

At the monitored telephone

AUTO ANSWER/MUTE

MUTE

Press AUTO ANSWER/MUTE.

- The AUTO ANSWER/MUTE indicator turns off.

Canceling

PT

Lift the handset or press SP-PHONE/MONITOR.

Dial 7350#.



Confirmation tone

Hang up or press SP-PHONE/MONITOR.

1.7 Useful Features

Monitoring through a doorphone

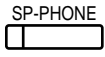
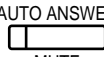
PT and SLT

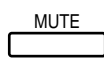
 SP-PHONE	 AUTO ANSWER MUTE	For a PT		<div style="border: 1px solid black; padding: 2px; display: inline-block;">3</div> <div style="border: 1px solid black; padding: 2px; display: inline-block; margin-left: 10px;">1</div>	<div style="border: 1px solid black; padding: 2px; display: inline-block;">doorphone no.</div>		Monitoring starts.
 ↑	 MUTE	For an SLT					

For a PT: Press SP-PHONE and AUTO ANSWER/MUTE. Dial 31. Enter the monitored doorphone number (1 through 4).
 For an SLT: Lift the handset and press the MUTE button.



- PT • The doorphone access tone can be eliminated by System Programming.
- PT • System Programming is required to monitor through a PT.
- PT • The access tone will not be sent to the monitored PT. The paging tone will also not be sent to the monitored PT.
- PT • This feature is not available for the KX-T7350, KX-T7050 and KX-T7055.





- See the Installation Manual, Section 3, “Room Monitor”.
- See the Installation Manual, Section 3, “Doorphone Call”.

Data Line Security

Your extension can be protected against interruptions from the “Call Waiting”, “Hold Alarm”, and “Executive Busy Override” features. Data communication devices, such as computers and facsimiles, can operate uninterrupted.

Setting / Canceling

Any Telephone

 ↑	<table style="border: 1px solid black; padding: 5px; margin: auto;"> <tr> <td style="border: 1px solid black; padding: 2px;">7</td> <td style="border: 1px solid black; padding: 2px;">3</td> <td style="border: 1px solid black; padding: 2px;">0</td> <td style="border: 1px solid black; padding: 2px;">1</td> <td style="border: 1px solid black; padding: 2px;">#</td> <td style="padding-left: 5px;">To set.</td> </tr> <tr> <td style="border: 1px solid black; padding: 2px;">7</td> <td style="border: 1px solid black; padding: 2px;">3</td> <td style="border: 1px solid black; padding: 2px;">0</td> <td style="border: 1px solid black; padding: 2px;">0</td> <td style="border: 1px solid black; padding: 2px;">#</td> <td style="padding-left: 5px;">To cancel.</td> </tr> </table>	7	3	0	1	#	To set.	7	3	0	0	#	To cancel.		 ↓
7	3	0	1	#	To set.										
7	3	0	0	#	To cancel.										
Lift the handset or press SP-PHONE/MONITOR.	To set: Dial 7301#. To cancel: Dial 7300#.	Confirmation tone and dial tone	Hang up or press SP-PHONE/MONITOR.												

• Single line telephone users can dial “0” instead of “#”.



- 1.3 Making Calls, “Interrupting an Existing Call (Executive Busy Override)”, Executive Busy Override — Extension
- 1.3 Making Calls, “Interrupting an Existing Call (Executive Busy Override)”, Executive Busy Override — Outside (CO) Line
- 1.5 During a Conversation “Call Waiting”
- See the Installation Manual, Section 3, “Data Line Security”.
- See the Installation Manual, Section 3, “Hold”.

1.7 Useful Features

Parallel Connection of a Proprietary Telephone and Single Line Telephone (Paralleled Telephone Connection)

Any extension connected to extension jacks 01 through 16 can be connected in parallel with a proprietary telephone and a single line telephone. In the event of a power failure, CO1 and CO4 can be accessed using the single line telephones that are connected in parallel with the proprietary telephones to extension jacks 01 and 09 respectively. If the extension receives a call, ringing will be heard from the proprietary telephone and the single line telephone. You can answer the call by using either the proprietary telephone or the single line telephone. An answering machine, facsimile, MODEM (personal computer), etc., can be connected instead of a single line telephone.

System Programming is required to enable this feature.



- PT** • A proprietary telephone LCD will show you a single line telephone is in use.
- SLT** • The following features will not work with a single line telephone connected in parallel with a proprietary telephone.
 - Call Splitting
 - External Feature Access
 - Account code input
 - Conference
 - Pickup dialing
- SLT** • A single line telephone connected in parallel with a proprietary telephone cannot make a call in the following cases.
 - The proprietary telephone is set to the BGM mode.
 - The proprietary telephone is receiving a page through the built-in speaker.
 - The proprietary telephone is set to the PROGRAM mode.
- SLT** • A single line telephone connected in parallel with a proprietary telephone will not ring in the following cases.
 - The proprietary telephone is set to Handsfree Answerback.
 - The proprietary telephone is set to “Voice Call” in the Intercom Alert Assignment.



- See the Installation Manual, Section 3, “Paralleled Telephone Connection”.

Mixed Station Dialing

Any telephone, either a KX-T7033/KX-T7030/KX-T7020/KX-T7050/KX-T7055/KX-T7330/KX-T7320/KX-T7350/KX-T7130, single line rotary phone (10 pps, 20 pps) or single line touch tone telephone, may be used as an extension for the system.

1.7 Useful Features



External Feature Access

Allows you to access special features (e.g. Call Waiting) offered by a host PBX or Central Office. This feature is effective only during an outside call. You can access the feature by using either the FLASH button or the feature number.

Using the FLASH button

PT

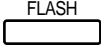
During a conversation with an outside party



Press FLASH. Enter the desired service code.

• The current call is placed on hold.

Using the feature number

SLT

During a conversation with an outside party

Flash the hookswitch. Dial 6. Enter the desired service code.

• The current call is placed on hold.



- PT** • A “Flash Time” must be assigned as required by the host PBX, or outside (CO) line.
- PT** • You may access some features of the host PBX using the FLASH button. If the system is connected to a host PBX and the flash operation is required, follow the flash operation procedure which is required by the host PBX.
- FLASH button also allows you to disconnect the current call and make another call without hanging up by System Programming. You can also assign a flexible button for the flash button.



- 1.2 Proprietary Telephone Settings, “Customizing the Buttons on Your Telephone”, One-Touch Access for System Features
- 1.3 Making Calls, “Flash”
- See the Installation Manual, Section 3, “External Feature Access”.

1.7 Useful Features

Self-Extension Number Confirmation (KX-T7330/KX-T7030/KX-T7130/KX-T7033 only)

Allows you to display your jack and extension number.

To program, set the MEMORY switch on the proprietary telephone to “PROGRAM” or press the PROGRAM button on the KX-T7300 series.

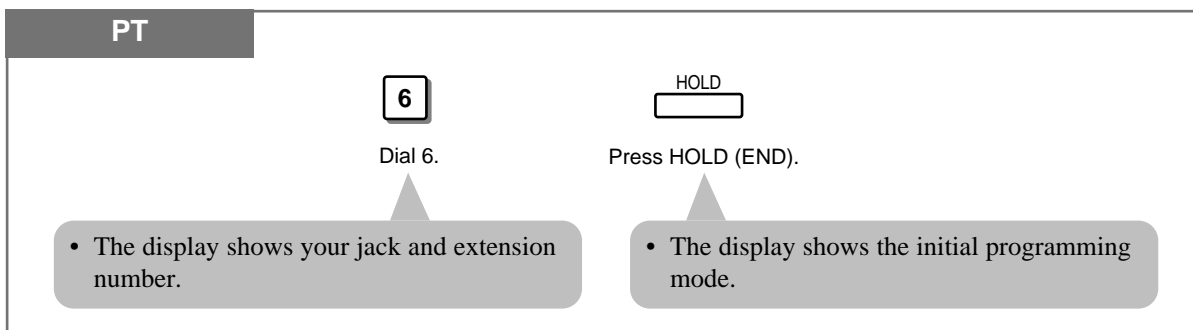

- Be sure the handset is on the cradle and the SP-PHONE button is off.
- After programming, return the MEMORY switch to the “SET” position or press the PROGRAM button on the KX-T7300 series.
- You can confirm your Self-Extension Number by pressing “* *” while on-hook.



- See the Installation Manual, Section 3, “Self-Extension Number Confirmation (KX-T7330/KX-T7030/KX-T7130/KX-T7033 only)”.

Turning on the Background Music (BGM)

You can listen to background music through the built-in speaker of the telephone. An external music source, such as a radio, must be connected. The music stops whenever a call comes in or when you go off-hook.

Setting / Canceling

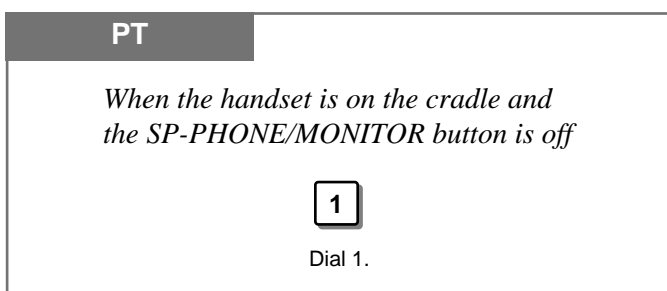

- See the Installation Manual, Section 3, “Music on Hold/Background Music (BGM)”.

1.7 Useful Features

Extension Button Confirmation (KX-T7330/KX-T7030/KX-T7130/KX-T7033 only)

You can confirm the values stored in the button using the LCD.

Checking

Press the button you want to confirm.

PT						
REDIAL <input type="text"/>	SAVE <input type="text"/>	<input type="text"/>	FWD/DND <input type="text"/>	MESSAGE <input type="text"/>	CO <input type="text"/>	No. <input type="text"/>
Press REDIAL.	Press SAVE.	Press PROGRAMMABLE FEATURE.	Press FWD/DND.	Press MESSAGE.	Press CO.	Press DSS.

DSS Console	
No. <input type="text"/>	<input type="text"/>
Press DSS.	Press PROGRAMMABLE FEATURE.



- Be sure the handset is on the cradle and the SP-PHONE button is off.
- When the display exceeds 17 characters, the “&” mark will be displayed on the right side of the LCD.



- See the Installation Manual, Section 3, “Extension Button Confirmation (KX-T7330/KX-T7030/KX-T7130/KX-T7033 only)”.

Pulse to Tone Conversion

Allows you to change the dialing mode from Pulse to Tone to access services, such as computer telephone services and Voice Mail which require tones.

Any Telephone		
<input type="text"/> phone no. (Pulse mode)	<input type="text"/> * <input type="text"/> #	<input type="text"/> desired no. (Tone mode)
Enter the phone number (Pulse mode).	Dial *#.	Enter the desired number (Tone mode).



- You cannot change from Tone to Pulse dialing mode.



- See the Installation Manual, Section 3, “Pulse to Tone Conversion”.

1.7 Useful Features

Canceling the Feature Settings (Station Feature Clear)

Allows you to reset the following station features to the default settings.

- a) Absent Message Capability
- b) Automatic Callback Busy (Camp-On)
- c) Background Music (BGM)
- d) Call Forwarding
- e) Call Pickup Deny
- f) Call Waiting
- g) Data Line Security
- h) Do Not Disturb (DND)
- i) Executive Busy Override Deny
- j) Log-In/Log-Out
- k) Message Waiting – (All messages will be erased.)
- l) Pickup Dialing – (The stored telephone number will be erased.)
- m) Paging-Deny
- n) Room Monitor
- o) Timed Reminder
- p) Voice Mail Integration

Clearing the current feature settings

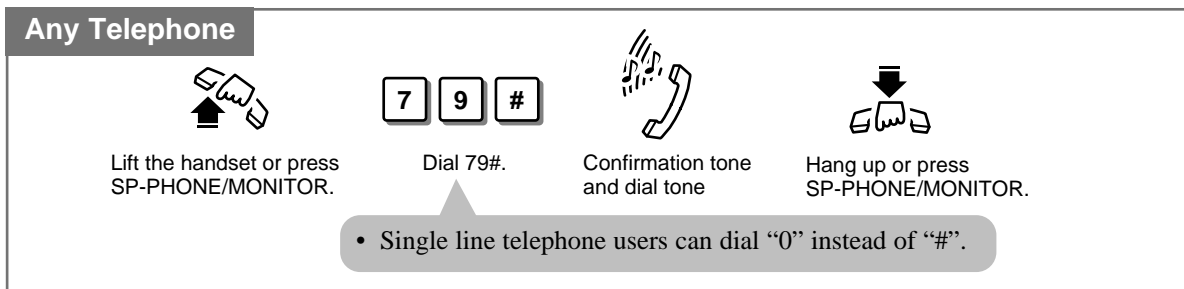

- See the Installation Manual, Section 3, “Station Feature Clear”.

Alternate Calling — Ring/Voice (Voice to Ring only)

“Voice Call” (through the built-in speaker) which is set at the called party’s extension can be switched to “Tone Call” (ringing). This feature must be set beforehand at the called party’s extension. Refer to Proprietary Telephone Settings (Section 1.2). A rotary phone cannot be used.

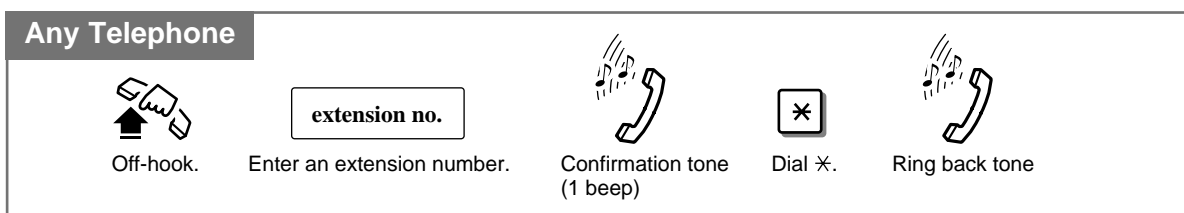

- See the Installation Manual, Section 3, “Alternate Calling — Ring/Voice (Voice to Ring only)”.

1.7 Useful Features

Doorphone Call

Allows you to have a conversation with a visitor at your doorphone.
Up to 4 doorphones can be connected to the system.

Calling an extension from a doorphone

Any Doorphone

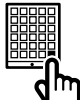

Press the Doorphone button for 1 second.



Wait for an answer and talk.

Answering a doorphone call

Any Telephone

When you hear the doorphone ring tone at the extension:



Lift the handset or press SP-PHONE/MONITOR.

Calling a doorphone

Any Telephone



Lift the handset or press SP-PHONE/MONITOR.



Dial 31.



Enter a doorphone number (1 through 4).



Confirmation tone



Talk.



- An optional doorphone/door opener card and doorphones are necessary for this feature.
- If you do not answer an incoming doorphone call within 15 or 30 seconds, the call will be canceled.
- You must program the extensions which can receive calls from each doorphone for the day, night and lunch modes.
- Any extension user can call a doorphone.
- The Call Waiting feature is not available with doorphone calls.
- Doorphone 1 and Doorphone 2 cannot receive calls simultaneously. When one is in use, an extension user cannot have a conversation with the other. This is the same for Doorphone 3 and Doorphone 4.
- Doorphones can also be used for the Room Monitor feature.



- 1.7 Useful Features, “Room Monitor”
- See the Installation Manual, Section 3, “Doorphone Call”.

1.7 Useful Features

Door Opener

Allows you to unlock the door from your telephone.
Up to 4 door openers can be connected to the system.

To unlock the door from an assigned extension

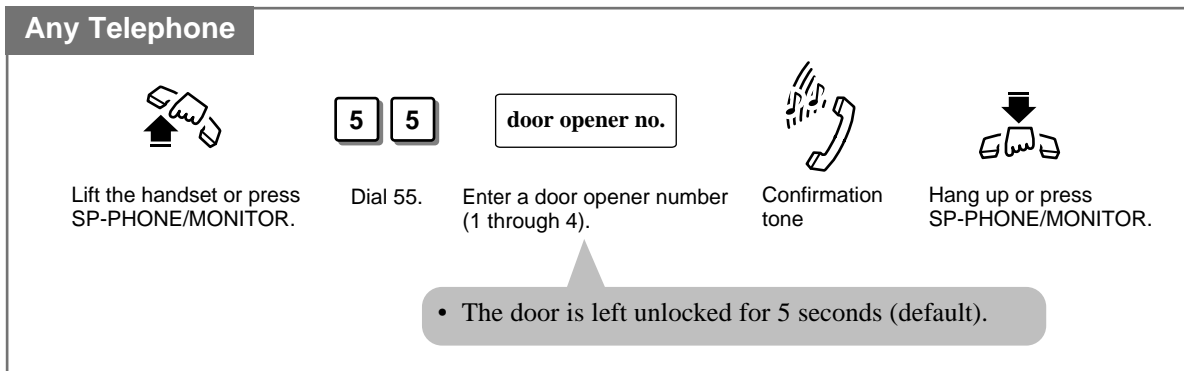

To unlock the door while talking to the doorphone

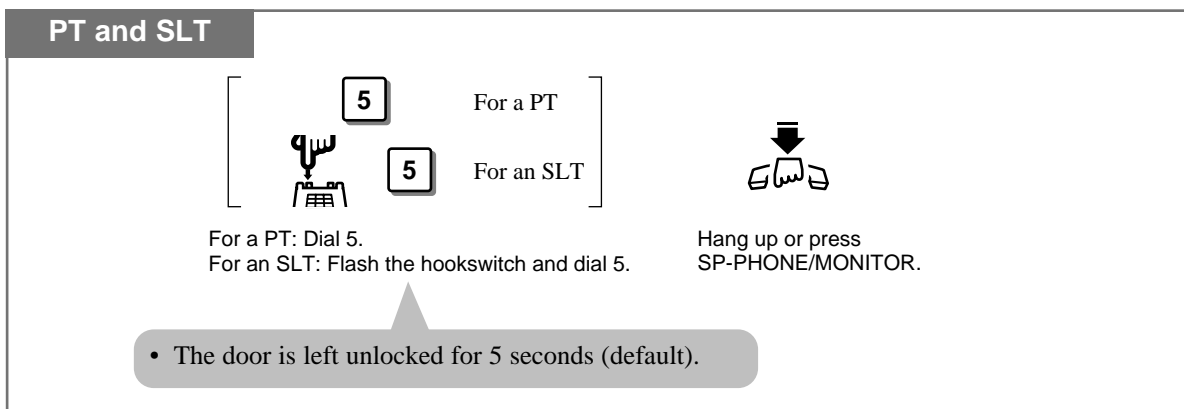

- An optional doorphone/door opener card is necessary for this feature.
- If you dial 5 again while the door is open, the door will stay open for another 5 seconds (default).
- You can program the extensions which can open the doors for the day, night and lunch modes.
- You can modify the door opener timer in System Programming.
- The door opener will open the door, even if a doorphone is not installed.



- See the Installation Manual, Section 3, "Door Opener".

1.7 Useful Features

Voice Mail Integration

Allows you to use a Voice Processing System to forward your calls to a mailbox in the system. A caller can leave a message in your mailbox. If you use a proprietary telephone which has a MESSAGE button, the button light will turn on to let you know you have messages. If you use a single line telephone, dial tone 3 will let you know you have messages when you go off-hook.

If this feature is enabled, the system automatically sends the Follow-on ID to the Voice Mail Port before connecting the caller. You must choose one of the following two settings for the Follow-on ID format.

Setting A: only sends the extension number to the Voice Mail Port.

Setting B: sends “#6” followed by the extension number. “#6” is used by a Panasonic KX-Voice Processing System to force the VPS port into voice mail service.

The setting depends on the format required by your voice processing system.

Setting

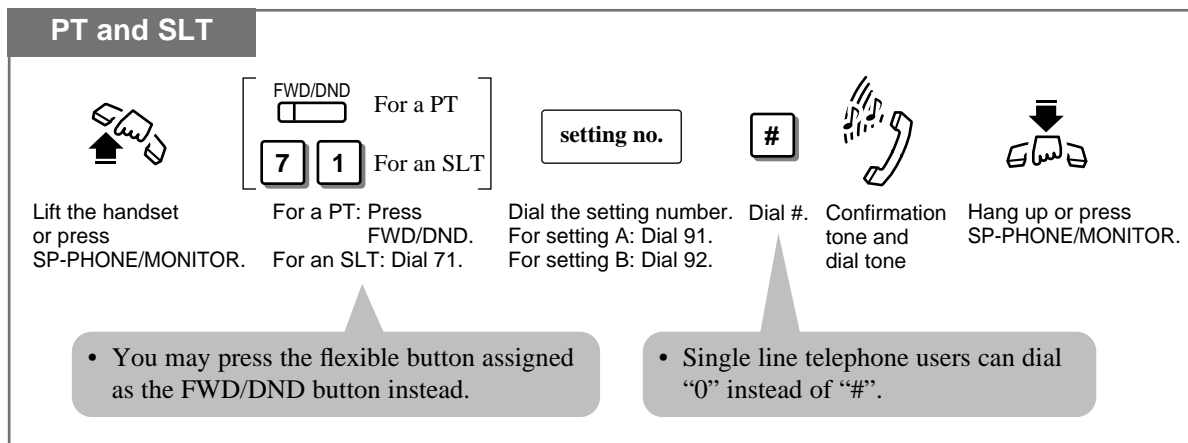

Listening to a stored message

You can listen to the messages stored in your mailbox easily. There are two operations to play back messages.

Using the Message Waiting (MESSAGE) button

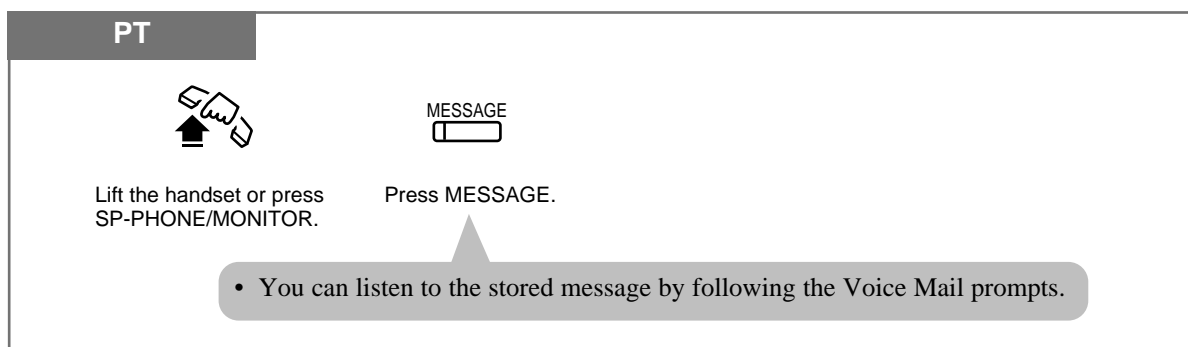

1.7 Useful Features

By manual dialing

Any Telephone



Lift the handset or press
SP-PHONE/MONITOR.

Voice Mail extension no.

Enter the Voice Mail extension number.

- When you use an SLT, you will hear dial tone 3 if there are messages.

- You can listen to the stored message by following the Voice Mail prompts.

Canceling

PT and SLT



Lift the handset or press
SP-PHONE/MONITOR.

FWD/DND

For a PT

7 1

For an SLT

For a PT: Press FWD/DND.
For an SLT: Dial 71.

9 0 #

Dial 90#.



Confirmation tone
and dial tone



Hang up or press
SP-PHONE/MONITOR.

- Single line telephone users can dial “0” instead of “#”.

- You may press the flexible button assigned as the FWD/DND button instead.



- To forward your calls to your mailbox by the Call Forwarding feature, you have to set “Call Forwarding — All Calls” or “Call Forwarding — Busy or No Answer”. The setting is as follows.
[Off-hook] [FWD/DND or 71] [91# or 92#] (after hearing a confirmation tone and dial tone) [FWD/DND or 71] [1 (All Calls) or 2 (Busy or No Answer)] [Voice mail extension number] [#] [On-hook]
- The canceling is as follows.
[Off-hook] [FWD/DND or 71] [90#] (after hearing a confirmation tone and dial tone) [FWD/DND or 71] [0#] [On-hook]

PT

- A flexible button can be assigned as the FWD/DND button.

SLT

- You will hear dial tone 3 if there are messages in your mailbox when you go off-hook. When you access voice mail, you have to listen to all of the new messages. If you do not listen to all of the messages, dial tone 3 will be eliminated and you will not know there are messages in your mailbox the next time you go off-hook.



- 1.2 Proprietary Telephone Settings, “Customizing the Buttons on Your Telephone”, FWD/DND Button, Restoring the Message Button
- 1.6 Before Leaving Your Desk “Forwarding a Call (Call Forwarding)”, All Calls, Busy or No Answer
- See the Installation Manual, Section 3, “Intercept Routing”.
- See the Installation Manual, Section 3, “Voice Mail Integration”.

1.7 Useful Features

Calling Using Your Privileges at Another Extension (Walking COS)

Allows you to use your calling privileges (TRS — Class of Service) at another extension. You may override restrictions which may be set at the extension.

Making a call

Any Telephone

At another extension

The diagram illustrates the steps for making a call using Walking COS. It shows a sequence of actions: lifting the handset, dialing 7*, entering an extension password, entering an extension number, dialing #, receiving a confirmation tone, and entering the phone number. A call icon is shown above the # and phone number steps. A callout box provides an additional instruction: "You must dial a line access code (9, 0 or 81 through 86) or press the CO button when calling an external party."

	7 *	extension password	extension no.	#		phone no.
Lift the handset or press SP-PHONE/MONITOR.	Dial 7*.	Dial your extension password.	Enter your extension number (100 through 199).	Dial #.	Confirmation tone and dial tone	Enter the phone number.

• You must dial a line access code (9, 0 or 81 through 86) or press the CO button when calling an external party.



- TRS Class of Service (COS) is used to define the feature. Each extension is assigned a TRS COS number.
- If your extension is assigned to the Account Code — Forced or Verify – All mode, you must enter the account code before the line access code.
- A rotary telephone cannot use this feature.

SLT



- 1.8 Operator/Manager Service Features, “Extension Password Set (Manager only)”
- See the Installation Manual, Section 3, “Toll Restriction Override by Extension Password”.
- See the Installation Manual, Section 3, “Walking COS”.

1.7 Useful Features

Ring Pattern Selection

A different ringing pattern is used to distinguish intercom calls from incoming outside calls.

- You can select the ringing pattern as follows in System Programming.
 - Outside (CO) line: 3 patterns (A, B or C)
 - Extension: 3 patterns (A, B or C)
 - Doorphone: 4 patterns (A, B, C or D)

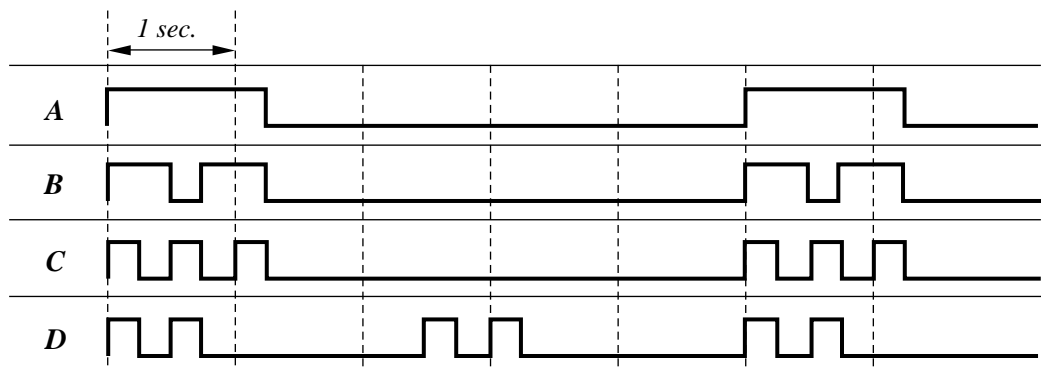

- 2.1 Tone / Ring Tone List
- See the Installation Manual, Section 3, “Ring Pattern Selection”.

Distinctive Dial Tone

A distinctive dial tone will be heard from the handset if the extension user has previously activated a certain feature.

Dial Tone 1: Ordinary dial tone

Dial Tone 2: When any of the following features are activated.

- Absent Message Capability
- Back Ground Music (BGM) (only a proprietary telephone)
- Call Forwarding
- Call Pickup Deny
- Data Line Security
- Do Not Disturb (DND)
- Electronic Station Lockout
- Message Waiting (only a proprietary telephone)
- Pickup Dialing (only a single line telephone)
- Timed Reminder

Dial Tone 3: When performing Account Code Entry and answering a Timed Reminder call. Also sounds when going off-hook with an SLT which has a message in a Voice Processing System.



- 2.1 Tone / Ring Tone List
- See the Installation Manual, Section 3, “Distinctive Dial Tone”.

1.7 Useful Features

Power Failure Transfer

During a power failure, each outside (CO) line will be connected to an assigned extension.

Outside (CO) line 1: extension jack 01

Outside (CO) line 4: extension jack 09



- During a power failure, all features cannot be used except for incoming and outgoing outside calls from extension jacks 01 and 09.
- If extension jacks 01 and 09 are connected to proprietary telephones, disconnect the units and connect single line telephones.
- Automobile type batteries, which are customer supplied, are available as a system back up power supply to operate all the features during a power failure.
- The batteries can be connected directly to the unit. For more information, refer to the Installation Manual.



- See the Installation Manual, Section 3, “Power Failure Transfer”.

Lockout

If one party in a conversation goes on-hook, both parties will be disconnected from the speech path automatically. A reorder tone is sent to the off-hook party before it is disconnected. No operation is necessary.

1.8 Operator / Manager Service Features

The system supports one operator and one manager. Any extension can be appointed as the operator and extension jack 01 is appointed as the manager. System Programming is required to assign the operator. They can perform the following features.

- 1) Date and Time Setting
- 2) Electronic Station Lockout — CANCEL ALL
- 3) Timed Reminder, Remote (Wake-Up Call)
- 4) Outgoing Message (OGM)
- 5) Remote Station Lock
- 6) Time (Day/Night/Lunch) Service Setting
- 7) Extension Password Set (Manager only)

Date and Time Setting

When the current time setting is wrong, you can adjust it by the following procedure.

Setting

PT

<div style="border: 1px solid black; padding: 2px; display: inline-block; width: 20px; height: 20px; text-align: center; line-height: 20px;">0</div> Dial 0.	<div style="border: 1px solid black; padding: 2px; display: inline-block; width: 60px; height: 20px; text-align: center;">year</div> Enter the year (last 2 digits).	<div style="border: 1px solid black; padding: 2px; display: inline-block; width: 60px; height: 20px; text-align: center;">month</div> Enter the month (01 through 12).	<div style="border: 1px solid black; padding: 2px; display: inline-block; width: 60px; height: 20px; text-align: center;">day</div> Enter the day (01 through 31).	<div style="border: 1px solid black; padding: 2px; display: inline-block; width: 100px; height: 20px; text-align: center;">day of the week</div> Enter the day of the week. 0: For Sun 1: For Mon 2: For Tue 3: For Wed 4: For Thu 5: For Fri 6: For Sat
<div style="border: 1px solid black; padding: 2px; display: inline-block; width: 60px; height: 20px; text-align: center;">hour</div> Enter the hour (01 through 12).	<div style="border: 1px solid black; padding: 2px; display: inline-block; width: 60px; height: 20px; text-align: center;">minute</div> Enter the minute (00 through 59).	<div style="border: 1px solid black; padding: 2px; display: inline-block; width: 20px; height: 20px; text-align: center;">0</div> or <div style="border: 1px solid black; padding: 2px; display: inline-block; width: 20px; height: 20px; text-align: center;">1</div> Dial 0 or 1. For AM: Dial 0. For PM: Dial 1.	<div style="border: 1px solid black; padding: 2px; display: inline-block; width: 60px; height: 20px; text-align: center;">AUTO DIAL STORE</div> Press AUTO DIAL/STORE.	<div style="border: 1px solid black; border-radius: 10px; padding: 5px; background-color: #f0f0f0; width: fit-content; margin: 0 auto;"><ul style="list-style-type: none">• The STORE indicator light turns on.</div>



- Be sure the handset is on the cradle and the SP-PHONE button is off.
- To program, set the MEMORY switch on the proprietary telephone to “PROGRAM” or press the PROGRAM button on the KX-T7300 series.
- After programming, return the MEMORY switch to the “SET” position or press the PROGRAM button on the KX-T7300 series.



- See the Installation Manual, Section 3, “Date and Time Setting”.

1.8 Operator / Manager Service Features

Electronic Station Lockout — CANCEL ALL

You can cancel Electronic Station Lockout at all extensions.

Setting

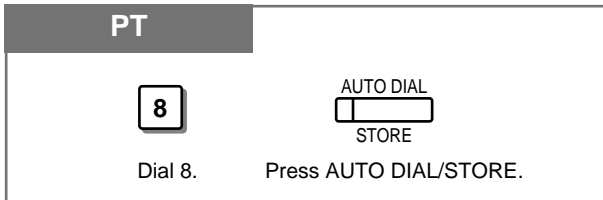

- Be sure the handset is on the cradle and the SP-PHONE button is off.
- To program, set the MEMORY switch on the proprietary telephone to “PROGRAM” or press the PROGRAM button on the KX-T7300 series.
- After programming, return the MEMORY switch to the “SET” position or press the PROGRAM button on the KX-T7300 series.



- See the Installation Manual, Section 3, “Station Lock”.

Timed Reminder, Remote (Wake-Up Call)

The operator or manager can remotely set or cancel the Timed Reminder of a desired extension.

Setting

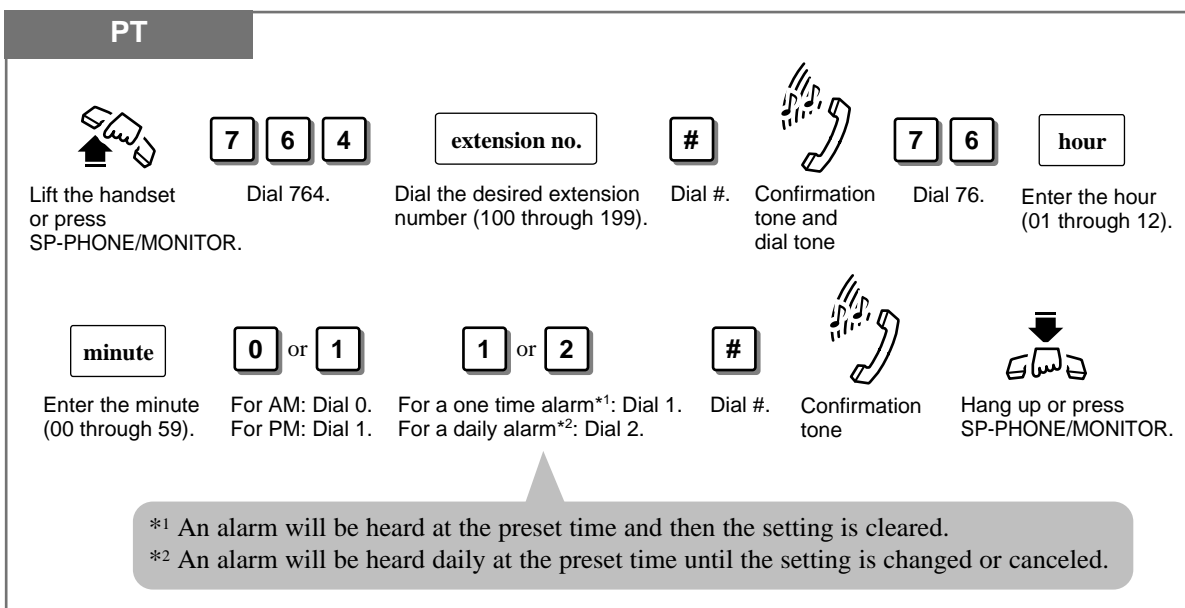

1.8 Operator / Manager Service Features

Canceling

PT

Lift the handset or press SP-PHONE/MONITOR.

Dial 764.

Dial the desired extension number (100 through 199).

Dial #.

Confirmation tone and dial tone

Dial 762#.

Confirmation tone

Hang up or press SP-PHONE/MONITOR.

Checking the time setting (with a display PT only)

PT

Lift the handset or press SP-PHONE/MONITOR.

Dial 764.

Dial the desired extension number (100 through 199).

Dial #.

Confirmation tone and dial tone

Dial 763#.

Confirmation tone

Hang up or press SP-PHONE/MONITOR.



- 1.7 Useful Features, “Alarm Setting (Timed Reminder)”
- See the Installation Manual, Section 3, “Timed Reminder”.

1.8 Operator / Manager Service Features

Outgoing Message (OGM)

The operator or manager can record or play back the outgoing message. This is played when a caller accesses the DISA or UCD feature.

Two Outgoing Messages (OGM 1 and OGM 2) are available for DISA 1, DISA 2, UCD and UCD-END.

To program, set the MEMORY switch on the proprietary telephone to “PROGRAM” or press the PROGRAM button on the KX-T7300 series.

Recording a message

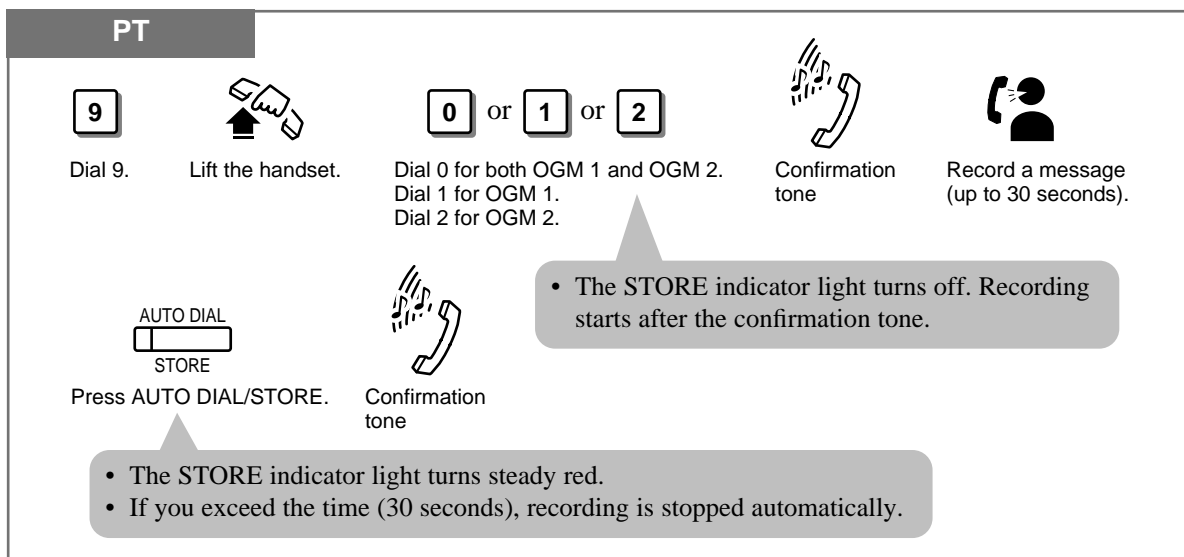

Playing back a message

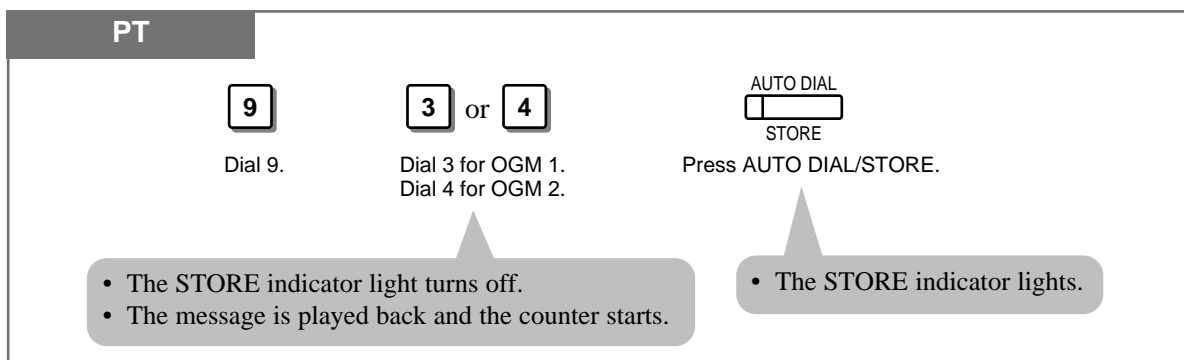

- Be sure the handset is on the cradle and the SP-PHONE button is off.
- After programming, return the MEMORY switch to the “SET” position or press the PROGRAM button on the KX-T7300 series.



- See the Installation Manual, Section 3, “Direct Inward System Access (DISA)”.
- See the Installation Manual, Section 3, “Uniform Call Distribution (UCD)”.
- See the Installation Manual, Section 3, “Outgoing Message (OGM)”.

1.8 Operator / Manager Service Features

Remote Station Lock

The operator or manager can remotely lock or unlock a desired extension. You can lock outside calls.

Locking

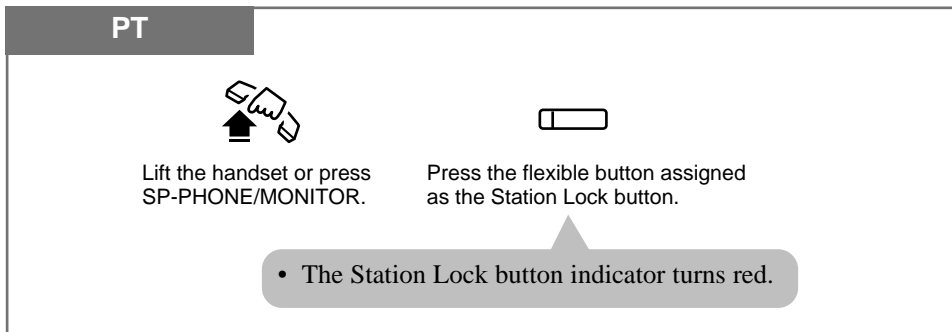

Unlocking

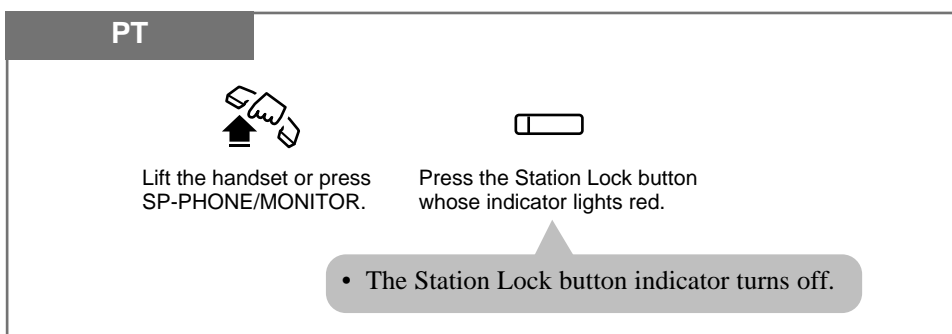

- This feature overrides the “Electronic Station Lockout” feature. If “Electronic Station Lockout” has already been set by the extension user and this feature is set afterwards, the extension user cannot cancel the lock. Only the operator or manager can cancel the lock.
- Extension passwords must be assigned to the operator and manager extensions beforehand.
- An extension user can make a call at the locked extension depending on system programming. System programming determines which COS number applies to a call at the locked extension.



- 1.6 Before Leaving Your Desk, “Locking Your Telephone (Electronic Station Lockout)”
- See the Installation Manual, Section 3, “Station Lock”.

1.8 Operator / Manager Service Features

Time (Day/Night/Lunch) Service Setting



This system supports the day, night and lunch modes. The system operation for originating and receiving calls can be different in the day, night and lunch modes. Toll restriction can be programmed to prevent unauthorized toll calls for each mode.

Changing Day, Night or Lunch mode in manual or automatic mode

PT



Lift the handset or press SP-PHONE/MONITOR.

7	8	1	#	or		For Manual-Day mode
7	8	2	#	or		For Manual-Night mode
7	8	3	#	or		For Manual-Lunch mode

For manual-day mode: Dial 781# or press the DSS button assigned as the Day button.
 For manual-night mode: Dial 782# or press the DSS button assigned as the Night button.
 For manual-lunch mode: Dial 783# or press the DSS button assigned as the Lunch button.



Confirmation tone and dial tone



Hang up or press SP-PHONE/MONITOR.

- The assigned button indicator turns on.

Canceling the manual Day, Night or Lunch mode and returning to the automatic mode

PT



Lift the handset or press SP-PHONE/MONITOR.

7	8	0	#
---	---	---	---

Dial 780#.



Confirmation tone and dial tone



Hang up or press SP-PHONE/MONITOR.

Confirming the current mode (with a display PT only)

PT

When the telephone is idle

#

Press #.

- The display shows the current mode for 3 seconds.

1.8 Operator / Manager Service Features



- The day/night/lunch mode can be changed either automatically at a predetermined time (default: 9:00 a.m. for every day, 5:00 p.m. for every night) or manually at any time by System Programming.
- Even if the automatic mode has been selected by System Programming, the operator or manager can change the day, night and lunch modes manually.
- The following programs have separate day, night and lunch programming.
 - 1) Delayed Ringing Assignment
 - 2) Door Opener Assignment
 - 3) Doorphone Ringing Assignment
 - 4) Flexible Outward Dialing Assignment
 - 5) Flexible Ringing Assignment
 - 6) Outside (CO) Line Mode
 - 7) TRS – Class of Service (COS) Assignment
- If the lunch mode is set using feature number 783# in the automatic mode, the mode will not be changed until the lunch mode is canceled using feature number 780#. The day and night modes are automatically changed at the programmed time even if feature number 780# is not entered.
- Feature number 780# is not accepted in the manual mode.
- One of the day, night or lunch button indicators on the DSS console lights red to display the current mode.
- If the day, night or lunch mode is changed manually in the automatic changing mode and the manager starts System Programming, the manual setting will be canceled after System Programming is completed. It will return to the automatic day, night or lunch mode.



- 1.7 Useful Features, “Doorphone Call”
- 1.7 Useful Features, “Door Opener”
- See the Installation Manual, Section 3, “Direct In Line (DIL)”.
- See the Installation Manual, Section 3, “Toll Restriction”.
- See the Installation Manual, Section 3, “Time (Day/Night/Lunch) Service”.

1.8 Operator / Manager Service Features

Extension Password Set (Manager only)

The manager can assign a password to each extension. The assigned password can be used for the Toll Restriction Override by Extension Password and Walking COS features.

Setting

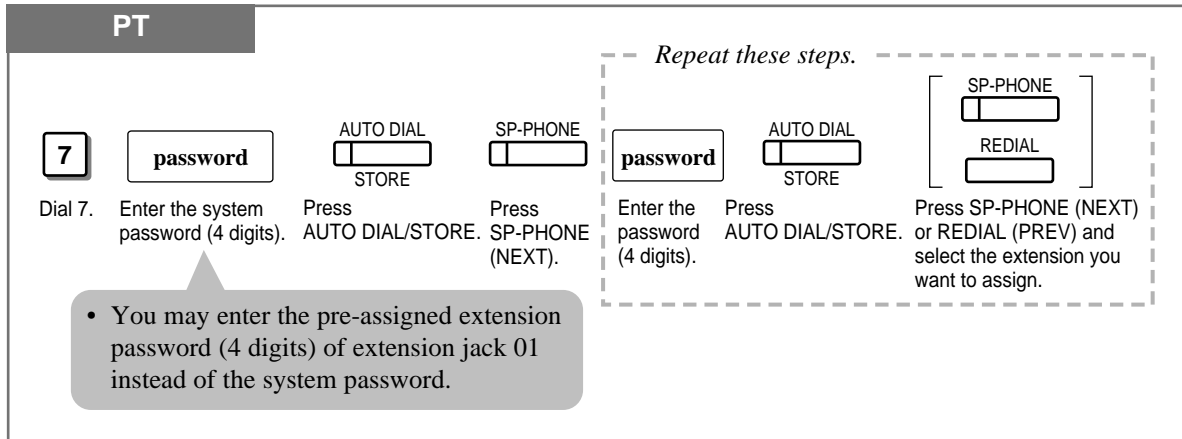

- Be sure the handset is on the cradle and the SP-PHONE button is off.
- To program, set the MEMORY switch on the proprietary telephone to “PROGRAM” or press the PROGRAM button on the KX-T7300 series.
- After programming, return the MEMORY switch to the “SET” position or press the PROGRAM button on the KX-T7300 series.
- The extension number is displayed in the order of the jack number when you press the NEXT or PREV button.
- In the Account Code Verify–Toll mode, you should not assign similar numbers as the emergency call codes. For example, if “911” is assigned as an emergency code, and you assign “9111” as an extension password, the system regards the entered number, “9111”, as the emergency code.
- To erase an incorrect entry, press the CLEAR (TRANSFER) button and enter a new number.



- 1.7 Useful Features, “Calling Using Your Privileges at Another Extension (Walking COS)”
- See the Installation Manual, Section 3, “Extension Password/System Password”.
- See the Installation Manual, Section 3, “Toll Restriction Override by Extension Password”.
- See the Installation Manual, Section 3, “Walking COS”.

1.9 *DSS Console Features*

With a Direct Station Selection (DSS) Console, model KX-T7340 and KX-T7040, you can make or transfer calls and access system features with the touch of a button. The DSS Console must be connected to a Panasonic Advanced Hybrid System and paired with a PT. System Programming is required to designate the extension jacks of the DSS Console. With a paired telephone, you can carry out the following operations using the DSS Console.

- Direct access to an extension (Direct Station Dialing)
- Quick access to an external party (One-Touch Dialing)
- Quick access to a system feature (One-Touch Access for System Features)
- Easy transfer to an extension (Call Transfer)
- Quick access to the day mode (Time (Day/Night/Lunch) Service) (Operator/Manager only)
- Quick access to the night mode (Time (Day/Night/Lunch) Service) (Operator/Manager only)
- Quick access to the lunch mode (Time (Day/Night/Lunch) Service) (Operator/Manager only)
- Quick setting of the Remote Station Lock Control (Remote Station Lock Control) (Operator/Manager only)



- The KX-T7340/KX-T7040 and Proprietary Telephone (PT) should be placed side by side on your desk.
- A single line telephone cannot be utilized with the KX-T7340/KX-T7040.
- For System Programming, please refer to the Installation Manual.

Initial Settings

PF buttons are provided with no default settings, while each DSS button has a default setting as follows.

DSS 01–24: extension numbers 101–124

DSS 25–32: no default settings

To meet your various needs, DSS buttons can be changed to other function buttons. Every DSS or PF button can be assigned to another extension number, telephone number or feature number by Initial Settings.







- Be sure the handset is on the cradle and the SP-PHONE button is off.
- To program, set the MEMORY switch on the proprietary telephone to “PROGRAM” or press the PROGRAM button on the KX-T7300 series.
- After programming, return the MEMORY switch to the “SET” position or press the PROGRAM button on the KX-T7300 series.
- As to the buttons on your DSS Console, please refer to your DSS Console manual.

1.9 DSS Console Features

Extension Number Assignment

You can assign a desired number to a DSS button.

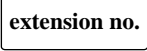

PT and DSS Console

[DSS Console]	[Paired telephone]	[Paired telephone]	[Paired telephone]	Repeat these steps to program numbers for other DSS buttons.
				
Press the desired DSS button.	Dial 1.	Enter the desired extension number (100 through 199).	Press AUTO DIAL/STORE.	

One-Touch Dialing Assignment

You can assign a DSS or PF button as a One-Touch Dialing button. The number can be an extension number or a telephone number. Up to 16 digits can be stored in each memory location.

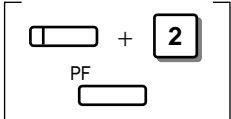
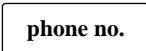
PT and DSS Console



[DSS Console and Paired telephone]	[Paired telephone]	[Paired telephone]	Repeat these steps to program numbers for other DSS or PF buttons.
			
Press the desired DSS button (on the DSS Console) and dial 2 (on the paired telephone), or press the PF button (on the DSS Console).	Enter the desired number.	Press AUTO DIAL/STORE.	

• When you assign an outside phone number, you must enter a line access code first.

One-Touch Access Assignment for System Features

You can assign a desired feature to a DSS or PF button.

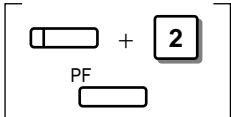
PT and DSS Console

[DSS Console and Paired telephone]	[Paired telephone]	[Paired telephone]	Repeat these steps to program numbers for other DSS or PF buttons.
			
Press the desired DSS button (on the DSS Console) and dial 2 (on the paired telephone), or press the PF button (on the DSS Console).	Enter the desired feature number.	Press AUTO DIAL/STORE.	

• If you wish to access the “Paging — All extensions” feature, enter feature number 330.

1.9 DSS Console Features

Day, Night and Lunch Buttons Assignment (Operator/Manager only)

You can assign a DSS button as the Day, Night or Lunch button. Simply pressing the assigned button sets the day, night or lunch mode.

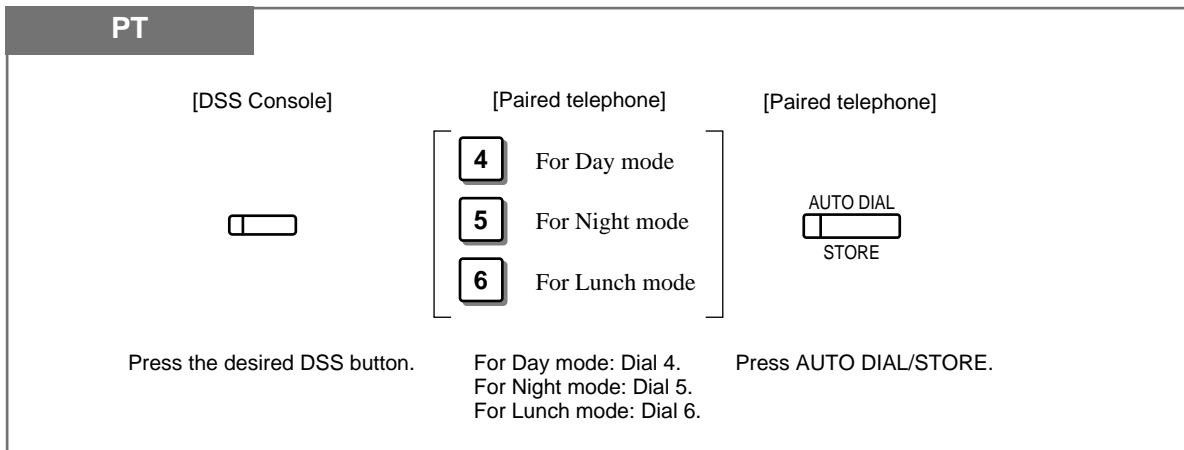

- See the Installation Manual, Section 3, "Time (Day/Night/Lunch) Service".

Station Lock Button Assignment (Operator/Manager only)

You can assign the Station Lock button to a DSS button for the remote station lock control feature.

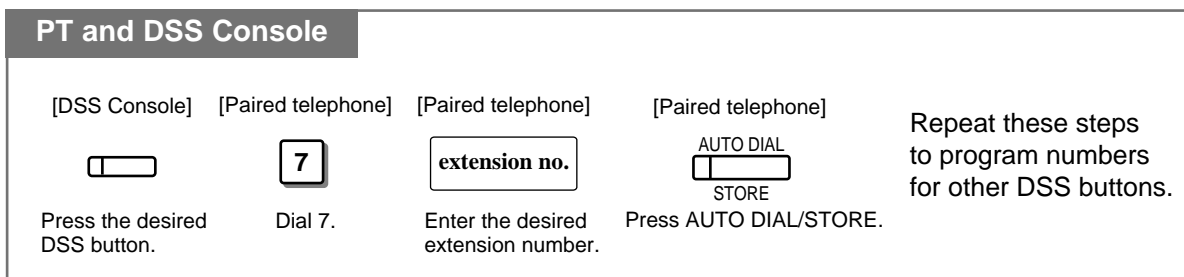

To cancel after programming

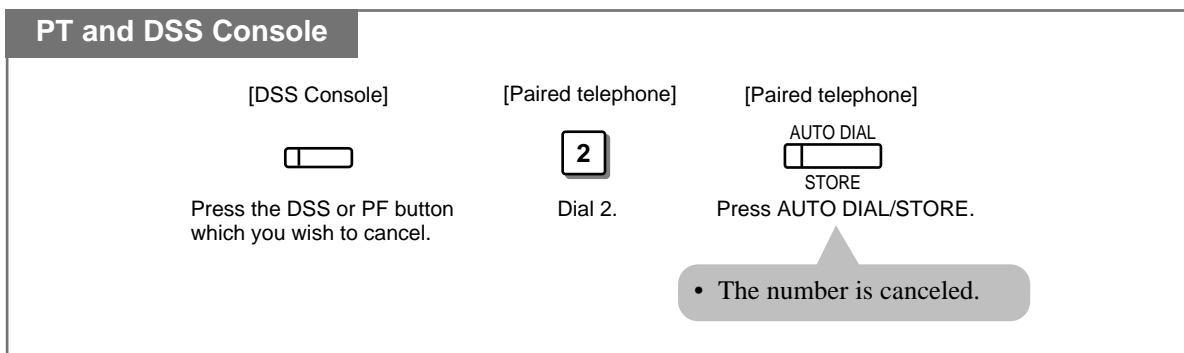

1.9 DSS Console Features



- DSS buttons can be changed to any of the following function buttons by Initial Settings.
 - a) *Another* DSS Button (Every DSS button can be assigned to another extension number.)
 - b) One-Touch Dialing Button
 - c) Day Button (Operator/Manager only)
 - d) Night Button (Operator/Manager only)
 - e) Lunch Button (Operator/Manager only)
 - f) Station Lock Button (Operator/Manager only)
- PF buttons can be changed to One-Touch Dialing buttons by Initial Settings.
- When the STORE button is pressed after programming, you will hear beep tones as follows.
 - 1 beep: The entry is different from the one that was stored previously.
 - 2 beeps: The entry is the same as the previously stored one.
- You can check the stored data by pressing the desired button while on-hook. The data will be displayed.



- 1.2 Proprietary Telephone Settings, “Customizing the Buttons on Your Telephone”,
DSS Button,
One-Touch Dialing Button

Direct Station Dialing

An extension can be called and accessed, by simply pressing a DSS button. The BLF shows if the extension is engaged.

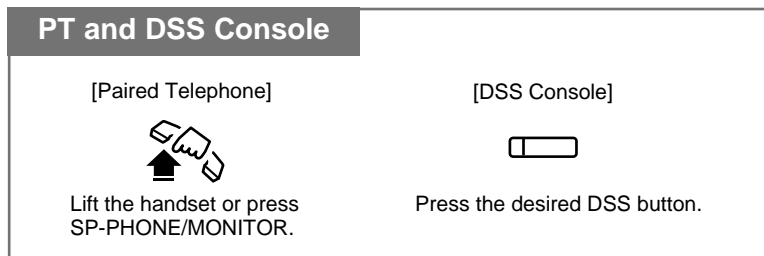

One-Touch Dialing

The stored number is dialed automatically by pressing a programmed DSS or PF button.

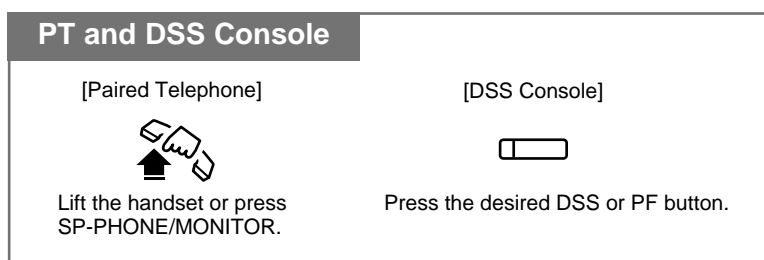

1.9 DSS Console Features

One-Touch Access for System Features

You can access system features by pressing a programmed DSS or PF button.

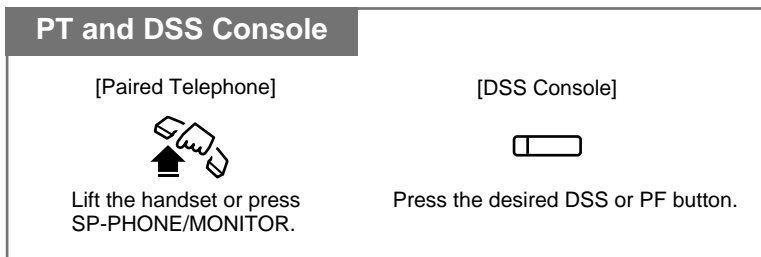

Call Transfer

A call can be transferred to an extension using a DSS button.

Without Transfer

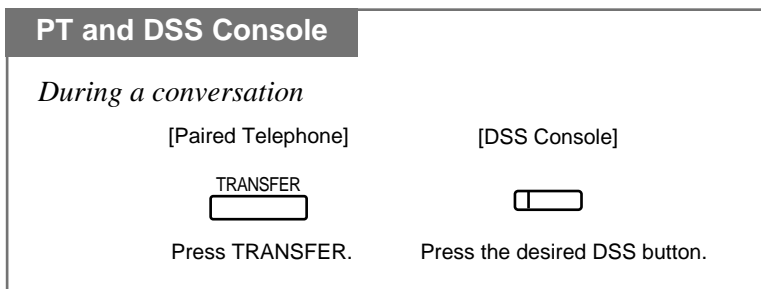

With Transfer

An outside call can be transferred to an extension using a one-touch operation.
The One-Touch Transfer function must be set by System Programming.

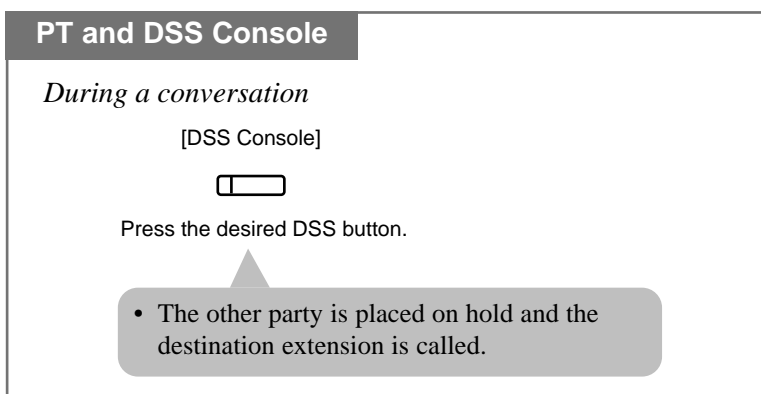

Section 2
Appendix

2.1 Tone / Ring Tone List

< TONE >

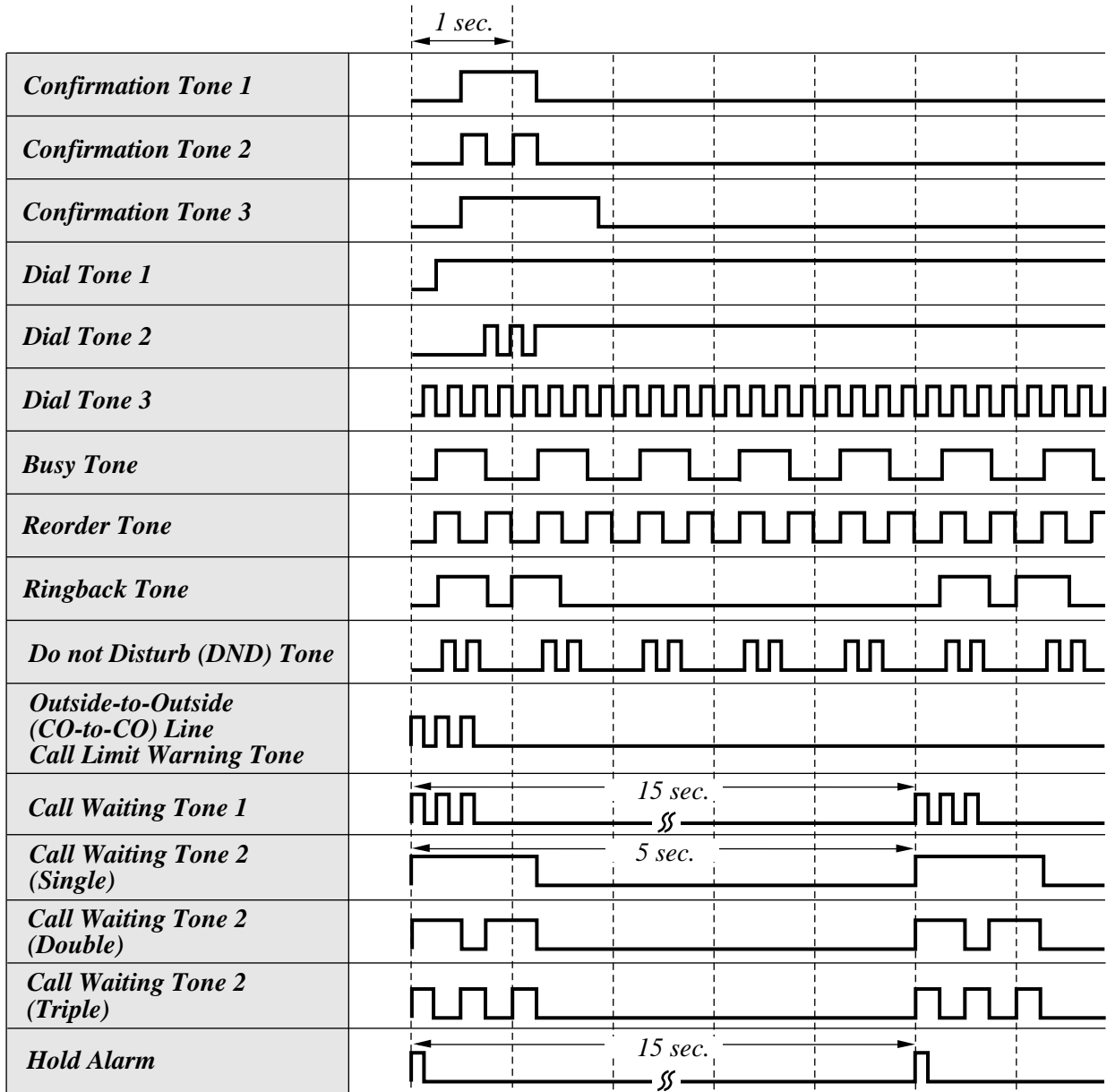

< RING TONE >

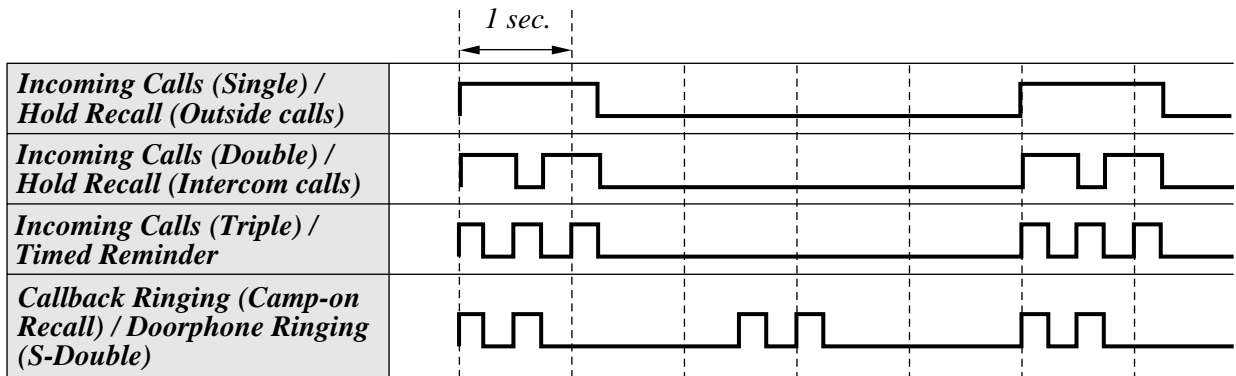

2.2 LED Indication

The Light Emitting Diode (LED) button indicate the line conditions by using lighting patterns.

Flashing light patterns

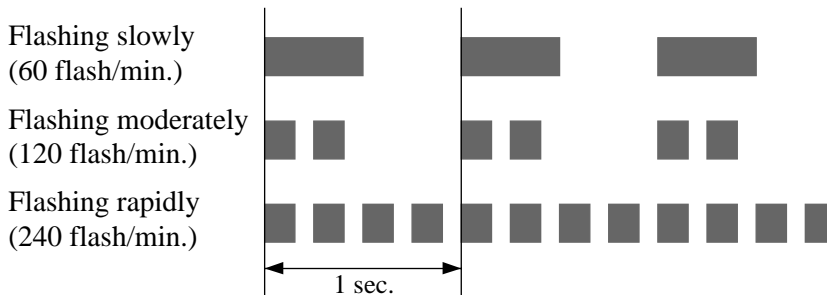

LED Indication on the INTERCOM Button

The table below shows the lighting patterns for intercom line conditions.

INTERCOM button	Intercom Line Condition
Off	Idle
Green On	You are using the line.
Flashing Green Slowly	You are holding a line.
Flashing Green Moderately	Intercom call exclusive hold
Flashing Green Rapidly	Incoming intercom/doorphone call

LED Indication on the CO Button

The table below shows the lighting patterns for outside (CO) line conditions.

CO Button	Outside (CO) Line Condition
Off	Idle
Green On	I-use
Flashing Green Slowly	I-hold / Hold Recall
Flashing Green Moderately	I-exclusive hold / Outside-to-outside (CO-to-CO) line call / Conference, Unattended
Flashing Red Rapidly	Incoming call
Red On	Other-use
Flashing Red Slowly	Other hold*

— Item with a * is only available on Another CO.

BLF on DSS Button

The Busy Lamp Field (BLF) indicator button is red when the corresponding extension is busy. This is available for flexible CO buttons assigned as DSS buttons on proprietary telephones and DSS buttons on DSS console.

2.3 Feature Number List

Feature Numbers and Additional Required Digits

FEATURE	NUMBER	ADDITIONAL REQUIRED DIGITS
Absent Message Capability set / cancel	75	1-6 / 0 + #
Account Code Entry for an SLT	49 or * *	Account code
Call Forwarding set / cancel	71	1-3 + desired number / 0 + #
Call Forwarding — Follow Me set / cancel	71	5 + EXTN. (extension no.) / 8 + #
Call Hold (Hold Mode 2 or 3) for an SLT	20	
Call Hold, Retrieve outside call / intercom call	53 / 5	CO (outside line no.) / EXTN.
Call Park / Call Park Retrieve	22 / 52	0-9
Call Pickup, Directed	4	EXTN.
Call Pickup, Group	40	
Call Pickup Deny set / cancel	72	1 / 0 + #
Call Retrieving from TAM	4	
Call Waiting set / cancel for extensions	732	1 / 0 + #
Call Waiting set / cancel for outside (CO) lines	731	1 / 0 + #
Conference (5-party)	22*	phone no. + CONF
Data Line Security set / cancel	730	1 / 0 + #
Do Not Disturb (DND) set / cancel	71	4 / 0 + #
Doorphone Call calling / door open	31 / 55	1-4
Electronic Station Lockout set	77	0000-9999 twice + #
Electronic Station Lockout cancel	77	0000-9999 + #
Executive Busy Override Deny set / cancel	733	0 / 1 + #
Extension Number	100-199	
External Feature Access	6	
Log-In / Log-Out	736	0 / 1 + #
Message Waiting set / cancel	70	(1 + EXTN.) / (2 + EXTN.) + #
Message Waiting cancel all messages	70	0 + #
Operator Call	0	
Outgoing Message (OGM) recording / playback	9	0-2 / 3-4
Outward Dialing		
— Line Access, Automatic	9	
— Line Access, Outside (CO) Line Group	8	1-6

2.3 Feature Number List

FEATURE	NUMBER	ADDITIONAL REQUIRED DIGITS
Paging — All	33	* or 9
Paging — External	34	
Paging — Group all / particular	33	0 / 1–8
Paging — Answer	43	
Paging Deny set / cancel	734	1 / 0 + #
Personal Speed Dialing	1* or #	0–9
Personal Speed Dialing store	2*	(0–9) + phone no. + #
Personal Speed Dialing confirm	3*	0–9 + #
Pickup Dialing (Hot Line) assign / set / cancel for an SLT	74	2 + phone no. / 1 / 0 + #
Redial, Last Number for an SLT	## or 80	
Room Monitor set / cancel	735	1 / 0 + #
Station Feature Clear	79	#
System Speed Dialing for an SLT	*	00–99
Timed Reminder set	76	hhmm* + (0 / 1) + (1 / 2) + #
Timed Reminder cancel / confirm	76	2 / 3 + #
Timed Reminder, Remote cancel	764	EXTN. + # + 762#
Timed Reminder, Remote check	764	EXTN. + # + 763#
Timed Reminder, Remote set	764	EXTN. + # + 76 + hhmm* + (0 / 1) + (1 / 2) + #
Time Service set / cancel	78	1–3 / 0 + #
Voice Mail Integration set / cancel	719	1–2 / 0 + #
Walking COS	7*	Extension password + EXTN. + #

* hhmm

hh: hour (01 – 12) / mm: minute (00 – 59)

2.3 Feature Number List

Feature Numbers

FEATURE	NUMBER
<i>While a busy tone is heard</i>	
Automatic Callback Busy (Camp-On)	6
Busy Station Signaling (BSS)	2
Executive Busy Override	3
<i>While a Do Not Disturb tone is heard</i>	
Do Not Disturb (DND) Override	2
<i>During a call or while talking</i>	
Alternate Calling — Ring/Voice	✖
Conference	3
Door open	5
Pulse to Tone Conversion	✖#
<i>When the telephone is on-hook</i>	
Background Music (BGM) on/off	1
Time (Day/Night/Lunch) mode display	#
EXTN. and extension name/ Date (day/month) and time display/ date (month/day/year/day of the week) display changing	✖



- When “✖” or “#” are included in a feature number, users with rotary telephones cannot access the feature except for the ones which can use “0” instead of “#” .

2.4 Display Example

Due to the Bilingual Selection Feature, you can select the display in English or Russian. The left part is the English display and the right part is the Russian display.

ENGLISH DISPLAY	RUSSIAN DISPLAY	DESCRIPTION
Set Time & Date	УСТ. ВРЕМЕНИ / ДАТЫ	Factory setting. The system clock is not working properly.
Jan 1 12:00AM 1 Jan 20:00	ЯНВ 1 12:00ДП 1 ЯНВ 20:00	The current date and time using a 12-hour clock. The current date and time using a 24-hour clock. — Pressing “*” while on-hook alternates between this display and the following two displays.
Jan 1,1998 Thu	ЯНВ 1,1998 ЧЕТ	The current date and day of the week.
123: 123:Tony Viola	123: 123:Tony Viola	Making or receiving an intercom call. Also, displayed while on-hook. A name is not assigned. Making or receiving an intercom call or called by “Camp-On” (intercom recall). Also, displayed while on-hook. A name is assigned. Confirming key programming on a DSS or MESSAGE button.
101: Busy	101: ЗАНЯТО	The destination extension is busy.
101: DND	101: НЕ БЕСПОК.	The destination extension has set “Do Not Disturb (DND)”.
950-1001PP12345&	950-1001PP12345И	Confirming the key programming on the REDIAL, SAVE, or One-Touch Dialing button.
→123:Tony Viola	→123: Tony Viola	Making or receiving an intercom call after a call is forwarded. A name is assigned.
→101: Busy	→101: ЗАНЯТО	The destination extension is busy after a call is forwarded.
→101: DND	→101: НЕ БЕСПОК.	The destination extension has set “Do Not Disturb (DND)” after a call is forwarded.
Alarm 10:15AM	СИГНАД 10:15ДП	The “Timed Reminder” setting is completed or a “Timed Reminder” call was received (1-time mode). Confirming the “Timed Reminder” programming.
Alarm 10:15AM*	СИГНАД 10:15ДП*	The “Timed Reminder” setting is completed or a “Timed Reminder” call was received (everyday mode). Confirming the “Timed Reminder” programming.
Alarm Cancel	ОТМЕНА СИГНАДА	Canceled “Timed Reminder”.
Alarm Not Stored	СИГНАЛ НЕ СОХР.	Confirming “Timed Reminder” programming when it is not stored.
At Ext 101	НА АБН 101	Absent Message 3.

2.4 Display Example

ENGLISH DISPLAY	RUSSIAN DISPLAY	DESCRIPTION
Back at 11:00AM	ПРИДУ В 12:34ДП	Absent Message 4.
BGM off	ФОН-МУЗЫКА ВЫКЛ.	Stopped BGM.
BGM on	ФОН-МУЗЫКА ВКЛ.	Started BGM.
Busy	ЗАНЯТО	The called doorphone or external pager is in use.
Busy Ovrde Allow	ФОРС. ЗАНЯТ ВКЛ.	Canceled "Executive Busy Override Deny".
Busy Ovrde Deny	ФОРС. ЗАНЯТ ВЫКЛ.	Completed setting "Executive Busy Override Deny".
C.Pickup Allow	ПЕРЕХВАТ РАЗРЕШ.	Canceled "Call Pickup Deny".
C.Pickup Deny	ПЕРЕХВАТ ЗАПРЕЩ.	Completed setting "Call Pickup Deny".
Call on CO 1	ЗВ-К НА ГЛ 1	Called by an outside (CO) line.
Call Prked at 1	ЗВ-К ОСТАВ. НА 1	Completed setting "Call Park".
Callback All COs	ОТЗВОН ВСЕ ГЛ	Completed setting "Camp-On" when there is no idle outside (CO) line.
Callback CO 1	ОТЗВОН ГЛ 1	Completed setting "Camp-On".
Callback CO G1	ОТЗВОН ГЛ Г1	Completed setting "Camp-On".
Callback Ext 101	ОТЗВОН АБН 101	Completed setting "Camp-On".
CO 1	ГЛ 1	An idle outside (CO) line is seized.
CO 1 0:01'15	ГЛ 1 0:01'15	The duration time of incoming outside call.
CO 1 & CO 2	ГЛ 1 И ГЛ 2	A Conference with two outside (CO) lines. Called by hold recall. — "Conference, Unattended".
CO 3 Free	ГЛ 3 СВОБОДНА	Called by "Camp-On" (Outside (CO) line recall).
Conference	КОНФЕРЕНЦИЯ	Confirming key programming on the Conference button.
CO in Use	ГЛ ЗАНЯТА	The selected outside (CO) line is busy.
CO Not Assigned	ГЛ НЕ НАЗНАЧЕНА	The desired outside (CO) line is restricted (not assigned).
CW(CO) Off	ОВ (ГЛ) ВЫКЛ.	Canceled "Call Waiting" for outside calls.
CW(CO) On	ОВ (ГЛ) ВКЛ.	Completed setting "Call Waiting" for outside calls.
CW(Ext) Off	ОВ (АБН) ВЫКЛ.	Canceled "Call Waiting" for intercom calls.
CW(Ext) On	ОВ (АБН) ВКЛ.	Completed setting "Call Waiting" for intercom calls.
Data Mode Off	ЛН ДАННЫХ ВЫКЛ.	Canceled "Data Line Security".
Data Mode On	ЛН ДАННЫХ ВКЛ.	Completed setting "Data Line Security".
Day Mode	ДНЕВНОЙ РЕЖИМ	Day mode status. — "Time (Day/Night/Lunch) Service"
Do Not Disturb	НЕ БЕСПОКОЧТЬ	Confirming the key programming on the FWD/DND button. Completed setting "Do Not Disturb (DND)".

2.4 Display Example

ENGLISH DISPLAY	RUSSIAN DISPLAY	DESCRIPTION
D - Opener 1-On	ДВЕР.ЗАМОК 1-ВКЛ	Completed opening the door.
Door Phone 1	ДОМОФОМ 1	Making or receiving a doorphone call.
Ext101 & CO 1	АБН101 И ГЛ 1	Conference with an extension and outside (CO) line.
Ext101 & Ext102	АБН101 И АБН102	Conference with two extensions.
Enter ACCNT Code	ВВЕДИ РАССЧ. КОД	Pressing the FWD/DND or PAUSE button. — “Account Code Entry”
Ext Data Clear	АБН ДАННЫЕ ОЧИСТ	Executed “Station Feature Clear”.
External Page	ВЫЗОВ ВНЕШЦИЙ.	Accessed to “Paging — External”.
FWD(ALL) All COs	ФВД(ВСЕ) ВСЕ ГЛ	Completed setting “Call Forwarding — to Outside (CO) Line”. Confirming the key programming on the FWD/DND button.
FWD (All) CO G1	ФВД(ВСЕ) ГЛ Г1	Completed setting “Call Forwarding — to Outside (CO) Line” (- to outside (CO) line group). Confirming the key programming on the FWD/DND button.
FWD(ALL) Ext101	ФВД(ВСЕ) АБН101	Completed setting “Call Forwarding — All Calls”. Confirming the key programming on the FWD/DND button.
FWD(B/NA) Ext101	ФВД(З/НО) АБН101	Completed setting “Call Forwarding — Busy or No Answer”. Confirming the key programming on the FWD/DND button.
FWD(From) Ext101	ФВД(ОТ) АБН101	Completed setting “Call Forwarding — Follow Me”.
FWD/DND Cancel	ФВД/НБ ОТМЕНА	Canceled “Call Forwarding” or “Do Not Disturb (DND)”.
FWD V.M. Off	ФВД Г.П. ВЫК	Canceled “Call Forwarding to Voice Mail”.
FWD V.M. On	ФВД Г.П. ВКЛ	“Call Forwarding to Voice Mail — setting A” is set.
FWD V.M.(#6) On	ФВД Г.П. (#6) ВК	“Call Forwarding to Voice Mail — setting B” is set.
Gone Home	УШЕЛ ДОМОЙ	Absent Message 2.
Group Log In	ВХОД В ГРУППУ	“Log-In” is set.
Group Log Out	ВЫХОД ИЗ ГРУППЫ	“Log-Out” is set.
In a Meeting	НА ВСТРЕЧЕ	Absent Message 6.
Locked : 1234	ЗАКРЫТО : 1234	Completed setting “Electronic Station Lockout”.
Lunch Mode	ОБЕДЕННЫЙ РЕЖИМ	Lunch mode status. — “Time (Day/Night/Lunch) Service”
Message Cancel	ОТМЕНА СООБЩЕНИЯ	Canceled Absent Message.

2.4 Display Example

ENGLISH DISPLAY	RUSSIAN DISPLAY	DESCRIPTION
MW at Ext 101	ОС НА АБН 101	Completed setting “Message Waiting”.
MW Not Accepted	ОС НЕ ПРИНЯТО	The “Message Waiting” setting was not accepted.
MW Cancelled	ОС ОТМЕНЕНО	Canceled “Message Waiting”.
Night Mode	ИОЧНОЙ РЕЖИМ	Night mode status. — “Time (Day/Night/Lunch) Service”
No Held Call	НЕТ УДЕРЖ. ЗВ-В	There is not a held call when retrieving a call on hold or parked call.
No Incoming Call	НЕТ ВХОДНЫХ ЗВ-В	There is not an incoming call when trying to pick up a call.
No Page	НЕТ ВЫЗОВА	When trying to answer a page, there is no call or someone has already answered the page.
Not Valid	НЕ ДОСТУПНО	Illegal operation.
Out Until 12/12	УШЕЛ ДО 12/12	Absent Message 5.
Paging All	ВЫЗОВ ВСЕ	Accessing “Paging — All”.
Paging All Ext	ВЫЗОВ ВСЕ АБН	Accessed “Paging — Group” (- to all extensions).
Paging Allow	ВЫЗОВ РАЗРЕШЕН	Canceled “Paging — Deny”.
Paging Deny	ВЫЗОВ ЗАПРЕЩЕН	“Paging — Deny” is set.
Paging Group 1	ВЫЗОВ ГРУП. 1	Accessed “Paging — Group” (- to a particular extension group).
Park at 1 N/A	ОСТ. НА 1 Н/П	The “Call Park” setting was not available.
PITS-PGM NO? →	СИСТ-ПРГ НЕТ?→	Entered the Station Programming mode.
PSD Set 1	ПСН УСТ 1	“Personal Speed Dialing” is set.
PSD 1 Not Stored	ПСН 1 НЕ СОХРАНЕ	Confirming the Personal Speed Dialing number.
RCL: Ext 101	ВЗТ: АБН 101	Called by transfer recall, without a name. — “Call Transfer”
Restricted	ЗАПРЕЩЕНО	The outgoing call is restricted.
Room Monitor Off	КОМН. МОНИТОР ВЫК	Canceled “Room Monitor”.
Room Monitor On	КОМН. МОНИТОР ВКД	“Room Monitor” is set.
Set COS Ext101	УСТ. К/ОБС АБН101	The Walking COS feature is set.
Transfer to CO	ПЕРЕВЕДЕН НА ГД	The destination extension has set “Call Forwarding — to Outside (CO) Line”.
Unlocked	ОТКРЫТО	Canceled “Electronic Station Lockout”.
Will Return Soon	СКОРО ВЕРНУСЬ	Absent Message 1.

2.5 Troubleshooting

If a power failure occurs...

Your system enables a conversation between a specific outside (CO) line and extension (Power Failure Transfer) and supports system data backup.

Power Failure Transfer

A specific extension can be automatically connected to a specific outside (CO) line. This provides outside (CO) line calls between the following extension and outside (CO) line.

Outside (CO) line 1 is connected to extension jack 01.

Outside (CO) line 4 is connected to extension jack 09.

- All other conversations will be disconnected during a power failure.
- Proprietary telephones (PT) cannot be used during a power failure. A single line telephone will work in the event of a power failure. Connect the single line telephone to the above jack.
- When power is restored after a power failure, your system automatically restarts, maintaining as much of the previous system data as possible.

Problem	Probable Cause	Possible Solution
Nothing is heard in the handsfree mode.	The “Headset” mode is selected.	When the headset is not used, set the mode to “Handset”. Refer to “When Using the Headset” in Proprietary Telephone Settings.
The unit does not ring.	<ul style="list-style-type: none">• An outside (CO) line number is not programmed.• The Ringer Volume is set to “OFF”.	<ul style="list-style-type: none">• To program outside (CO) line numbers, refer to the Installation Manual.• Increase the Ringer Volume. Refer to “Volume Control” in Proprietary Telephone Settings.
The display flashes the following message. <div style="border: 1px solid black; padding: 2px; display: inline-block;">Set Time & Date</div>	The system internal clock is not working properly.	Consult with an authorized Panasonic Factory Service Center.

Index

-
- A** Absent Message Capability 1-58
Account Code Entry 1-67
Adjustment → Control
Alarm Setting (Timed Reminder) 1-72
Alternate Calling — Ring/Voice 1-82
Answering → Receiving Calls
Automatic Callback Busy — Camp-On 1-30
Automatic Redial 1-27
- B** Background Music (BGM) 1-80
Busy Lamp Field (BLF) 2-3
Busy Station Signaling (BSS) 1-29
Button
 CONF (Conference)..... 1-11
 Day..... 1-100
 DSS (Direct Station Selection) 1-10
 Extension Button Confirmation 1-81
 Flexible CO 1-8
 Flexible DSS 1-8
 Flexible MESSAGE..... 1-8
 FWD/DND (Forward/Do Not Disturb) 1-12
 Group-CO (G-CO)..... 1-10
 Line Access 1-9
 Log-In/Log-Out 1-12
 Lunch 1-100
 MESSAGE..... 1-13
 Night 1-100
 One-Touch Dialing 1-11
 Other CO (O-CO) 1-9
 PROGRAM 1-4
 SAVE..... 1-12
 Single-CO (S-CO) 1-9
 Station Lock..... 1-100
 VOLUME control 1-15
- Call Transfer 1-102
Call Transfer – to Extension 1-42
Call Transfer – to Outside (CO) Line 1-44
Call Waiting..... 1-45
Call Waiting Tone Selection 1-7
Camp-On (Automatic Callback Busy) 1-30
Canceling
 Alarm Setting (Timed Reminder) 1-72
 Automatic Callback Busy — Camp-On 1-30
 BGM 1-80
 Call Forwarding 1-56
 Call Pickup Deny 1-37
 Call Waiting..... 1-45
 Data Line Security 1-77
 Do Not Disturb (DND) 1-69
 Electronic Station Lockout 1-91
 Executive Busy Override Deny 1-33
 Handsfree Answerback 1-35
 Message Waiting 1-65
 Microphone Mute 1-51
 Pickup Dialing 1-26
 Room Monitor 1-76
 Station Feature Clear 1-82
 Time (Day/Night/Lunch) Service Setting .. 1-95
 Timed Reminder, Remote 1-92
 Voice Mail Integration..... 1-86
- Checking
 Alarm Setting (Timed Reminder) 1-73
 Extension Button 1-81
 Message Waiting 1-66
 Personal Speed Dialing 1-25
 Self-Extension Number 1-80
 Time (Day/Night/Lunch) Service 1-74
 Time (Day/Night/Lunch) Service Setting .. 1-95
 Timed Reminder, Remote 1-92
- Clearing
 Message Waiting 1-66
 Station Feature Clear 1-82
- CONF (Conference) Button..... 1-11
Conference (3-party) 1-59
Conference (5-party) 1-62
Conference, Unattended 1-61
Confirmation → Checking
- Control
 Display Contrast 1-14
 Handset receiver volume 1-15
 Headset volume 1-15
 Ringer volume 1-15
 Speaker volume 1-15
- Customizing 1-5
- C** Call Forwarding 1-52
Call Hold 1-38
Call Hold Retrieve 1-40
Calling → Making Calls
Call Park 1-41
Call Pickup..... 1-36
 Call Retrieving from a TAM..... 1-37
 Denying/allowing 1-37
 Directed 1-36
 Group 1-36
Call Pickup Deny 1-37
Call Splitting 1-47
-

Index

- D** Data Line Security 1-77
- Date and Time Setting 1-90
- Day Button..... 1-100
- Direct Station Dialing 1-101
- Display
 - Absent Message 1-58
 - English 2-7
 - Programming Mode 1-4
 - Secret Dialing 1-71
 - Spanish..... 2-7
- Distinctive Dial Tone..... 1-88
- Do Not Disturb (DND) 1-69
- Do Not Disturb (DND) Override..... 1-70
- Door Opener 1-84
- Doorphone Call 1-83
- DSS Console Features 1-98
 - Call Transfer 1-102
 - Direct Station Dialing 1-101
 - Initial Settings 1-98
 - One-Touch Access for
 - System Features 1-102
 - One-Touch Dialing 1-101
- DSS (Direct Station Selection) Button 1-10

- E** Electronic Station Lockout 1-57
- Electronic Station Lockout
 - CANCEL ALL 1-91
- Emergency Call 1-21
- Exclusive Hold..... 1-39
- Executive Busy Override..... 1-31
 - Extension 1-31
 - Outside (CO) Line 1-32
- Executive Busy Override Deny 1-33
- Extension Button Confirmation 1-81
- Extension Password Set..... 1-97
- External Feature Access 1-79

- F** Flash..... 1-19
- Flexible CO Button 1-8
- Flexible DSS Button 1-8
- Flexible MESSAGE Button..... 1-8
- Forwarding a Call (Call Forwarding) 1-52
 - All Calls 1-53
 - Busy or No Answer 1-54
 - Cancel 1-56
 - Follow Me 1-55
 - To Outside (CO) Line 1-54
- FWD/DND (Forward/Do Not Disturb)
 - Button 1-12

- G** Group-CO (G-CO) Button..... 1-10

- H** Handsfree Answerback 1-35
- Handsfree Operation 1-20
- Hold
 - Alarm 1-38, 1-39, 2-2
 - Call (Call Hold) 1-38
 - Call Splitting 1-47
 - Call Waiting..... 1-46
 - Conference (3-party) 1-59
 - Conference (5-party) 1-62
 - External Feature Access 1-79
 - Exclusively (Exclusive Hold) 1-39
 - in System Parking Area (Call Park) 1-41
 - Recall 1-38, 1-39, 1-40, 1-41, 1-61, 2-2
 - Retrieving (Call Hold Retrieve) 1-40
 - Transferring after paging 1-50

- I** Idle Line Preference..... 1-5
- Initial Settings 1-98
 - Day, Night and Lunch Buttons
 - Assignment 1-100
 - Extension Number Assignment 1-99
 - One-Touch Access Assignment
 - for System Features 1-99
 - One-Touch Dialing Assignment 1-99
 - Station Lock Button Assignment..... 1-100
 - To cancel after programming 1-100
- Intercom Alert Assignment 1-7
 - Tone Call 1-7
 - Voice Call 1-7
- Intercom Calling 1-16

Index

-
- L** Last Number Redial..... 1-27
LED Indication 2-3
 CO Button 2-3
 INTERCOM Button..... 2-3
Lever
 CONTRAST 1-14
 HANDSET/HEADSET 1-14
 HANDSET VOLUME..... 1-15
 RINGER volume 1-15
 VOLUME control 1-15
Line
 Call Transfer – to Outside (CO) Line 1-44
 Data Line Security 1-77
 Forwarding a Call (Call Forwarding) –
 To Outside (CO) Line 1-54
 Idle Line Preference..... 1-5
 Line Access Buttons 1-9
 Making Outside Calls Using
 Automatic Line Access 1-18
 Making Outside Calls Using
 Individual Line Access 1-18
 Making Outside Calls Using Individual
 Outside (CO) Line Group Access 1-19
 No Line Preference 1-5, 1-6
 Outside (CO) Line Ringing Selection 1-6
 Outside-to-Outside (CO-to-CO) Line
 Call Limit Warning Tone 2-2
 Preferred Line Assignment — Incoming.... 1-6
 Preferred Line Assignment — Outgoing.... 1-5
 Prime Line Preference 1-5, 1-6
 Ringing Line Preference 1-6
 Line Access Buttons 1-9
 Lockout 1-89
 Log-In/Log-Out 1-75
 Log-In/Log-Out Button 1-12
 Lunch Button 1-100

M Making Calls
 Account Codes (Account Code Entry) 1-67
 Automatic Line Access 1-18
 Doorphone Call 1-83
 Emergency Call 1-21
 Handsfree Operation 1-20
 Individual Line Access 1-18
 Individual Outside (CO) Line
 Group Access..... 1-19
 Intercom..... 1-16
 Operator Call 1-17
 Outside 1-17
 Personal Speed Dialing 1-24
 Redialing Automatically
 (Automatic Redial) 1-27
 Redialing the Last Number Dialed
 (Last Number Redial) 1-27
 Redialing the Saved Number
 (Saved Number Redial) 1-28
 Simply Going Off-Hook
 (Pickup Dialing) 1-26
 Simply Pressing a Button
 (One-Touch Dialing) 1-22
 System Speed Dialing 1-23
 Your Privileges at Another Extension
 (Walking COS) 1-87
Manager Service Features 1-90
 Date and Time Setting 1-90
 Electronic Station Lockout
 – CANCEL ALL 1-91
 Extension Password Set..... 1-97
 Outgoing Message (OGM) 1-93
 Remote Station Lock 1-94
 Time (Day/Night/Lunch)
 Service Setting 1-95
 Timed Reminder, Remote
 (Wake-Up Call) 1-91
MEMORY switch 1-4
Message (MESSAGE)
 Absent 1-58
 Button 1-13
 Notification (Message Waiting)..... 1-65
 Outgoing 1-93
 Voice Mail 1-85
MESSAGE Button..... 1-13
Message Waiting 1-65
Microphone Mute 1-51
Mixed Station Dialing 1-78
Mode
 Automatic 1-95
 Day 1-74, 1-95
 Forced 1-67
 Lunch 1-74, 1-95
 Manual 1-95
 Night..... 1-74, 1-95
 Option 1-67
 Verify-All 1-67
 Verify-Toll..... 1-67
 Without Transfer 1-43
 With Transfer..... 1-43
-

Index

- N** Night Button 1-100
No Line Preference..... 1-5, 1-6
- O** One-Touch Access for
 System Features 1-13, 1-102
One-Touch Dialing..... 1-22, 1-101
One-Touch Dialing Button 1-11
Operator Call 1-17
Operator Service Features 1-90
 Date and Time Setting 1-90
 Electronic Station Lockout
 – CANCEL ALL 1-91
 Outgoing Message (OGM) 1-93
 Remote Station Lock 1-94
 Time (Day/Night/Lunch)
 Service Setting 1-95
 Timed Reminder, Remote
 (Wake-Up Call) 1-91
Other CO (O-CO) Button 1-9
Outgoing Message (OGM) 1-93
Outside Calling 1-17
 Automatic Line Access 1-18
 Individual Line Access 1-18
 Individual Outside (CO) Line
 Group Access..... 1-19
Outside (CO) Line Ringing Selection 1-6
- P** Paging 1-48
 All extensions 1-48
 All extensions & External 1-49
 Answering 1-49
 Deny..... 1-51
 External 1-48
 Group 1-48
 Room Monitor 1-76
 Transferring 1-50
Paralleled Telephone Connection 1-78
Personal Speed Dialing 1-24
Pickup Dialing 1-26
Power Failure Transfer..... 1-89, 2-11
Preferred Line Assignment — Incoming 1-6
 No Line Preference 1-6
 Prime Line Preference 1-6
 Ringing Line Preference 1-6
Preferred Line Assignment — Outgoing..... 1-5
 Idle Line Preference..... 1-5
 No Line Preference 1-5
 Prime Line Preference 1-5
Prime Line Preference 1-5, 1-6
PROGRAM button 1-4
Programming Mode 1-4
Proprietary Telephone Setting
 Data Default Set..... 1-7
Pulse to Tone Conversion 1-81
- R** Receiving Calls 1-34
 Automatic Callback Busy
 — Camp-On..... 1-30
 Call Pickup..... 1-36
 Call Waiting 1-45, 1-46
 Doorphone Call 1-83
 Handsfree Answerback 1-35
 Paging 1-49
Redial
 Automatic 1-27
 Last Number 1-27
 Saved Number 1-28
Remote Station Lock 1-94
Restoring the MESSAGE Button 1-13
Ringing Line Preference 1-6
Ringing Pattern Selection 1-88
Ring Tone 2-2
 Callback Ringing (Camp-on Recall) 2-2
 Doorphone Ringing 2-2
 Hold Recall 1-38, 1-39, 1-40, 1-41, 1-61, 2-2
 Incoming Calls..... 2-2
 Timed Reminder 2-2
Room Monitor 1-76

Index

- S** SAVE Button 1-12
Saved Number Redial 1-28
Secret Dialing 1-71
Self-Extension Number Confirmation 1-80
Single-CO (S-CO) Button 1-9
Station Feature Clear 1-82
Station Lock Button..... 1-100
Storing
 Personal Speed Dialing 1-24
 Pickup Dialing 1-26
 Saved Number Redial 1-28
 System Speed Dialing 1-23
Symbol 1-2
System Speed Dialing 1-23
- T** Telephone 1-2, 1-78
Timed Reminder (Alarm Setting) 1-72
Timed Reminder, Remote
 (Wake-Up Call) 1-91
Time (Day/Night/Lunch) Service Setting 1-95
Tone 2-2
 Alarm 1-4
 Busy 1-16, 2-2
 Call Waiting..... 2-2
 Call Waiting Tone Selection 1-7
 Confirmation 1-4, 1-16, 2-2
 Dial 1-88, 2-2
 Distinctive Dial Tone..... 1-88
 Do not Disturb (DND) 1-16, 2-2
 Hold Alarm 1-38, 1-39, 2-2
 Pulse to Tone Conversion 1-81
 Reorder 2-2
 Ringback..... 1-16, 2-2
 Outside-to-Outside (CO-to-CO) Line
 Call Limit Warning 2-2
 Tone Call 1-7
Tone Call 1-7
Transferring
 after paging (Paging and Transfer) 1-50
 One-Touch Transfer..... 1-43
 Power Failure 1-89, 2-11
 Screened..... 1-42
 to an Extension 1-42
 to an Outside (CO) Line 1-44
 Unscreened 1-42
 Using a DSS button 1-43
 Without Transfer 1-43, 1-102
 With Transfer 1-43, 1-102
- V** Voice Call 1-7
Voice Mail Integration..... 1-85
Volume Control (VOLUME) 1-15
 Button 1-15
 Handset receiver volume 1-15
 Headset volume 1-15
 Ringer volume 1-15
 Speaker volume 1-15
VOLUME Control Button 1-15
- W** Wake-Up Call
 Alarm Setting..... 1-72
 Timed Reminder, Remote 1-91
Walking COS..... 1-87

Memo

Memo

Memo

NOTE

You can identify the data of manufacturing by serial number which is marked on the right side of the main unit.

Serial number : X X XXXXXXXXXX

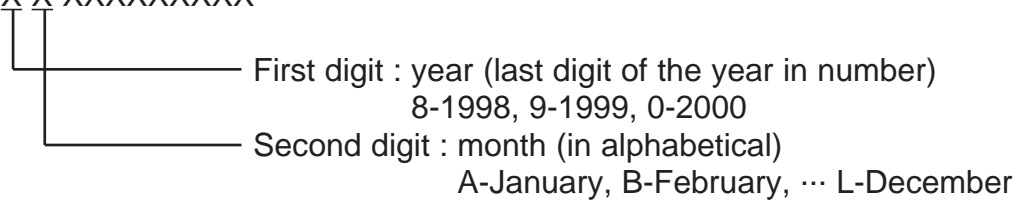

Matsushita Electric Industrial Co., Ltd.
Central P. O. Box 288, Osaka 530-91, Japan